

Product Data Sheet

INDOOR LIGHTING

HELEN 9W

CODE: 2027510

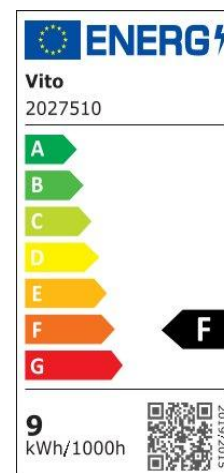

Area of application

IP54 Recessed LED Panel suitable to use in high-humidity places for indoor/outdoor lighting applications. Ceilings of corridors/rooms in offices, hospitals, schools, shopping malls, commercial areas..

Product Advantages

HELEN is a family of round waterproof recessed LED light fixtures equipped with LED sources in the backlight position. Housing of plastic board painted with sandblasted finishing in sand white. Diffuser of opal polycarbonate with anti-yellow treatment. DOB type of driver is included in the product.

Product Data Sheet

INDOOR LIGHTING

HELEN 9W

CODE: 2027510

Product Features

Electrical

Power: 9Watt
Voltage: 170-260V AC ~ 50/60Hz
Power Factor: >0.5
Electrical Protection: Class II
Surge Protection: --
Dimmability: NO
Switch Cycle: 30000 times

Material Characteristics

IP Class: IP54
IK Class: -
Material: PC
Ambient Temperature: -10°C<ta<+40°C
Body Color: WHITE
Product Size: Φ 118x24.5mm

Technical Drawing

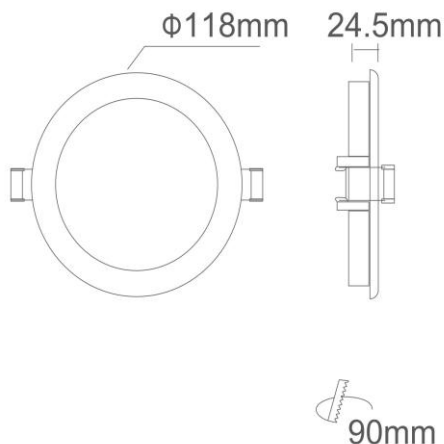

Lighting

Lumen: 765 Lm
Luminaire efficacy: 85 Lm/W
Colour Temperature: 6000K (COOL WHITE)
Beam Angle: 120°
CRI : Ra >80
Lifetime; 30000 Hours
EEL : F

Packing Informations

Pieces/Outbox: 40
Outbox Size: 390x266x266 mm
Outbox G.W.: 4,7 Kg
Outbox Volume: 0,0276 m³
Unit Weight: 117,5 gr
Barcode : 6970233832188

Light Distribution Curve

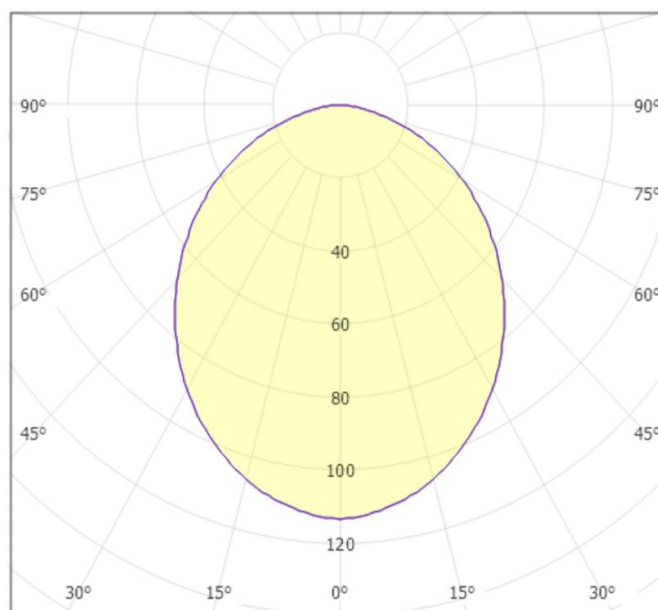

VITO EUROPE

102 Iztochna Tangenta str. 4th Floor

P.C. 1528, Sofia/Bulgaria

Phone: +359 2 4341575

E-mail: info@vitoeurope.com

www.vitolighting.com