

Product Data Sheet

INDOOR LIGHTING

HELEN 9W

CODE: 2027500

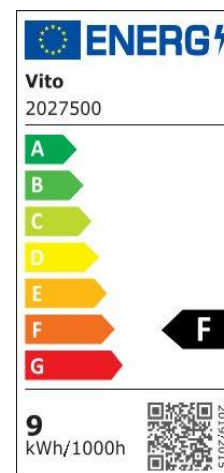

Area of application

IP54 Recessed LED Panel suitable to use in high-humidity places for indoor/outdoor lighting applications. Ceilings of corridors/rooms in offices, hospitals, schools, shopping malls, commercial areas..

Product Advantages

HELEN is a family of round waterproof recessed LED light fixtures equipped with LED sources in the backlight position. Housing of plastic board painted with sandblasted finishing in sand white. Diffuser of opal polycarbonate with anti-yellow treatment. DOB type of driver is included in the product.

Product Data Sheet

INDOOR LIGHTING

HELEN 9W

CODE: 2027500

Product Features

Electrical

Power: 9Watt

Voltage: 170-260V AC ~ 50/60Hz

Power Factor: >0.5

Electrical Protection: Class II

Surge Protection: --

Dimmability: NO

Switch Cycle: 30000 times

Material Characteristics

IP Class: IP54

IK Class: -

Material: PC

Ambient Temperature: -10°C<ta<+40°C

Body Color: WHITE

Product Size: Φ 118x24.5mm

Lighting

Lumen: 765 Lm

Luminaire efficacy: 85 Lm/W

Colour Temperature: 4000K (NATURAL WHITE)

Beam Angle: 120°

CRI : Ra >80

Lifetime; 30000 Hours

EEL : F

Packing Informations

Pieces/Outbox: 40

Outbox Size: 390x266x266 mm

Outbox G.W.: 4,7 Kg

Outbox Volume: 0,0276 m³

Unit Weight: 117,5 gr

Barcode : 6970233832171

Technical Drawing

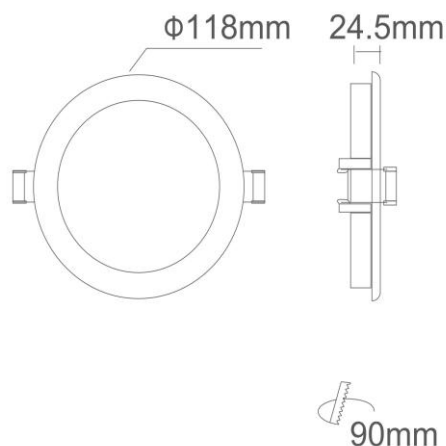

Light Distribution Curve

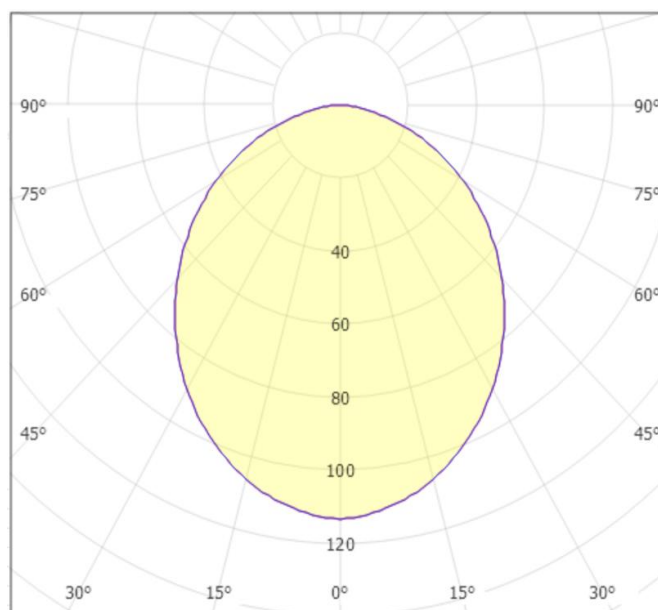

VITO EUROPE

102 Iztochna Tangenta str. 4th Floor

P.C. 1528, Sofia/Bulgaria

Phone: +359 2 4341575

E-mail: info@vitoeurope.com

www.vitolighting.com