

CATALOG

KM

# Lighting

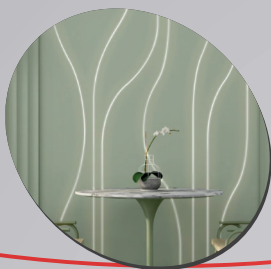
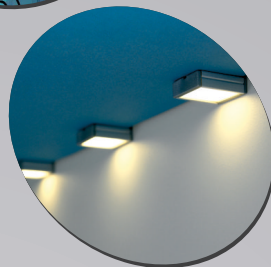
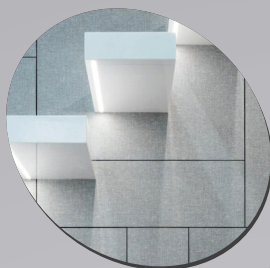

2025-2026



# Obsah

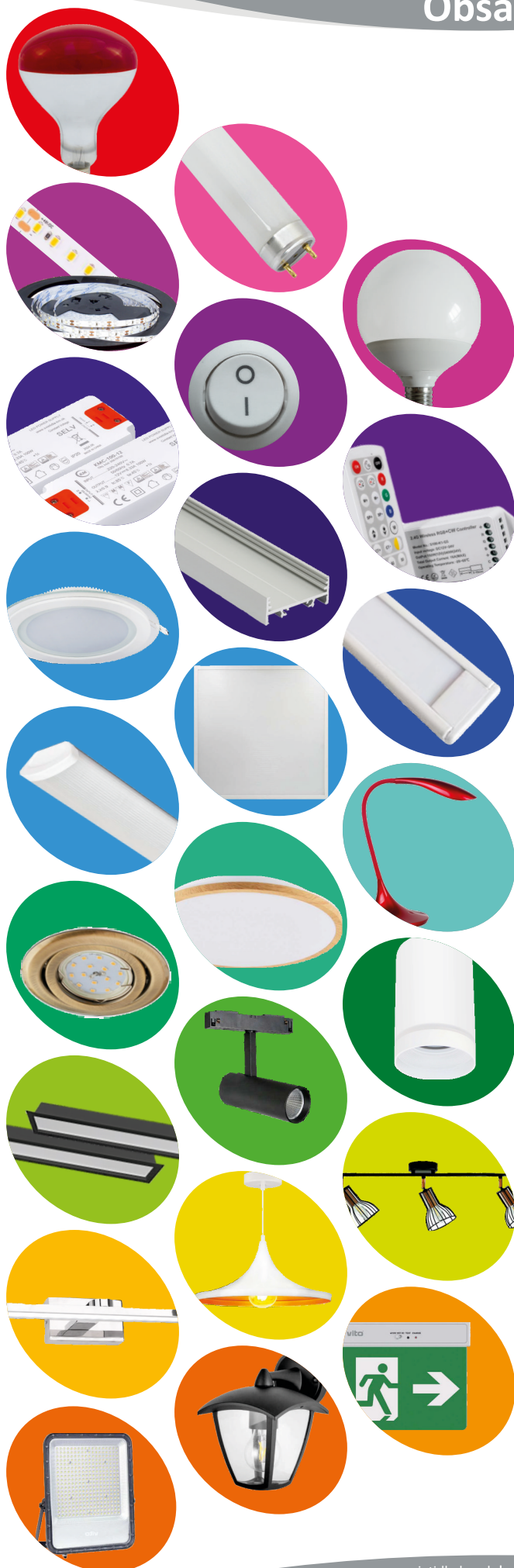

1	Žiarovky špeciálne
4	Žiarivky
4	Svetelné zdroje LED
20	LED pásy
39	Príslušenstvo LED
45	Ovládanie LED pásov
50	Napájacie zdroje LED
59	ALU profily LED
83	LED sady
100	LED svietidlá
119	Lampy
128	Stropnice
157	Podhľadové
164	Tuby
171	TRACK systém
174	Lineárne
183	Interiérové
191	Kuchynské
196	Kúpeľňové
204	Núdzové
207	Exteriérové
235	Príslušenstvo
239	Vzduchové výplne
241	Podpora predaja



## Žiarovky špeciálne

### Digestorové

materiál:  
sklo

E14

220-240 V



1000 h

2700 K

Ra = 100



E14 DIGESTOROVÁ



obj. kód	typ	W	lm	rozmer (mm)
12149040	E14-40W digest	40	400	D25x85



### Sporákové

300°

materiál:  
sklo

E14

220-240 V



1000 h

2700 K

Ra = 100



E14 300°



obj. kód	typ	W	lm	rozmer (mm)
12149115	E14-15W 300°	15	85	D22x48
12149125	E14-25W 300°	25	180	D22x48





E14 HRUŠKOVÁ

## Hruškové

materiál:  
sklo

E14

220-240 V



1000 h

2700 K

Ra = 100



obj. kód	typ	W	lm	rozmer (mm)
12149015	E14-15W hruš	15	110	D28x63
12149025	E14-25W hruš	25	190	D28x63



E14 TRUBKOVÁ



B15D TRUBKOVÁ

## Trubkové

materiál:  
sklo

220-240 V



1000 h

2700 K

Ra = 100



obj. kód	typ	pätica	W	lm	rozmer (mm)
12149207	E14-7W trub	E14	7	42	D18x56
12149210	E14-10W trub	E14	10	75	D18x56
12149215	E14-15W trub	E14	15	100	D18x56
12149220	E14-20W trub	E14	20	150	D18x56
12149315	B15D-15W trub	B15D	15	100	D18x56



# Žiarovky špeciálne



E27 INFRA CLEAR



## INFRA CLEAR

materiál:  
sklo

E27

240 V



5000 h

obj. kód	typ	W	rozmer (mm)
12275125	E27-125W INF C	125	D125x133
12275150	E27-150W INF C	150	D125x133
12275175	E27-175W INF C	175	D125x185
12275250	E27-250W INF C	250	D125x185



E27 INFRA RED



## INFRA RED

materiál:  
sklo

E27

240 V



5000 h

obj. kód	typ	W	rozmer (mm)
12275350	E27-150W INF R	150	D125x133
12275375	E27-175W INF R	175	D125x185
12275450	E27-250W INF R	250	D125x185





obj. kód	typ	W	lm	farba svetla	rozmer (mm)
11057084	T5-8W 840	8	550	neutrálna	D16x302,5
11057134	T5-13W 840	13	820	neutrálna	D16x531,5
11057214	T5-21W 840	21	1850	neutrálna	D16x863,2
11087104	T8-10W 840	10	410	neutrálna	D26x345
11087154	T8-15W 840	15	730	neutrálna	D26x450
11087184	T8-18W 840	18	1150	neutrálna	D26x600
11087186	T8-18W 865	18	1150	studená	D26x600
11087364	T8-36W 840	36	2760	neutrálna	D26x1200
11087366	T8-36W 865	36	2760	studená	D26x1200
11087584	T8-58W 840	58	4600	neutrálna	D26x1500



**T5**

**T8**

materiál:  
sklo

240 V



10000 h

Ra > 82



G45



P45



C35

**G45**

**P45**

**C35**

materiál:  
keramika, sklo

4 W

240 V

360 lm



25000 h

Ra > 80



obj. kód	typ	pätica	rozmer (mm)	farba svetla
10141043	P45-4W 3000K	E14	D45x86	teplá
10141046	P45-4W 6000K	E14	D45x86	studená
10142043	C35-4W 3000K	E14	D35x100	teplá
10142044	C35-4W 4000K	E14	D35x100	neutrálna
10142046	C35-4W 6000K	E14	D35x100	studená
10271043	G45-4W 3000K	E27	D45x86	teplá
10271046	G45-4W 6000K	E27	D45x86	studená



# Svetelné zdroje LED

**G45**  
**P45**  
**C35**

materiál:  
hliník, plast

5 W

170-260 V

500 lm



30000 h

Ra > 80



G45-5W



P45-5W



C35-5W

obj. kód	typ	pätica	rozmer (mm)	farba svetla
10271053	G45-5W 3000K	E27	D45x78	teplá
10271054	G45-5W 4500K	E27	D45x78	neutrálna
10271056	G45-5W 6500K	E27	D45x78	studená
10141053	P45-5W 3000K	E14	D45x78	teplá
10141054	P45-5W 4500K	E14	D45x78	neutrálna
10141056	P45-5W 6500K	E14	D45x78	studená
10142053	C35-5W 3000K	E14	D35x100	teplá
10142054	C35-5W 4500K	E14	D35x100	neutrálna
10142056	C35-5W 6500K	E14	D35x100	studená



**G45**  
**P45**  
**C37**  
**F37**

materiál:  
hliník, plast

7 W

170-260 V

700 lm



30000 h

Ra > 80



G45-7W



P45-7W



C37-7W



F37-7W

obj. kód	typ	pätica	rozmer (mm)	farba svetla
10271073	G45-7W 3000K	E27	D45x78	teplá
10271074	G45-7W 4500K	E27	D45x78	neutrálna
10271076	G45-7W 6500K	E27	D45x78	studená
10141073	P45-7W 3000K	E14	D45x78	teplá
10141074	P45-7W 4500K	E14	D45x78	neutrálna
10141076	P45-7W 6500K	E14	D45x78	studená
10142073	C37-7W 3000K	E14	D37x100	teplá
10142074	C37-7W 4500K	E14	D37x100	neutrálna
10142076	C37-7W 6500K	E14	D37x100	studená
10143073	F37-7W 3000K	E14	D37x100	teplá
10143074	F37-7W 4500K	E14	D37x100	neutrálna
10143076	F37-7W 6500K	E14	D37x100	studená





A60 KP

**A60 KP**materiál:  
keramika, sklo

E27

7 W

185-265 V

650 lm



30000 h

Ra &gt; 80



obj. kód	typ	rozmer (mm)	farba svetla
10270273	E27-7W KP 3000K	D60x110	teplá
10270274	E27-7W KP 4500K	D60x110	neutrálna
10270276	E27-7W KP 6500K	D60x110	studená



A60

**A60**materiál:  
hliník, plast

E27

170-260 V



30000 h

Ra &gt; 80



obj. kód	typ	W	lm	rozmer (mm)	farba svetla
10270173	E27-7W 3000K	7	700	D60x108	teplá
10270174	E27-7W 4500K	7	700	D60x108	neutrálna
10270176	E27-7W 6500K	7	700	D60x108	studená
10270113	E27-10W 3000K	10	1000	D60x108	teplá
10270114	E27-10W 4500K	10	1000	D60x108	neutrálna
10270116	E27-10W 6500K	10	1000	D60x108	studená
10270123	E27-12W 3000K	12	1200	D60x118	teplá
10270124	E27-12W 4500K	12	1200	D60x118	neutrálna
10270126	E27-12W 6500K	12	1200	D60x118	studená
10270153	E27-15W 3000K	15	1500	D60x110	teplá
10270154	E27-15W 4500K	15	1500	D60x110	neutrálna
10270156	E27-15W 6500K	15	1500	D60x110	studená



## Svetelné zdroje LED



G95



### G95

materiál:  
hliník, plast

E27

15 W



30000 h

Ra > 80

obj. kód	typ	U	lm	rozmer (mm)	farba svetla
10274253	G95-15W 3000K	170-260 V	1500	D95x130	teplá
10274254	G95-15W 4500K	170-260 V	1500	D95x130	neutrálna
10274256	G95-15W 6500K	170-260 V	1500	D95x130	studená



R50 6W

### R50

materiál:  
odliatok hliníka, plast

E14

6 W

170-260 V

600 lm



30000 h

Ra > 80

obj. kód	typ	rozmer (mm)	farba svetla
10145063	R50-6W 3000K	D50x85	teplá
10145064	R50-6W 4500K	D50x85	neutrálna
10145066	R50-6W 6500K	D50x85	studená





R63

## R63

materiál:  
odliatok hliníka,  
plast

E27

8 W

170-260 V

720 lm



30000 h

Ra > 80



obj. kód	typ	rozmer (mm)	farba svetla
10275083	R63-8W 3000K	D63x102	teplá
10275084	R63-8W 4500K	D63x102	neutrálna
10275086	R63-8W 6500K	D63x102	studená



GU10-2W MINI

## GU10 MINI

materiál:  
sklo

2 W

240 V

220 lm



30000 h

Ra > 80



obj. kód	typ	rozmer (mm)	farba svetla
10105023	GU10-2W MINI 3000K	D35x50	teplá
10105024	GU10-2W MINI 4500K	D35x50	neutrálna
10105026	GU10-2W MINI 6500K	D35x50	studená



## Svetelné zdroje LED



GU10-4,9W

GU10-3W

GU10-5W

GU10-7W

### GU10

materiál GU10-4,9W:

hliník, sklo

materiál GU10-3W,

GU10-5W a GU10-7W:

hliník, plast

170-260 V



120°

30000 h

Ra > 80

obj. kód	typ	W	lm	rozmer (mm)	farba svetla
10105493	GU10-4,9W 3000K	4,9	450	D50x55	teplá
10105494	GU10-4,9W 4500K	4,9	450	D50x55	neutrálna
10105496	GU10-4,9W 6500K	4,9	450	D50x55	studená
10105033	GU10-3W 3000K	3	270	D50x55	teplá
10105034	GU10-3W 4500K	3	270	D50x55	neutrálna
10105036	GU10-3W 6500K	3	270	D50x55	studená
10105053	GU10-5W 3000K	5	450	D50x55	teplá
10105054	GU10-5W 4500K	5	450	D50x55	neutrálna
10105056	GU10-5W 6500K	5	450	D50x55	studená
10105073	GU10-7W 3000K	7	600	D50x55	teplá
10105074	GU10-7W 4500K	7	600	D50x55	neutrálna
10105076	GU10-7W 6500K	7	600	D50x55	studená



GU10-60°

### GU10 60°

materiál:

hliník, plast



60°

30000 h

Ra > 80

obj. kód	typ	W	lm	U	rozmer (mm)	farba svetla
10105173	GU10-7W 3000K 60°	7	600	185-265 V	D50x55	teplá
10105174	GU10-7W 4500K 60°	7	600	185-265 V	D50x55	neutrálna
10105176	GU10-7W 6500K 60°	7	600	185-265 V	D50x55	studená





MR16-5W

## MR16

materiál:  
plast, sklo

5 W

450 lm

12 V



30000 h

Ra > 80



obj. kód	typ	rozmer (mm)	farba svetla
10165053	MR16-5W 3000K	D50x50	teplá
10165054	MR16-5W 4500K	D50x50	neutrálna
10165056	MR16-5W 6500K	D50x50	studená



G9-2,2W



G9-4W



G9-6W

## G9

materiál G9-2,2W:  
plast, sklo

materiál G9-4W, G9-6W:  
keramika, plast



35000 h

Ra > 80



obj. kód	typ	W	lm	U	farba svetla	rozmer (mm)
10096223	G9-2,2W 3000K	2,2	220	240 V	teplá	D27x55
10096224	G9-2,2W 4500K	2,2	220	240 V	neutrálna	D27x55
10096226	G9-2,2W 6500K	2,2	220	240 V	studená	D27x55
10096143	G9-4W KP 3000K	4	400	220-240 V	teplá	D15x50
10096144	G9-4W KP 4500K	4	400	220-240 V	neutrálna	D15x50
10096146	G9-4W KP 6500K	4	400	220-240 V	studená	D15x50
1518980	G9-6W 2700K	6	579	220-240 V	teplá	D16x60
1518990	G9-6W 4000K	6	593	220-240 V	neutrálna	D16x60
1519000	G9-6W 6400K	6	607	220-240 V	studená	D16x60



## Svetelné zdroje LED

### G9-8,5W

materiál:  
keramika, plast

8,5 W

220-240 V

50/60 Hz



25000 h

Ra > 80



G9-8,5W

obj. kód	typ	lm	farba svetla	rozmer (mm)
10096853	G9-8,5W 3000K	1100	teplá	D23x66
10096854	G9-8,5W 4000K	1100	neutrálna	D23x66
10096856	G9-8,5W 6500K	1100	studená	D23x66

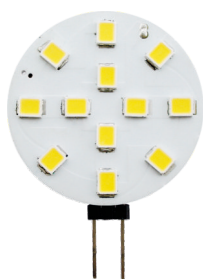

G4-2W

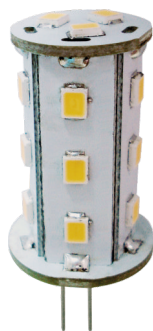

G4-2,5W



G4-4W

### G4

materiál:  
plast, keramika  
2835SMD

12 V

30000 h

Ra > 80

obj. kód	typ	W	lm	°	farba svetla	rozmer (mm)
10047123	G4-2W 3000K	2	180	120	teplá	9x27x38
10047124	G4-2W 4500K	2	180	120	neutrálna	9x27x38
10047126	G4-2W 6000K	2	180	120	studená	9x27x38
10046253	G4-2,5W 3000K	2,5	250	360	teplá	D16x45
10046043	G4-4W 3000K	4	400	360	teplá	D16x46,6
10046044	G4-4W 4500K	4	400	360	neutrálna	D16x46,6
10046046	G4-4W 6000K	4	400	360	studená	D16x46,6





G9-3,2W CAPSULED-2

**G9**

materiál:  
plast, keramika

**COB LED**

**3,2 W**

**220-240 V**

**50/60 Hz**



**35000 h**

**Ra > 80**



obj. kód	typ	lm	farba svetla	rozmer (mm)
1515440	G9-3,2W 2700K CAPSULED-2	325	teplá	D14x55
1515450	G9-3,2W 4000K CAPSULED-2	336	neutrálina	D14x55
1515460	G9-3,2W 6400K CAPSULED-2	345	studená	D14x55



G4-2W SMD

**G4**

materiál:  
silikón  
2835SMD

**12 V**

**Ra > 80**

**25000 h**



obj. kód	typ	W	lm	farba svetla	rozmer (mm)
1519120	G4-2W SMD 2700K	2	170	teplá	10x28x37
1519130	G4-2W SMD 4000K	2	175	neutrálina	10x28x37
1519140	G4-2W SMD 6400K	2	180	studená	10x28x37



E14-2W TR



E14-6W TR

## E14 TR

materiál:  
plast, keramika

220-240 V



30000 h

Ra > 80

obj. kód	typ	W	lm	rozmer (mm)	farba svetla
10146023	E14-2W TR 3000K	2	180	D18x49	teplá
10146024	E14-2W TR 4500K	2	180	D18x49	neutrálna
10146026	E14-2W TR 6500K	2	180	D18x49	studená
10146063	E14-6W TR 3000K	6	540	D16,2x50	teplá
10146064	E14-6W TR 4500K	6	540	D16,2x50	neutrálna
10146066	E14-6W TR 6500K	6	540	D16,2x50	studená



LEDISON-2 G45



LEDISON-2 P45



LEDISON-2 C35

## LEDISON-2 G45, P45, C35

materiál:  
hliník, sklo

4W

220-240 V



25000 h

Ra > 80

obj. kód	typ	pätica	lm	rozmer (mm)	farba svetla
1514460	LEDISON-2 C35-4W 2700K	E14	520	D35x97	teplá
1514470	LEDISON-2 C35-4W 4000K	E14	532	D35x97	neutrálna
1514520	LEDISON-2 P45-4W 2700K	E14	520	D45x76	teplá
1514530	LEDISON-2 P45-4W 4000K	E14	532	D45x76	neutrálna
1514550	LEDISON-2 G45-4W 2700K	E27	520	D45x75	teplá
1514560	LEDISON-2 G45-4W 4000K	E27	532	D45x75	neutrálna





LEDISONE-2 G45



LEDISONE-2 P45



LEDISONE-2 C35

## LEDISONE-2 G45, P45, C35

materiál:  
hliník, sklo

6W

220-240 V



25000 h

Ra > 80

obj. kód	typ	pätica	lm	rozmer (mm)	farba svetla
1518220	LEDISONE-2 C35-6W 2700K	E14	724	D35x97	teplá
1518230	LEDISONE-2 C35-6W 4000K	E14	736	D35x97	neutrálna
1518280	LEDISONE-2 P45-6W 2700K	E14	724	D45x76	teplá
1518290	LEDISONE-2 P45-6W 4000K	E14	736	D45x76	neutrálna
1518300	LEDISONE-2 G45-6W 2700K	E27	724	D45x75	teplá
1518310	LEDISONE-2 G45-6W 4000K	E27	736	D45x75	neutrálna



LEDISONE-2 A60

## LEDISONE-2 A60

materiál: sklo

E27

220-240 V



25000 h

Ra > 80

obj. kód	typ	W	lm	rozmer (mm)	farba svetla
1514430	LEDISONE-2 A60-8W 2700K	8	1000	D60x105	teplá
1514440	LEDISONE-2 A60-8W 4000K	8	1060	D60x105	neutrálna
1518200	LEDISONE-2 A60-10W 2700K	10	1250	D60x105	teplá
1518210	LEDISONE-2 A60-10W 4000K	10	1270	D60x105	neutrálna





## LEDISONE-2 G95

materiál: sklo

8W

E27

220-240 V



25000 h

Ra > 80



LEDISONE-2 G95



obj. kód	typ	lm	rozmer (mm)	farba svetla
1514610	LEDISONE-2 G95-8W 2700K	976	D95x135	teplá
1514620	LEDISONE-2 G95-8W 4000K	1000	D95x135	neutrálna



## LEDISONE-2 VINTAGE

materiál:  
hliník, sklo

E27

220-240 V



25000 h

Ra > 80

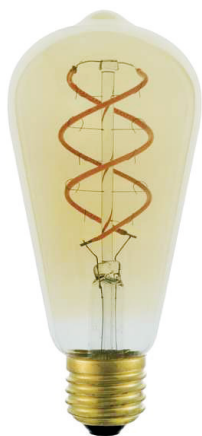

LEDISONE-2 VINTAGE ST64-4W



LEDISONE-2 VINTAGE G95-4W



LEDISONE-2 VINTAGE T30-5W

obj. kód	typ	W	lm	rozmer (mm)	farba svetla
1519170	LEDISONE-2 VINTAGE ST64-4W E27 2200K	4	400	D64x142	teplá
1519180	LEDISONE-2 VINTAGE G95-4W E27 2200K	4	428	D95x137	teplá
1519190	LEDISONE-2 VINTAGE T30-5W E27 2200K	5	425	D30x150	teplá





## LEDISONE-2 RETRO

materiál:  
hliník, sklo

E27

220-240 V

2500 K



25000 h

Ra > 80

LEDISONE-2 RETRO  
A60-6W E27 2500K

LEDISONE-2 RETRO  
A60-4W E27 2500K

LEDISONE-2 RETRO  
G45-2W E27 2500K

LEDISONE-2 RETRO  
ST64-6W E27 2500K

obj. kód	typ	W	lm	rozmer (mm)	farba svetla
1519200	LEDISONE-2 RETRO A60-6W E27 2500K	6	840	D60x105	teplá
1519210	LEDISONE-2 RETRO A60-4W E27 2500K	4	568	D60x105	teplá
1519220	LEDISONE-2 RETRO ST64-6W E27 2500K	6	862	D64x142	teplá
1519230	LEDISONE-2 RETRO G45-2W E27 2500K	2	300	D42x75	teplá



## LEDISONE-R

materiál:  
sklo

E27

8 W

220-240 V

2500 K



25000 h

Ra > 80

LEDISONE-R G95  
Obj. kód 1513540

LEDISONE-R G125  
Obj. kód 1513550

LEDISONE-R ST64  
Obj. kód 1513530

obj. kód	typ	lm	rozmer (mm)	farba svetla
1513530	LEDISONE-R ST64-8W 2500K	800	D64x142	teplá
1513540	LEDISONE-R G95-8W 2500K	800	D95x137	teplá
1513550	LEDISONE-R G125-8W 2500K	880	D125x175	teplá





## Svetelné zdroje LED

### SMART

materiál:  
hliník, plast

W+RGB

CCT  
3000 - 6500 K



E27

220-240 V



25000 h

Ra > 80



SAGA A60

SAGA G95



obj. kód	typ	W	lm	rozmer (mm)
1518700	SAGA A60-10W RGBW WIFI	10	850	D60x118
1518720	SAGA G95-14W RGBW WIFI	14	1260	D95x142



### SMART

materiál:  
hliník, plast

W+RGB

CCT  
3000 - 6500 K



GU10

220-240 V



25000 h

Ra > 80



SAGA GU10

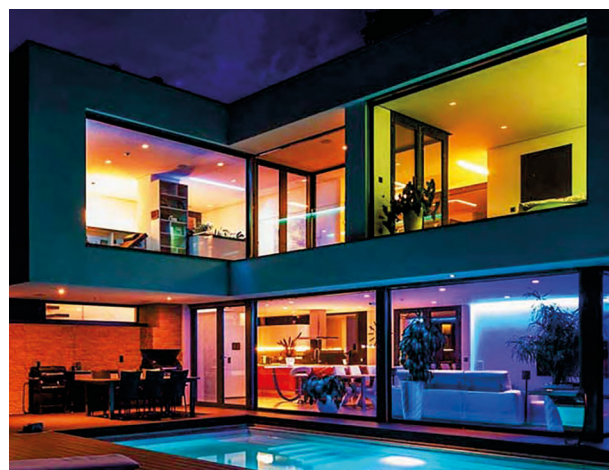

obj. kód	typ	W	lm	rozmer (mm)
1518710	SAGA GU10-6W RGBW WIFI	6	450	D50x56



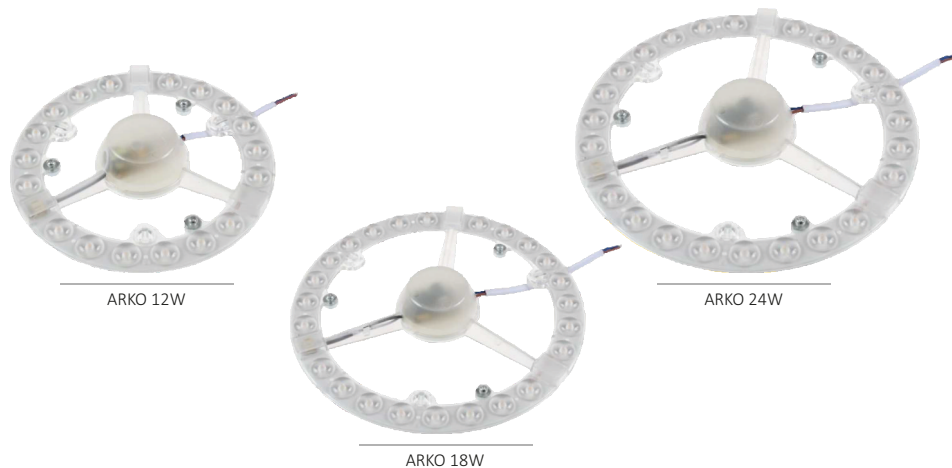

ARKO 12W

ARKO 24W

ARKO 18W

## ARKO

materiál:  
kov, plast

IP 20

220-240 V

50/60 Hz



30000 h

Ra > 80

obj. kód	typ	W	lm	farba svetla	rozmer (mm)
10806123	ARKO KM1237-12W 3000K	12	1200	teplá	D143x20
10806124	ARKO KM1237-12W 4000K	12	1200	neutrálna	D143x20
10806184	ARKO KM1237-18W 4000K	18	1850	neutrálna	D185x20
10806243	ARKO KM1237-24W 3000K	24	2450	teplá	D228x20
10806244	ARKO KM1237-24W 4000K	24	2450	neutrálna	D228x20



RING 18W

## RING

materiál: plast

IP 20

220-240 V

50/60 Hz



30000 h

Ra > 80

obj. kód	typ	W	lm	farba svetla	rozmer (mm)
10807183	RING KM1031-18W 3000K	18	1800	teplá	D220x25





## Svetelné zdroje LED



T8 TUBELED

LED trubica s jednostranným napájaním.

### T8 TUBELED

materiál: sklo

T8

100-260 V



25000 h

Ra > 80

obj. kód	typ	W	lm	rozmer (mm)	farba svetla
1600310	TUBELED T8-10W 4000K	10	750	D28x600	neutrálina
1600320	TUBELED T8-10W 6500K	10	775	D28x600	studená
1600800	TUBELED T8-14W 6500K	14	1456	D28x900	studená
1600340	TUBELED T8-20W 4000K	20	1850	D28x1200	neutrálina
1600350	TUBELED T8-20W 6500K	20	1900	D28x1200	studená
1600370	TUBELED T8-24W 4000K	24	2280	D28x1500	neutrálina
1600380	TUBELED T8-24W 6500K	24	2340	D28x1500	studená



INSERT LED 5W

### INSERT LED

materiál: plast

LED

230 V



10000 h

Ra > 80

obj. kód	typ	W	lm	rozmer (mm)	farba svetla
10807300	INSERT LED 5W 3000K	5	450	D50x24	teplá
10807301	INSERT LED 5W 4000K	5	450	D50x24	neutrálina
10807302	INSERT LED 5W 6000K	5	450	D50x24	studená



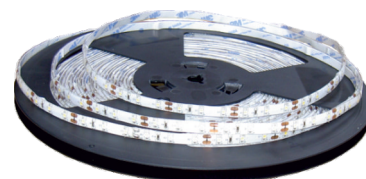
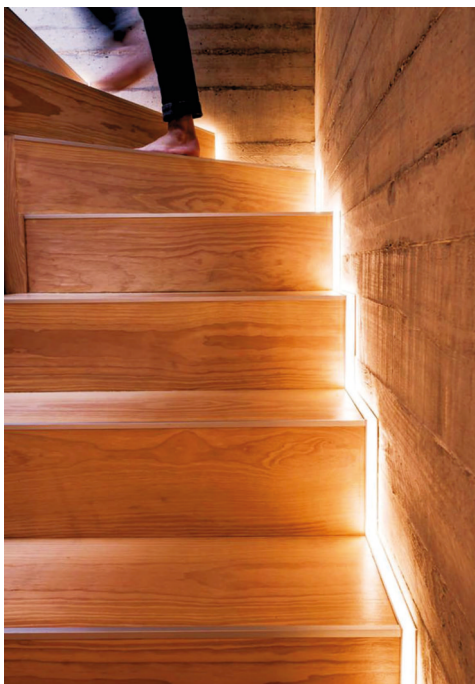

4,8W-M IP20



**4,8 W/m**

led/m: 60  
lm/led: 7-9 lm  
Modul: 5 cm  
Rozmer: 8x2,5 mm

IP 20

12 V DC

3528 SMD

Ra>90



obj. kód	typ	farba svetla
21248203	4,8W-M 3000K IP20	teplá
21248204	4,8W-M 4000K IP20	neutrálna
21248206	4,8W-M 6000K IP20	studená

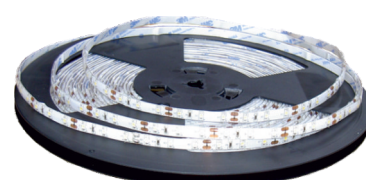

4,8W-M IP65



**4,8 W/m**

led/m: 60  
lm/led: 7-9 lm  
Modul: 5 cm  
Rozmer: 8x3 mm

IP 65

12 V DC

3528 SMD

Ra>90



obj. kód	typ	farba svetla
21248653	4,8W-M 3000K IP65	teplá
21248654	4,8W-M 4000K IP65	neutrálna
21248656	4,8W-M 6000K IP65	studená
21248651	4,8W-M RED IP65	červená
21248652	4,8W-M GREEN IP65	zelená
21248658	4,8W-M BLUE IP65	modrá
21248657	4,8W-M YELLOW IP65	žltá



# LED pásy 12V



6W-M IP20



## 6 W/m

led/m: 30  
lm/led: 22 lm  
Modul: 10 cm  
Rozmer: 10x2,5 mm

IP 20

12 V DC

2835 SMD

Ra>94



obj. kód	Typ	farba svetla
21206203	6W-M 3000K IP20	teplá
21206204	6W-M 4000K IP20	neutrálna
21206206	6W-M 6000K IP20	studená



6W-M IP65



## 6 W/m

led/m: 30  
lm/led: 22 lm  
Modul: 10 cm  
Rozmer: 10x3 mm

IP 65

12 V DC

2835 SMD

Ra>94



obj. kód	Typ	farba svetla
21206653	6W-M 3000K IP65	teplá
21206654	6W-M 4000K IP65	neutrálna
21206656	6W-M 6000K IP65	studená

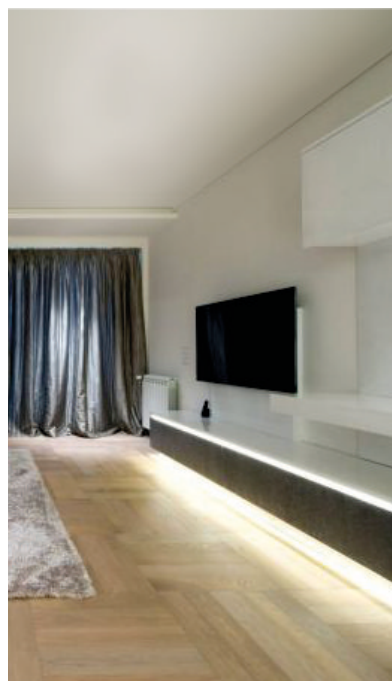

# LED pásy 12V



9,6W-M IP20



**9,6 W/m**  
led/m: 120  
lm/led: 7-9 lm  
Modul: 2,5 cm  
Rozmer: 8x2,5 mm

- IP 20
- 12 V DC
- 3528 SMD
- Ra>90



obj. kód	Typ	farba svetla
21296203	9,6W-M 3000K IP20 12V	teplá
21296204	9,6W-M 4000K IP20 12V	neutrálna
21296206	9,6W-M 6000K IP20 12V	studená

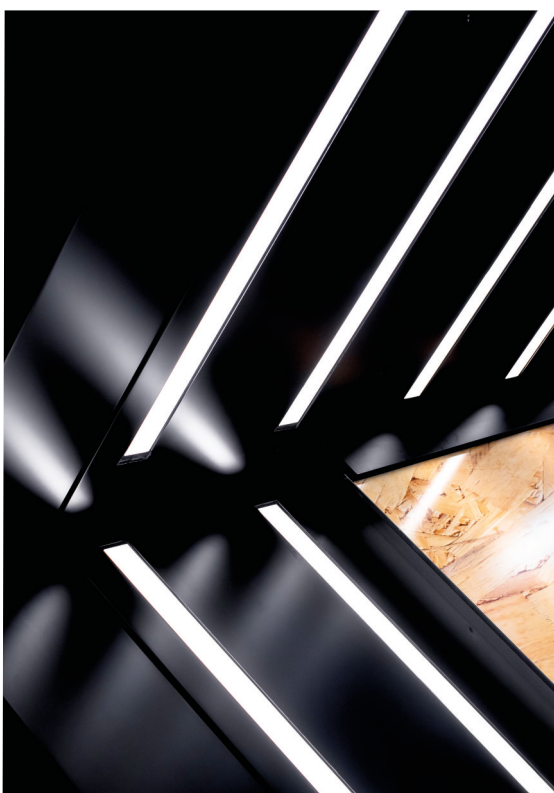

9,6W-M IP65



**9,6 W/m**  
led/m: 120  
lm/led: 7-9 lm  
Modul: 2,5 cm  
Rozmer: 8x3 mm

- IP 65
- 12 V DC
- 3528 SMD
- Ra>90



obj. kód	Typ	farba svetla
21296653	9,6W-M 3000K IP65 12V	teplá
21296654	9,6W-M 4000K IP65 12V	neutrálna
21296656	9,6W-M 6000K IP65 12V	studená



# LED pásy 12V



12,5W-M IP20



## 12,5 W/m

led/m: 60  
lm/led: 22 lm  
Modul: 5 cm  
Rozmer: 10x2,5 mm

IP 20

12 V DC

2835 SMD



Ra>94



obj. kód	typ	farba svetla
21212203	12,5W-M 3000K IP20	teplá
21212204	12,5W-M 4000K IP20	neutrálna
21212206	12,5W-M 6000K IP20	studená



12,5W-M IP65



## 12,5 W/m

led/m: 60  
lm/led: 22 lm  
Modul: 5 cm  
Rozmer: 10x3 mm

IP 65

12 V DC

2835 SMD



Ra>94



obj. kód	typ	farba svetla
21212653	12,5W-M 3000K IP65	teplá
21212654	12,5W-M 4000K IP65	neutrálna
21212656	12,5W-M 6000K IP65	studená



17,2W-M IP20



## 17,2 W/m

led/m: 72  
lm/led: 20-22 lm  
Modul: 1,39 cm  
Rozmer: 10x2,5 mm

IP 20

12 V DC

5050 SMD



Ra>90



obj. kód	typ	farba svetla
21217203	17,2W-M 3000K IP20 12V	teplá
21217204	17,2W-M 4000K IP20 12V	neutrálna
21217206	17,2W-M 6000K IP20 12V	studená



4,8W-M RGB IP20 12V



## RGB

## 4,8 W/m

led/m: 60  
lm/led: 9 lm  
Modul: 5 cm  
Rozmer: 10x2,5 mm

IP 20

12 V DC

5050 SMD



obj. kód	typ	farba svetla
21248200	4,8W-M RGB IP20 12V	RGB



7,2W-M RGB IP20



## RGB 7,2 W/m

led/m: 30  
lm/led: 20 lm  
Modul: 10 cm  
Rozmer: 10x2,5 mm

IP 20

12 V DC

5050 SMD



obj. kód	typ	farba svetla
21272200	7,2W-M RGB IP20	RGB



7,2W-M RGB IP65



## RGB 7,2 W/m

led/m: 30  
lm/led: 20 lm  
Modul: 10 cm  
Rozmer: 10x3 mm

IP 65

12 V DC

5050 SMD



obj. kód	typ	farba svetla
21272650	7,2W-M RGB IP65	RGB



14,4W-M RGB IP20

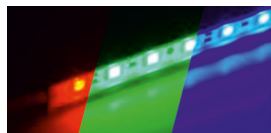

## RGB 14,4 W/m

led/m: 60  
lm/led: 20 lm  
Modul: 5 cm  
Rozmer: 10x2,5 mm

IP 20

12 V DC

5050 SMD



obj. kód	typ	farba svetla
21214200	14,4W-M RGB IP20	RGB



14,4W-M RGB IP65



## RGB 14,4 W/m

led/m: 60  
lm/led: 20 lm  
Modul: 5 cm  
Rozmer: 10x3 mm

IP 65

12 V DC

5050 SMD



obj. kód	typ	farba svetla
21214650	14,4W-M RGB IP65	RGB



# LED pásy 12V



## RGB + WW

14,4 W/m  
led/m: 60  
lm/led: 22 lm  
Modul: 10 cm  
Rozmer: 10x2,5 mm



14,4W-M RGB+WW IP20 12V



IP 20

12 V DC

5050 SMD

Ra>90



obj. kód	typ	farba svetla
21214208	14,4W-M RGB+WW IP20 12V	RGB + WW



## RGB + NW

14,4 W/m  
led/m: 60  
lm/led: 22 lm  
Modul: 10 cm  
Rozmer: 10x2,5 mm



14,4W-M RGB+NW IP20 12V

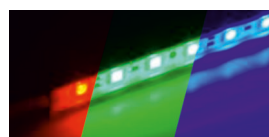

IP 20

12 V DC

5050 SMD

Ra>90



obj. kód	typ	farba svetla
21214207	14,4W-M RGB+NW IP20 12V	RGB + NW



## RGB + CW

14,4 W/m  
led/m: 60  
lm/led: 20-22 lm  
Modul: 10 cm  
Rozmer: 10x2,5 mm



14,4W-M RGB+CW IP20 12V



IP 20

12 V DC

5050 SMD

Ra>90



obj. kód	typ	farba svetla
21214201	14,4W-M RGB+CW IP20 12V	RGB + CW



## WW + CW

14,4 W/m  
led/m: 60  
lm/led: 22 lm  
Modul: 10 cm  
Rozmer: 10x2,5 mm



14,4W-M WW+CW IP20 12V



IP 20

12 V DC

5050 SMD

Ra>90



obj. kód	typ	farba svetla
21214205	14,4W-M WW+CW IP20 12V	teplá + studená

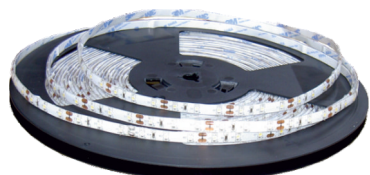

4,8W-M IP20 24V



## 4,8 W/m

led/m: 60  
lm/led: 7-9 lm  
Modul: 10 cm  
Rozmer: 8x2,5 mm

IP 20

24 V DC

3528 SMD

Ra>90



obj. kód	typ	farba svetla
22448203	4,8W-M 3000K IP20 24V	teplá
22448204	4,8W-M 4000K IP20 24V	neutrálna
22448206	4,8W-M 6000K IP20 24V	studená

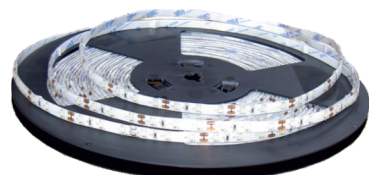

4,8W-M IP65 24V



## 4,8 W/m

led/m: 60  
lm/led: 7-9 lm  
Modul: 10 cm  
Rozmer: 8x3 mm

IP 65

24 V DC

3528 SMD

Ra>90



obj. kód	typ	farba svetla
22448653	4,8W-M 3000K IP65 24V	teplá
22448654	4,8W-M 4000K IP65 24V	neutrálna
22448656	4,8W-M 6000K IP65 24V	studená



6W-M IP20 24V



## 6 W/m

led/m: 30  
lm/led: 22 lm  
Modul: 16,5 cm  
Rozmer: 10x2,5 mm

IP 20

24 V DC

2835 SMD

Ra>94



obj. kód	typ	farba svetla
22406203	6W-M 3000K IP20 24V	teplá
22406204	6W-M 4000K IP20 24V	neutrálna
22406206	6W-M 6000K IP20 24V	studená

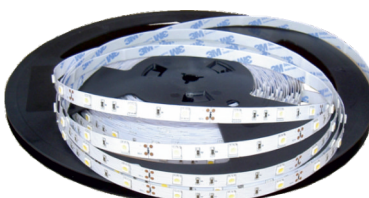

6W-M IP65 24V



## 6 W/m

led/m: 30  
lm/led: 22 lm  
Modul: 16,5 cm  
Rozmer: 10x3 mm

IP 65

24 V DC

2835 SMD

Ra>94



obj. kód	typ	farba svetla
22406653	6W-M 3000K IP65 24V	teplá
22406654	6W-M 4000K IP65 24V	neutrálna
22406656	6W-M 6000K IP65 24V	studená





# LED pásy 24V



7,2W-M IP20 24V

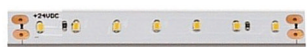

## 7,2 W/m

led/m: 112  
lm/led: 6 lm  
Modul: 6,25 cm  
Rozmer: 8x2,5 mm

IP 20

24 V DC

2216 SMD



obj. kód	typ	farba svetla
22472203	7,2W-M 3000K IP20 24V	teplá
22472204	7,2W-M 4000K IP20 24V	neutrálna
22472206	7,2W-M 6000K IP20 24V	studená



9,6W-M IP20 24V



## 9,6 W/m

led/m: 120  
lm/led: 7-9 lm  
Modul: 2,5 cm  
Rozmer: 8x2,5 mm

IP 20

24 V DC

3528 SMD



obj. kód	typ	farba svetla
22496203	9,6W-M 3000K IP20 24V	teplá
22496204	9,6W-M 4000K IP20 24V	neutrálna
22496206	9,6W-M 6000K IP20 24V	studená



9,6W-M IP65 24V



## 9,6 W/m

led/m: 120  
lm/led: 7-9 lm  
Modul: 2,5 cm  
Rozmer: 8x3 mm

IP 65

24 V DC

3528 SMD

Ra>90



obj. kód	typ	farba svetla
22496653	9,6W-M 3000K IP65 24V	teplá
22496654	9,6W-M 4000K IP65 24V	neutrálna
22496656	9,6W-M 6000K IP65 24V	studená



12,5W-M IP20 24V



## 12,5 W/m

led/m: 60  
lm/led: 22 lm  
Modul: 10 cm  
Rozmer:  
10x2,5 mm

IP 20

24 V DC

2835 SMD

Ra>94



obj. kód	typ	farba svetla
22412203	12,5W-M 3000K IP20 24V	teplá
22412204	12,5W-M 4000K IP20 24V	neutrálna
22412206	12,5W-M 6000K IP20 24V	studená



12,5W-M IP65 24V



## 12,5 W/m

led/m: 60  
lm/led: 22 lm  
Modul: 10 cm  
Rozmer:  
10x3 mm

IP 65

24 V DC

2835 SMD

Ra>94



obj. kód	typ	farba svetla
22412653	12,5W-M 3000K IP65 24V	teplá
22412654	12,5W-M 4000K IP65 24V	neutrálna
22412656	12,5W-M 6000K IP65 24V	studená



19,2W-M IP20 24V



## 19,2 W/m

led/m: 240  
lm/led: 7-9 lm  
Modul: 2,5 cm  
Rozmer:  
10x2,5 mm

IP 20

24 V DC

3528SMD

Ra>90



obj. kód	typ	farba svetla
22419203	19,2W-M 3000K IP20 24V	teplá
22419204	19,2W-M 4000K IP20 24V	neutrálna
22419206	19,2W-M 6000K IP20 24V	studená



22W-M IP20



## 22 W/m

led/m: 60  
lm/led: 45 lm  
Modul: 10 cm  
Rozmer:  
10x2,5 mm

IP 20

24 V DC

5630SMD

Ra>90



obj. kód	typ	farba svetla
22422203	22W-M 3000K IP20	teplá
22422204	22W-M 4000K IP20	neutrálna
22422206	22W-M 6000K IP20	studená



# LED pásy 24V



4,8W-M RGB IP20 24V



## RGB 4,8 W/m

led/m: 60  
lm/led: 9 lm  
Modul: 10 cm  
Rozmer: 10x2,5

IP 20

24 V DC

5050 SMD



obj. kód	typ	farba svetla
22448200	4,8W-M RGB IP20 24V	RGB

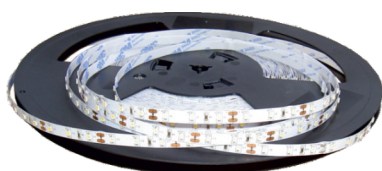

7,2W-M RGB IP20 24V



## RGB 7,2 W/m

led/m: 30  
lm/led: 20 lm  
Modul: 16,5 cm  
Rozmer: 10x3

IP 20

24 V DC

5050SMD



obj. kód	typ	farba svetla
22472200	7,2W-M RGB IP20 24V	RGB



7,2W-M RGB IP65 24V

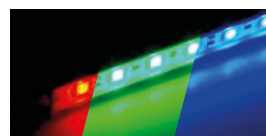

## RGB 7,2 W/m

led/m: 30  
lm/led: 20 lm  
Modul: 16,5 cm  
Rozmer: 10x3

IP 65

24 V DC

5050SMD



obj. kód	typ	farba svetla
22472650	7,2W-M RGB IP65 24V	RGB



14,4W-M RGB IP65 24V



**RGB**  
14,4 W/m  
led/m: 60  
lm/led: 20 lm  
Modul: 10 cm  
Rozmer: 10x3 mm

IP 65

24 V DC

5050SMD



obj. kód	typ	farba svetla
22414650	14,4W-M RGB IP65 24V	RGB



14,4W-M RGB IP20 24V

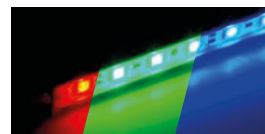

**RGB**  
14,4 W/m  
led/m: 60  
lm/led: 20 lm  
Modul: 10 cm  
Rozmer: 10x2,5 mm

IP 20

24 V DC

5050SMD



obj. kód	typ	farba svetla
22414200	14,4W-M RGB IP20 24V	RGB



14,4W-M RGB+WW IP20 24V

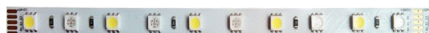

**RGB + WW**  
14,4 W/m  
led/m: 60  
lm/led: 22 lm  
Modul: 16,5 cm  
Rozmer: 10x2,5 mm

IP 20

24 V DC

5050 SMD

Ra>90



obj. kód	typ	farba svetla
22414208	14,4W-M RGB+WW IP20 24V	RGB + WW



14,4W-M RGB+NW IP20 24V

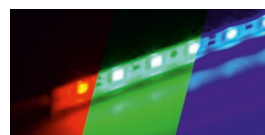
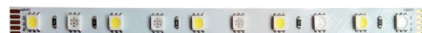

**RGB + NW**  
14,4 W/m  
led/m: 60  
lm/led: 22 lm  
Modul: 16,5 cm  
Rozmer: 10x2,5 mm

IP 20

24 V DC

5050 SMD

Ra>90



obj. kód	typ	farba svetla
22414207	14,4W-M RGB+NW IP20 24V	RGB + NW



# LED pásy 24V



**RGB  
+  
CW**  
14,4 W/m

led/m: 60  
lm/led: 20-22 lm  
Modul: 16,5 cm  
Rozmer:  
10x2,5 mm



14,4W-M RGB+CW IP20 24V



IP 20

24 V DC

5050 SMD

Ra>90



obj. kód	typ	farba svetla
22414201	14,4W-M RGB+CW IP20 24V	RGB + studená



**WW  
+  
CW**  
14,4 W/m

led/m: 60  
lm/led: 22 lm  
Modul: 16,67 cm  
Rozmer:  
10x2,5 mm



14,4W-M WW+CW IP20 24V



IP 20

24 V DC

5050 SMD

Ra>90



obj. kód	typ	farba svetla
22414205	14,4W-M WW+CW IP20 24V	teplá + studená

**RGB  
+  
WW  
+  
CW**  
23 W/m

led/m: 288  
lm/m: 1100  
Modul: 6,25 cm  
Rozmer:  
12x2,5 mm



23W-M RGB+WW+CW Ip20 24V

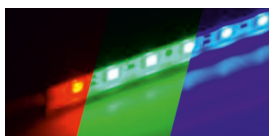

IP 20

24 V DC

3535 SMD  
+2216 SMD

Ra>90



obj. kód	typ	farba svetla
22423202	23W-M RGB+WW+CW Ip20 24V	RGB + teplá + studená





7,6W-M IP20 48V

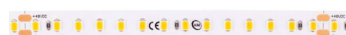

## 7,6 W-M

W/m: 7,6  
led/m: 120  
lm/m: 900  
Modul: 12,5 cm  
Rozmer: 10x2,5 mm

IP 20

48 V DC

2835 SMD

50000 h



Ra>90



obj. kód	typ	farba svetla
24876203	7,6W-M 3000K IP20 48V	teplá
24876204	7,6W-M 4000K IP20 48V	neutrálna
24876206	7,6W-M 6500K IP20 48V	studená



10W-M IP20 48V



## 10 W-M

W/m: 10  
led/m: 140  
lm/m: 1100  
Modul: 10 cm  
Rozmer: 10x2,5 mm

IP 20

48 V DC

2835 SMD

50000 h



Ra>97



obj. kód	typ	farba svetla
24810203	10W-M 3000K IP20 48V	teplá
24810204	10W-M 4000K IP20 48V	neutrálna
24810206	10W-M 6500K IP20 48V	studená



## LED pásy 48V



### 16,8 W-M

W/m: 16,8  
led/m: 120  
lm/m: 1930  
Modul: 12,5 cm  
Rozmer: 10x2,5 mm



16,8W-M IP20 48V



IP 20

48 V DC

2835 SMD

50000 h



Ra>97

obj. kód	typ	farba svetla
24816203	16,8W-M 3000K IP20 48V	teplá
24816204	16,8W-M 4000K IP20 48V	neutrálna
24816206	16,8W-M 6500K IP20 48V	studená



### RGB 10 W-M

W/m: 10  
led/m: 140  
lm/m: 530  
Modul: 10 cm  
Rozmer: 10x2,5 mm



10W-M RGB IP20 48V



IP 20

48 V DC

3535 SMD

50000 h



Ra>97

obj. kód	typ	farba svetla
24810200	10W-M RGB IP20 48V	RGB





4,8W-M S-TYP IP20 12V



## S-TYP 4,8 W/m

led/m: 60  
Modul: 5 cm  
Rozmer: 6x2,5 mm

IP 20

12 V DC

3528 SMD

Ra>90



obj. kód	typ	lm/m	f. svetla
21248213	4,8W-M S-TYP 3000K IP20 12V	385	teplá
21248214	4,8W-M S-TYP 4000K IP20 12V	420	neutrálna
21248216	4,8W-M S-TYP 6500K IP20 12V	400	studená



4,8W-M S-TYP IP20 24V



## S-TYP 4,8 W/m

led/m: 60  
Modul: 10 cm  
Rozmer: 6x2,5 mm

IP 20

24 V DC

3528 SMD

Ra>90



obj. kód	typ	lm/m	f. svetla
22448213	4,8W-M S-TYP 3000K IP20 24V	385	teplá
22448214	4,8W-M S-TYP 4000K IP20 24V	420	neutrálna
22448216	4,8W-M S-TYP 6500K IP20 24V	400	studená





## LED pásy S-tyt



12W-M S-TYP IP20 12V



### S-TYP 12 W/m

led/m: 60  
Modul: 5 cm  
Rozmer: 6x2,5 mm

IP 20

12 V DC

2835 SMD

Ra>97



obj. kód	typ	lm/m	f. svetla
21212213	4,8W-M S-TYP 3000K IP20 12V	972	teplá
21212214	4,8W-M S-TYP 4000K IP20 12V	996	neutrálna
21212216	4,8W-M S-TYP 6500K IP20 12V	996	studená



12W-M S-TYP IP20 24V



### S-TYP 12 W/m

led/m: 60  
Modul: 10 cm  
Rozmer: 6x2,5 mm

IP 20

24 V DC

2835 SMD

Ra>97



obj. kód	typ	lm/m	f. svetla
22412213	12W-M S-TYP 3000K IP20 24V	972	teplá
22412214	12W-M S-TYP 4000K IP20 24V	996	neutrálna
22412216	12W-M S-TYP 6500K IP20 24V	996	studená

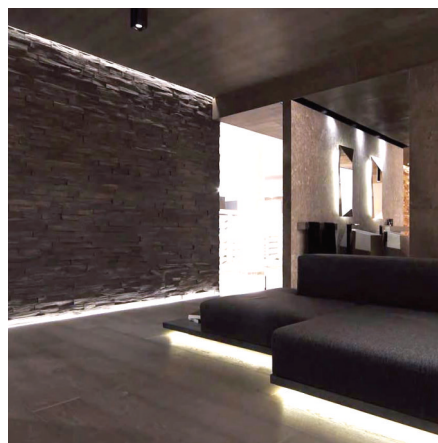

# LED pásy S-Typ



Možnosť  
odstrihnutia  
na mieru

15 m  
kotúč

Záruka  
5  
rokov



4,8W-M S-TYP RGB IP20 24V

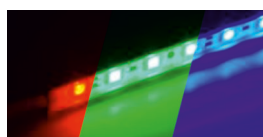

**S-TYP**  
**RGB**  
**4,8 W/m**

led/m: 60  
lm/m: 540  
Modul: 10 cm  
Rozmer:  
8x2,5 mm

IP 20

24 V DC

3535 SMD

Ra>90



obj. kód	typ	farba svetla
22448210	4,8W-M S-TYP RGB IP20 24V	RGB



Možnosť  
odstrihnutia  
na mieru

15 m  
kotúč

Záruka  
5  
rokov



14,4W-M S-TYP RGB IP20 24V



**S-TYP**  
**RGB**  
**14,4 W/m**

led/m: 60  
lm/m: 540  
Modul: 10 cm  
Rozmer:  
8x2,5 mm

IP 20

24 V DC

3535 SMD

Ra>90



obj. kód	typ	farba svetla
22414210	14,4W-M S-TYP RGB IP20 24V	RGB



# LED pásy COB



8W-M IP20 24V COB

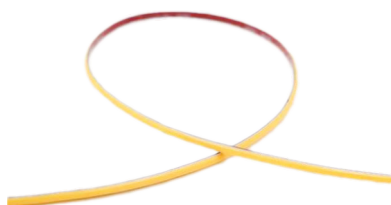

## 8 W/m COB

led/m: 1  
Modul: 5 cm  
Rozmer: 4x2 mm

IP 20

24 V DC

Ra>90



obj. kód	typ	lm/m	f. svetla
22408203	8W-M 3000K IP20 24V COB	700	teplá
22408204	8W-M 4000K IP20 24V COB	776	neutrálna
22408206	8W-M 6500K IP20 24V COB	800	studená



10W-M IP20 12V COB



## 10 W/m COB

led/m: 1  
lm/led: 910 lm  
Modul: 5 cm  
Rozmer: 10x2,5 mm

IP 20

12 V DC

COB

Ra>90



obj. kód	typ	farba svetla
21210203	10W-M 3000K IP20 12V COB	teplá
21210204	10W-M 4000K IP20 12V COB	neutrálna
21210206	10W-M 6000K IP20 12V COB	studená



10W-M IP20 24V COB



## 10 W/m COB

led/m: 1  
lm/led: 910 lm  
Modul: 5 cm  
Rozmer: 8x2,5 mm

IP 20

24 V DC

COB

Ra>90



obj. kód	typ	farba svetla
22410203	10W-M 3000K IP20 24V COB	teplá
22410204	10W-M 4000K IP20 24V COB	neutrálna
22410206	10W-M 6000K IP20 24V COB	studená



15W-M IP20 24V COB



## 15 W/m COB

led/m: 1  
Modul: 5 cm  
Rozmer: 10x2 mm

IP 20

24 V DC

Ra>90



obj. kód	typ	lm/m	f. svetla
22415203	15W-M 3000K IP20 24V COB	1354	teplá
22415204	15W-M 4000K IP20 24V COB	1428	neutrálna
22415206	15W-M 6500K IP20 24V COB	1446	studená

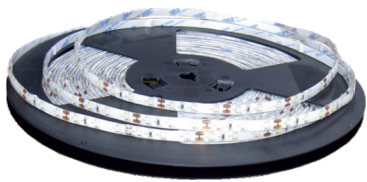

15W-M RGB IP20 24V COB



## RGB 15 W/m COB

LED/m: 1  
lm/LED: 1354  
Modul: 5 cm  
Rozmer: 12x1,7 mm

IP 20

24 V DC

Ra>90



obj. kód	typ	farba svetla
22415200	15W-M RGB IP20 24V COB	RGB





## Príslušenstvo LED



Vypínač 250V, 6A, čierny  
Obj. kód: 20323061



Vypínač 250V, 6A biely  
Obj. kód: 20323060



Vypínač medzišnúrový  
KM-VM-01 čierny  
Obj. kód: 20323080



Vypínač dotykový nestmievateľný  
KM-VD-02L, 12V-96W, 24V-192W  
Obj. kód: 20312145

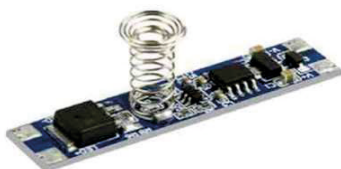

Vypínač dotykový stmievateľný  
KM-VDS-03L, 12V-96W, 24V-192W  
Obj. kód: 20312146



Vypínač bezdotykový nestmievateľný  
KM-VB-02L, 12V-96W, 24V-192W  
Obj. kód: 20312155



Vypínač bezdotykový stmievateľný  
KM-VBS-03L, 12V-96W, 24V-192W  
Obj. kód: 20312156



Vypínač dotykový  
KM-VDS-01L, 60W 12V  
Obj. kód: 20312140



Vypínač dotykový KM-VD-02Z, 60W 12V  
Obj. kód: 20312142



Vypínač dotykový stmievateľný  
KM-VDS-03Z, 48W 12V  
Obj. kód: 20312143

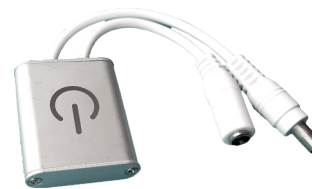

Vypínač dotykový stmievateľný  
KM-VDS-04P, 12V-72W, 24V-144W  
Obj. kód: 20312144



Vypínač bezdotykový  
KM-VB-01L, 12V-24W, 24V-48W  
Obj. kód: 20312150



Vypínač bezdotykový  
KM-VB-02P, 12V-60W, 24V-100W  
Obj. kód: 20312152



Senzor dverí  
KM-VB-03P, 12V-60W, 24V-100W  
Obj. kód: 20312153



Senzor IR do lišty  
KM-IRS-01L, 12V-96W, 24V-192W  
Obj. kód: 20312160



Senzor IR na zapustenie  
KM-IRS-03Z, 12V-24W, 24V-48W  
Obj. kód: 20312163



Senzor IR na povrch  
KM-IRS-02P, 12V-24W, 24V-48W  
Obj. kód: 20312162



Konektor 2.1, 5.5  
Obj. kód: 20000005

Konektor 2.1, 5.5 Y  
Obj. kód: 20000006

Konektor 2.1-5.5 Y 40CM  
Obj. kód: 20000007



Konektor 8mm  
Obj. kód: 20000008



Konektor 10mm  
Obj. kód: 20000010



Konektor RGB  
Obj. kód: 20000012



Konektor RGBW 5P  
Obj. kód: 20000013



Konektor 2PIN  
Obj. kód: 20000001



Konektor 2PIN Y  
Obj. kód: 20000002



Konektor 4PIN  
Obj. kód: 20000003



Konektor 4PIN Y  
Obj. kód: 20000004



Konektor prepojovací 8mm  
Obj. kód: 20000108



Konektor prepojovací 10mm  
Obj. kód: 20000110



Konektor prepojovací RGB  
Obj. kód: 20000112



Konektor prepojovací RGBW  
Obj. kód: 20000113



4PIN BL  
Obj. kód: 20000120



Kábel 2x0,35  
Obj. kód: 70102035



Kábel RGB  
Obj. kód: 70104035



Kábel RGBW  
Obj. kód: 70104036



Kábel RGB+WW+CW  
Obj. kód: 70104037



Konektor SVORKA 2.1-5.5  
Obj. kód: 20000020



Konektor SVORKA 2.1-5.5 Y  
Obj. kód: 20000021



Konektor SVORKA 2.1-5.5 B  
Obj. kód: 20000022



Konektor SVORKA 2.1-5.5 Y B  
Obj. kód: 20000023



Spojka 8mm  
Obj. kód: 20000208



Spojka 10mm  
Obj. kód: 20000210



Spojka RGB  
Obj. kód: 20000212



Spojka RGBW 5PIN  
Obj. kód: 20000213



Spojka rohová 8 mm  
Obj. kód: 20000218



Spojka rohová 10 mm  
Obj. kód: 20000219



Spojka rohová RGB  
Obj. kód: 20000220



Spojka rohová RGBW  
Obj. kód: 20000221



Spojka 8MM ROHOVÁ PCB  
Obj. kód: 20000228

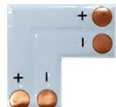

Spojka 10MM ROHOVÁ PCB  
Obj. kód: 20000229

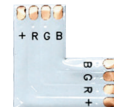

Spojka RGB ROHOVÁ PCB  
Obj. kód: 20000230



Spojka RGBV ROHOVÁ PCB  
Obj. kód: 20000231



Konektor 8MM- 2.1-5.5 Y  
Obj. kód: 20000115



Konektor 10MM- 2.1-5.5 Y  
Obj. kód: 20000116



Konektor rozbočovací 2.1, 5.5 2X  
Obj. kód: 20000014



Konektor rozbočovací 2.1, 5.5 3X  
Obj. kód: 20000015



# Príslušenstvo LED

## Konektor KM-10-A

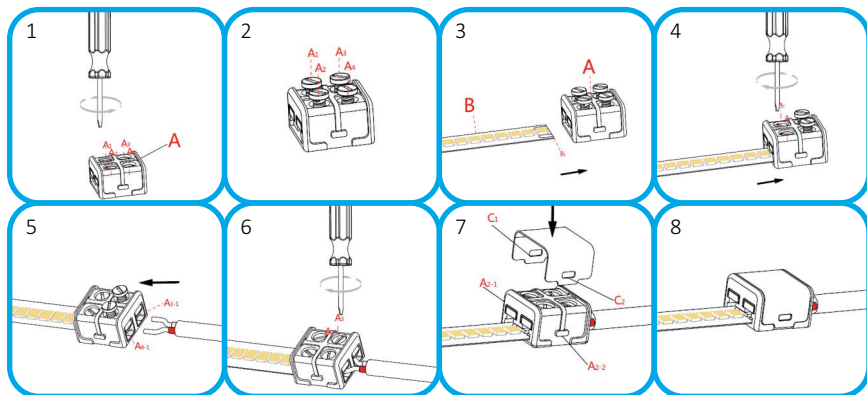

Konektor KM-10A  
Obj. kód: 20000030



Spojka KM-10A-2P 8-10mm  
Obj. kód: 20000216



Spojka rohová KM-10A-2P L 8-10 mm  
Obj. kód: 20000217

## Spojka KM-10-A 2P

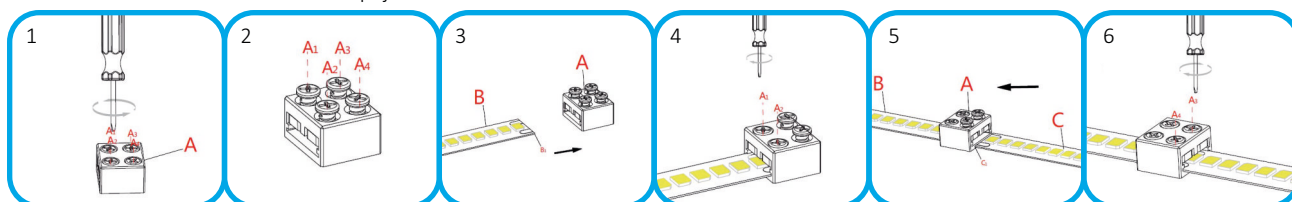

## Spojka KM-10-A 2P L

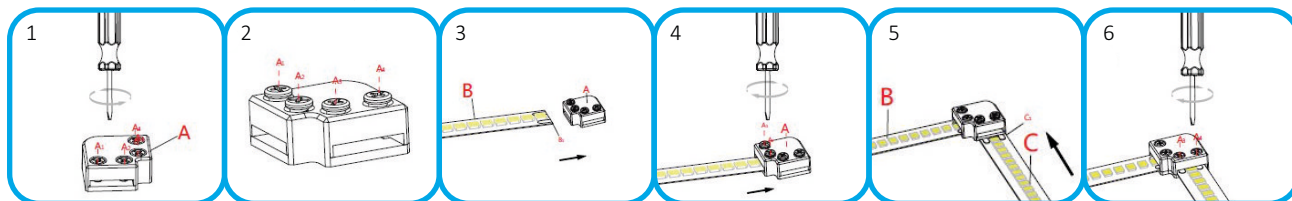

Konektor 8MM COB  
Obj. kód: 20000009



Konektor 10MM COB  
Obj. kód: 20000011



Konektor prepojavací 8MM COB  
Obj. kód: 20000109



Konektor prepojavací 10MM COB  
Obj. kód: 20000111



Konektor 5PIN BL  
Obj. kód: 20000121



Spojka 8MM COB  
Obj. kód: 20000209



Spojka 10MM COB  
Obj. kód: 20000211

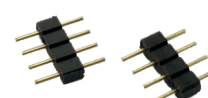

Spojka 4PIN 2H  
Obj. kód: 20000236



KM-2P-D  
Obj. kód: 73000020



KM-2P-D-02  
Obj. kód: 73000030



KM-3P-D-02  
Obj. kód: 73000031



KM-2PX2-D-02  
Obj. kód: 73000040



KM-3PX2-D-02  
Obj. kód: 73000041



KM-3PX3-D-02  
Obj. kód: 73000042



KM-2D-V-01  
Obj. kód: 73000050



KM-3D-V-01  
Obj. kód: 73000053



KM-5D-V-01  
Obj. kód: 73000055



KM-2D-V-02  
Obj. kód: 73000060



KM-3D-V-02  
Obj. kód: 73000063



KM-4D-V-02  
Obj. kód: 73000064



KM-5D-V-02  
Obj. kód: 73000065



TB2-24S2O 2X2,5MM2  
Obj. kód 7200060



TB2-24S3G 3X2,5MM2  
Obj. kód 7200070



TB2-24S5Y 5X2,5MM2  
Obj. kód 7200080



TB2-24D5G 2X2X2,5MM2  
Obj. kód 7200090

obj. kód	typ	priemer vodiča	V	typ vodiča, monáž
73000020	KM-2P-D bezskrutková	0,5-2,5 mm <sup>2</sup>	230	tvrdý/mäkký, nasunutím a zacvaknutím
73000030	KM-2P-D-02 bezskrutková	0,5-2,5 mm <sup>2</sup>	230	tvrdý/mäkký, nasunutím a zacvaknutím
73000031	KM-3P-D-02 bezskrutková	0,5-2,5 mm <sup>2</sup>	230	tvrdý/mäkký, nasunutím a zacvaknutím
73000040	KM-2PX2-D-02 bezskrutková	0,5-2,5 mm <sup>2</sup>	230	tvrdý/mäkký, nasunutím a zacvaknutím
73000041	KM-3PX2-D-02 bezskrutková	0,5-2,5 mm <sup>2</sup>	230	tvrdý/mäkký, nasunutím a zacvaknutím
73000042	KM-3PX3-D-02 bezskrutková	0,5-2,5 mm <sup>2</sup>	230	tvrdý/mäkký, nasunutím a zacvaknutím
73000050	KM-2D-V-01 bezskrutková	0,5-2,5 mm <sup>2</sup>	230	tvrdý/mäkký, nasunutím a zacvaknutím
73000053	KM-3D-V-01 bezskrutková	0,5-2,5 mm <sup>2</sup>	230	tvrdý/mäkký, nasunutím a zacvaknutím
73000055	KM-5D-V-01 bezskrutková	0,5-2,5 mm <sup>2</sup>	230	tvrdý/mäkký, nasunutím a zacvaknutím
73000060	KM-2D-V-02 bezskrutková	0,14-4 mm <sup>2</sup>	230	tvrdý/mäkký, nasunutím a zacvaknutím
73000063	KM-3D-V-02 bezskrutková	0,14-4 mm <sup>2</sup>	230	tvrdý/mäkký, nasunutím a zacvaknutím
73000064	KM-4D-V-02 bezskrutková	0,14-4 mm <sup>2</sup>	230	tvrdý/mäkký, nasunutím a zacvaknutím
73000065	KM-5D-V-02 bezskrutková	0,14-4 mm <sup>2</sup>	230	tvrdý/mäkký, nasunutím a zacvaknutím
7200060	TB2-24S2O 2X2,5MM2	0,5-2,5 mm <sup>2</sup>	300	tvrdý, nasunutím
7200070	TB2-24S3G 3X2,5MM2	0,5-2,5 mm <sup>2</sup>	300	tvrdý, nasunutím
7200080	TB2-24S5Y 5X2,5MM2	0,5-2,5 mm <sup>2</sup>	300	tvrdý, nasunutím
7200090	TB2-24D5G 2X2X2,5MM2	0,5-2,5 mm <sup>2</sup>	300	tvrdý, nasunutím

## SVORKA

materiál:  
plast, kov

**230 V**  
**300 V**



## Príslušenstvo LED



CLIP 1-5MM  
Obj. kód 7600020



CLIP 2-7MM  
Obj. kód 7600030



CLIP 3-9MM  
Obj. kód 7600040



CLIP 4-10MM  
Obj. kód 7600050



CLIP 5-12MM  
Obj. kód 7600070



CLIP 6-14MM  
Obj. kód 7600090



CLIP 1,5-6MM  
Obj. kód 7600140



CLIP 2,5-8MM  
Obj. kód 7600150

### KÁBLOVÁ PRÍCHYTKA

materiál:  
plast, kov

obj. kód	typ	farba	rozmer (mm)	obj. kód	typ	farba	rozmer (mm)
7600020	CLIP 1-5MM	biela	15x5	7600070	CLIP 5-12MM	biela	27x12
7600030	CLIP 2-7MM	biela	22x7	7600090	CLIP 6-14MM	biela	32x14
7600040	CLIP 3-9MM	biela	22x9	7600140	CLIP 1,5-6MM	biela	22x6
7600050	CLIP 4-10MM	biela	25x10	7600150	CLIP 2,5-8MM	biela	22x8



E27-CP800  
Obj. kód 74270000



E27-CP800 L  
Obj. kód 7320040



GU10-CERAMIC  
Obj. kód 7320090

### PÄTICA

230V

obj. kód	typ	materiál
74270000	E27-CP800	porcelán
7320090	GU10-CERAMIC	keramika
7320040	E27-CP800 L	porcelán



ŠTARTÉR 4-22W  
Obj. kód 74000022



ŠTARTÉR 4-80W  
Obj. kód 74000080

obj. kód	typ
74000022	ŠTARTÉR 4-22W
74000080	ŠTARTÉR 4-80W

**ŠTARTÉR**

materiál: plast

240V



KRABICA D60  
Obj. kód 74560902

**KRABICA**

materiál: plast



ISOLANTE

obj. kód	typ	farba	rozmer (mm)
7500070	ISOLANTE 10MX15MM WHITE	biela	15x10000
7500080	ISOLANTE 10MX15MM BLACK	čierna	15x10000
7500090	ISOLANTE 10MX15MM RED	červená	15x10000
7500100	ISOLANTE 10MX15MM BLUE	modrá	15x10000
7500110	ISOLANTE 20MX19MM WHITE	biela	19x20000
7500120	ISOLANTE 20MX19MM BLACK	čierna	19x20000
7500130	ISOLANTE 20MX19MM RED	červená	19x20000
7500140	ISOLANTE 20MX19MM BLUE	modrá	19x20000
7500150	ISOLANTE 20MX19MM Y-G	žlto-zelená	19x20000

**IZOLAČNÁ PÁSKA**

materiál:  
plast

do 7000 V



# Ovládanie LED pásov

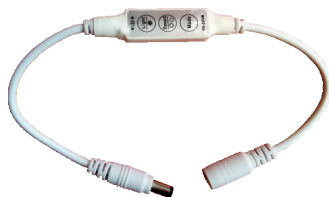

KM-W-01, 72-144W manual  
Obj. kód 38443071



KM-W-02, 72-144W RF  
Obj. kód 38443072



KM-W-05, 96-192 W RF  
Obj. kód 38443096

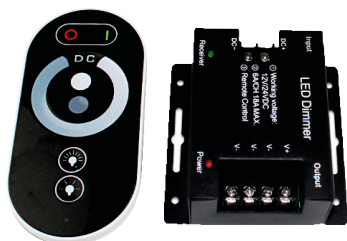

KM-W-11, 216-432W RF  
Obj. kód 38443216



KM-W-06 12V-240W, 24V-480W, RF  
Obj. kód 38443240



KM-W-15, 12-48V DC 30A  
Obj. kód 38443220



KM-W-3Z-20, 144-288 RF  
Obj. kód 38443144



KM-W-4Z-21, 144-288 RF  
Obj. kód 38443145



KM-W-3Z-01 RF  
Obj. kód 38443520



KM-W-4Z-01 RF  
Obj. kód 38443530



## STMIEVAČ

12-24 V DC

12-48 V DC

IP 20



obj. kód	typ	W pri 12/24/48V	I	ovládanie	rozmer (mm)	funkcia
38443071	KM-W-01	72/144/-	6 A	manual	40x12x5	stmievač
38443072	KM-W-02	72/144/-	6 A	RF	40x12x5	stmievač
38443096	KM-W-05	96/192/-	8 A	RF	106x54x34	stmievač
38443240	KM-W-06	240/480/-	20 A	RF	64x53x23	stmievač
38443216	KM-W-11	216/432/-	3x6 A	RF	83x79x33	stmievač
38443220	KM-W-15	360/720/1440	30 A	RF	87x62x20	stmievač
38443144	KM-W-3Z-20	144/288/-	3x4 A	RF	85x45x23	prijímač 3-zónový
38443145	KM-W-4Z-21	144/288/-	3x4 A	RF	85x45x23	prijímač 4-zónový
38443520	KM-W-3Z-01			RF	106x52x4	ovládač 3-zónový
38443530	KM-W-4Z-01				120x52x21	ovládač 4-zónový



KM-WW+CW-3Z-20, 144-288W RF  
Obj. kód 38134144



KM-WW+CW-4Z-21, 144-288W RF  
Obj. kód 38134145



KM-WW+CW-11, 12V-144W, 24V-288W  
Obj. kód 38134535

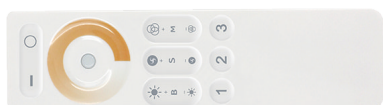

KM-WW+CW-3Z-01 RF  
Obj. kód 38134520



KM-WW+CW-4Z-01 RF  
Obj. kód 38134530

## WW-CW CONTROLLER

12/24 V

IP 20



obj. kód	typ	W	I	ovládanie	rozmer (mm)	funkcia
38134144	KM-WW+CW-3Z-20	144/288	2x6 A	RF	85x45x23	prijímač 3-zónový
38134145	KM-WW+CW-4Z-21	144/288	2x6 A	RF	85x45x23	prijímač 4-zónový
38134520	KM-WW+CW-3Z-01			RF	106x52x4	ovládač 3-zónový
38134530	KM-WW+CW-4Z-01			RF	120x52x21	ovládač 4-zónový
38134535	KM-WW+CW-11	144/288	2x6 A	RF	83x79x33	sada prijímač a ovládač



KM-RGBA-01  
Obj. kód 38754144



KM-RGBA-11  
Obj. kód 38754360

## RGB AMPLIFIER

12/24 V

IP 20



obj. kód	typ	W	I	rozmer (mm)
38754144	KM-RGBA-01	144/288	3x4 A	130x65x25
38754360	KM-RGBA-11	360/720	3x10 A	111x75x26



# Ovládanie LED pásov



KM-RGB-01, 72-144W 24T IR  
Obj. kód 38132072



KM-RGB-02, 72-144W 10T RF  
Obj. kód 38132073



KM-RGB-10, 216-432W RF  
Obj. kód 38133215



KM-RGB-11, 216-432W RF  
Obj. kód 38133216



KM-RGB-13, 360-720W 2,4G RF  
Obj. kód 38133361

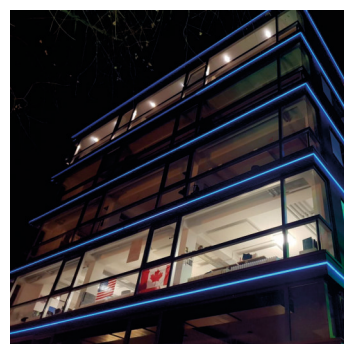

KM-RGB-15 DC 12-48V 36A  
Obj. kód 38133370



KM-RGB-30, 144W-288W KU68  
Obj. kód 38133145



KM-RGB-3Z-20, 144-288W RF  
Obj. kód 38133140



KM-RGB-4Z-21, 144-288W RF  
Obj. kód 38133141



KM-RGB-3Z-01  
Obj. kód 38133501



KM-RGB-4Z-01  
Obj. kód 38133510

## RGB CONTROLLER

12-24 V DC

12-48 V DC

IP 20



obj. kód	typ	W pri 12/24/48V	I	ovládanie	rozmer (mm)	funkcia
38132072	KM-RGB-01	72/144/-	3x2 A	IR	63x35x22	controller
38132073	KM-RGB-02	72/144/-	3x2 A	RF	40x12x5	controller
38133145	KM-RGB-30	144/288/-	3x4 A	manual	86x86x36	controller
38133216	KM-RGB-11	216/432/-	3x6 A	RF	83x79x33	controller
38133361	KM-RGB-13	360/720/-	3x10 A	RF	110x75x24	controller
38133370	KM-RGB-15	432/864/1728	36 A	RF	87x62x20	controller
38133215	KM-RGB-10	216/432/-	3x6 A	RF	85x45x23	controller
38133140	KM-RGB-3Z-20	144/288/-	3x4 A	RF	85x45x23	prijímač 3-zónový
38133141	KM-RGB-4Z-21	144/288/-	3x4 A	RF	85x45x23	prijímač 4-zónový
38133501	KM-RGB-3Z-01			RF	106x52x4	ovládač 3-zónový
38133510	KM-RGB-4Z-01			RF	120x52x21	ovládač 4-zónový

# Ovládanie LED pásov



KM-RGBW-3Z-20, 192-384 W RF  
Obj. kód 38133192



KM-RGBW-4Z-21, 192-384 W RF  
Obj. kód 38133193



KM-RGBW-10, 288-576 W  
Obj. kód 38133289



KM-RGBW-3Z-01  
Obj. kód 38133520



KM-RGBW-4Z-01  
Obj. kód 38133530



## RGB+W CONTROLLER

12/24 V

IP 20



obj. kód	typ	W	I	ovládanie	rozmer (mm)	funkcia
38133289	KM-RGBW-10	288/576	4x6 A	RF	85x45x23	controller
38133192	KM-RGBW-3Z-20	192/384	4x4 A	RF	85x45x23	prijímač 3-zónový
38133193	KM-RGBW-4Z-21	192/384	4x4 A	RF	85x45x23	prijímač 4-zónový
38133520	KM-RGBW-3Z-01				106x52x4	ovládač 3-zónový
38133530	KM-RGBW-4Z-01				120x52x21	ovládač 4-zónový



KM-RGB+WW+CW-10 12V-192W, 24V-240W  
Obj. kód 38133300



KM-RGB+WW+CW-20 12V-240W, 24V-480W  
Obj. kód 38133541



KM-RGB+WW+CW-8Z-03  
Obj. kód 38133542



KM-RGB+WW+CW-8Z-30 12V-240W, 24V-480W  
Obj. kód 38133543

## RGB + WW+CW CONTROLLER

12/24 V

IP 20



obj. kód	typ	W	I	ovládanie	rozmer (mm)	funkcia
38133300	KM-RGB+WW+CW-10	192/240	16A	RF	100x47x23	controller
38133541	KM-RGB+WW+CW-20	240/480	5x4A	RF	85x45x23	controller
38133542	KM-RGB+WW+CW-8Z-03			RF	158x54x17	8-zónový ovládač
38133543	KM-RGB+WW+CW-8Z-30	240/480	5x4A	RF	85x45x23	8-zónový prijímač



# Ovládanie LED pásov

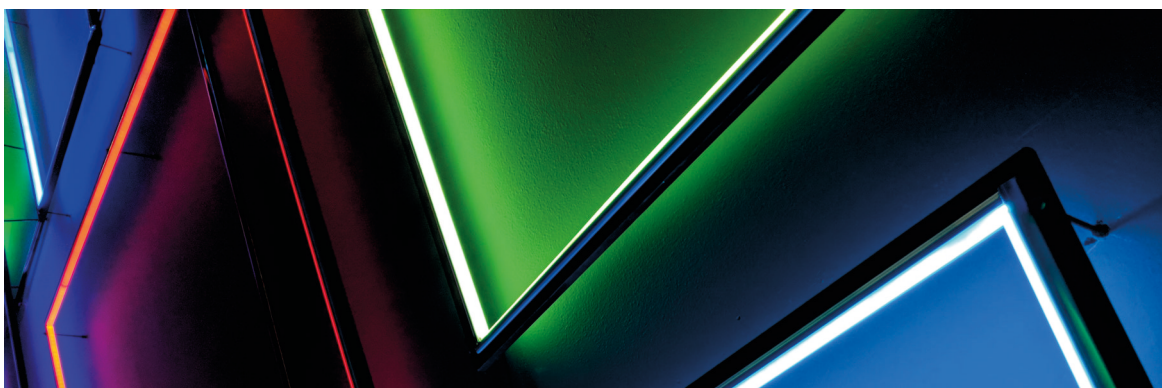

KM-W-33 WiFi 8A  
Obj. kód 38443097



KM-RGBW-33, 96-192 W, IR, WiFi  
Obj. kód 38132096



KM-RGB-33, 72-144W, IR, WiFi  
Obj. kód 38132074

## WiFi CONTROLLER

12/24 V

IP 20



obj. kód	typ	W pri 12/24 V	I	ovládanie	svetlo LED pásu	rozmer (mm)	funkcia
38443097	KM-W-33	96/192	8 A	WiFi	biele, stmievateľé	60x23x10	stmievač
38132074	KM-RGB-33	72/144	3x 2A	IR, WiFi	RGB	60x23x10	controller
38132096	KM-RGBW-33	96/192	4x 2A	IR, WiFi	RGB + biele	60x23x10	controller



KMA-36-12-V, s vypínačom  
Obj. kód 30310037

## KMA-V

ochrana proti  
skratu, preťaženiu,  
pracovná teplota:  
-20°C až +45°C

100-240 V

50/60 Hz

IP 20



obj. kód	typ	W	U výstup	I	rozmer (mm)
30310037	KMA-36-12-V	36	12 V	3 A	95x46x32



KMA-24-12, obj. kód 30310024  
KMA-24-24, obj. kód 30320024



KMA-36-12, obj. kód 30310036  
KMA-36-24, obj. kód 30320036



KMA-60-12, obj. kód 30310060  
KMA-60-24, obj. kód 30320060

## KMA

ochrana proti  
skratu, preťaženiu,  
pracovná teplota:  
-20°C až +45°C

100-240 V

50/60 Hz

IP 20



obj. kód	typ	W	U výstup	I	rozmer (mm)
30310024	KMA-24-12	24	12 V	2 A	83x43x30
30310036	KMA-36-12	36	12 V	3 A	95x46x32
30310060	KMA-60-12	60	12 V	5 A	122x60x39
30320024	KMA-24-24	24	24 V	1 A	83x43x30
30320036	KMA-36-24	36	24 V	1,5 A	95x46x32
30320060	KMA-60-24	60	24 V	2,5 A	122x60x39



# Napájacie zdroje LED

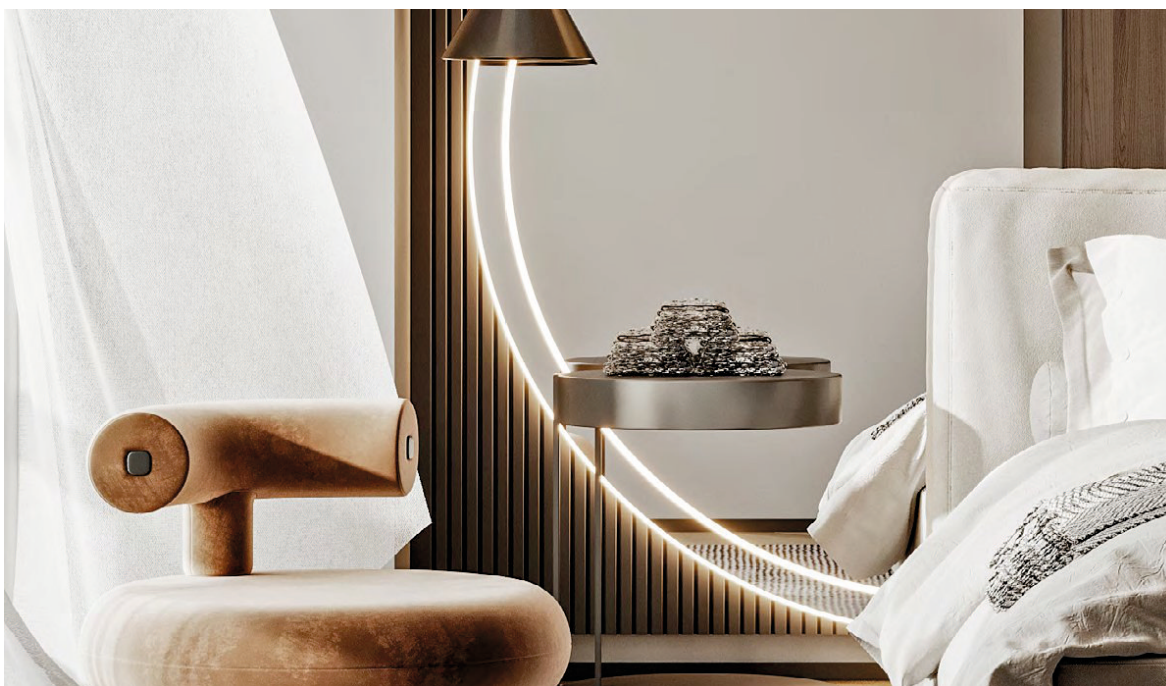

KMT-15-12, obj. kód 30410015



KMT-25-12, obj. kód 30410025  
KMT-25-24, obj. kód 30420025



KMT-40-12, obj. kód 30410040  
KMT-40-24, obj. kód 30420040



KMT-60-12, obj. kód 30410060  
KMT-60-24, obj. kód 30420060



KMT-80-12, obj. kód 30410080  
KMT-80-24, obj. kód 30420080



KMT-100-12, obj. kód 30410100  
KMT-100-24, obj. kód 30420100



KMT-120-12, obj. kód 30410120  
KMT-120-24, obj. kód 30420120



KMT-150-12, obj. kód 30410150  
KMT-150-24, obj. kód 30420150



KMT-200-12, obj. kód 30410200  
KMT-200-24, obj. kód 30420200



KMT-240-12, obj. kód 30410240  
KMT-240-24, obj. kód 30420240



KMT-360-12, obj. kód 30410360  
KMT-360-24, obj. kód 30420360

## KMT

ochrana  
proti skratu,  
pracovná  
teplota:  
-20°C  
až +45°C

50/60 Hz

IP 20



obj. kód	typ	W	U	V	I	rozmer (mm)
30410015	KMT-15-12	15	170-240V	12	1,25 A	76x40x20
30410025	KMT-25-12	25	170-240V	12	2,1 A	85x56x38
30410040	KMT-40-12	40	170-240V	12	3,3 A	127x43x35
30410060	KMT-60-12	60	170-240V	12	5 A	160x40x33
30410080	KMT-80-12	80	170-240V	12	6,67 A	160x40x33
30410100	KMT-100-12	100	170-240V	12	8,3 A	200x60x38
30410120	KMT-120-12	120	170-240V	12	10 A	200x60x38
30410150	KMT-150-12	150	170-240V	12	12,5 A	200x60x38
30410200	KMT-200-12	200	170-240V	12	16,7 A	225x70x40
30410240	KMT-240-12	240	170-240V	12	20 A	225x70x40
30410360	KMT-360-12	360	170-240V	12	30 A	225x70x40

obj. kód	typ	W	U	V	I	rozmer (mm)
30420025	KMT-25-24	25	100-240V	24	1,05A	85x56x38
30420040	KMT-40-24	40	100-240V	24	1,65A	127x43x35
30420060	KMT-60-24	60	100-240V	24	2,5A	160x40x33
30420080	KMT-80-24	80	100-240V	24	3,13A	160x40x33
30420100	KMT-100-24	100	100-240V	24	4,17A	200x60x38
30420120	KMT-120-24	120	100-240V	24	5A	200x60x38
30420150	KMT-150-24	150	100-240V	24	6,25A	200x60x38
30420200	KMT-200-24	200	100-240V	24	8,35A	225x70x40
30420240	KMT-240-24	240	100-240V	24	10A	225x70x40
30420360	KMT-360-24	360	100-240V	24	15A	225x70x40

# Napájacie zdroje LED



KML-12-12, obj. kód 32210012



KML-24-12, obj. kód 32210024  
KML-24-24, obj. kód 32220024



KML-36-12, obj. kód 32210036  
KML-36-24, obj. kód 32220036



KML-60-12, obj. kód 32210060  
KML-60-24, obj. kód 32220060



KML-80-12, obj. kód 32210080  
KML-80-24, obj. kód 32220080



KML-100-12, obj. kód 32210100  
KML-100-24, obj. kód 32220100

**KML**  
ochrana proti  
skratu, preťaženiu,  
prepätiu,  
pracovná teplota:  
-20°C až +45°C

**110-240 V**

**50/60 Hz**

**IP 20**



obj. kód	typ	W	V	I	rozmer (mm)
32210012	KML-12-12	12	12	1 A	89 x 39 x 23
32210024	KML-24-12	24	12	2 A	115 x 44 x 28
32210036	KML-36-12	36	12	3 A	139 x 44 x 28
32210060	KML-60-12	60	12	5 A	166 x 44 x 28
32210080	KML-80-12	80	12	6,67 A	166 x 44 x 28
32210100	KML-100-12	100	12	8,34 A	166 x 46 x 30

obj. kód	typ	W	V	I	rozmer (mm)
32220024	KML-24-24	24	24	1 A	115 x 44 x 28
32220036	KML-36-24	36	24	1,5 A	139 x 44 x 28
32220060	KML-60-24	60	24	2,5 A	166 x 44 x 28
32220080	KML-80-24	80	24	3,33A	166 x 44 x 28
32220100	KML-100-24	100	24	4,17 A	166 x 46 x 30



KMM-12-12, obj. kód 30510012



KMM-40-12, obj. kód 30510040



**KMM**  
ochrana proti  
skratu, preťaženiu,  
prepätiu,  
tepelná ochrana  
pracovná teplota:  
-20°C až +40°C

**220-240 V**

**50/60 Hz**

**IP 20**



obj. kód	typ	W	V	I	rozmer (mm)
30510012	KMM-12-12	12	12	1 A	90x40x24
30510040	KMM-40-12	40	12	3,3 A	160x58x20



# Napájacie zdroje LED



## KMC

ochrana proti skratu, preťaženiu, prepätiu, tepelná ochrana  
pracovná teplota: -20°C až +40°C

200-240 V

50/60 Hz

IP 20



KMC-15-12, obj. kód 30610015



KMC-20-12, obj. kód 30610020



KMC-30-12, obj. kód 30610030



KMC-50-12, obj. kód 30610050



KMC-60-12, obj. kód 30610060



KMC-75-12, obj. kód 30610075



KMC-100-12, obj. kód 30610100

obj. kód	typ	W	V	I	rozmer (mm)
30610015	KMC-15-12	15	12	1,25 A	103x35,5x16,5
30610020	KMC-20-12	20	12	1,66 A	103x35,5x16,5
30610030	KMC-30-12	30	12	2,5A	160x58x18
30610050	KMC-50-12	50	12	4,16A	160x58x18
30610060	KMC-60-12	60	12	5A	160x58x18
30610075	KMC-75-12	75	12	6,25A	160x58x18
30610100	KMC-100-12	100	12	8,33A	160x58x18



FTPC20V12-E, obj. kód 31610020  
FTPC20V24-E, obj. kód 31620020



FTPC30V12-C2, obj. kód 31610030  
FTPC30V24-C2, obj. kód 31620030



FTPC50V12-C2, obj. kód 31610050  
FTPC50V24-C2, obj. kód 31620050



FTPC75V12-C, obj. kód 31610075  
FTPC75V24-C, obj. kód 31620075



## FTPC-C

ochrana proti skratu, preťaženiu, prepätiu,  
pracovná teplota: -20- +45°C

180-264 V

47-63 Hz

IP 20



FTPC15V12-E, obj. kód 31610015



FTPC100V12-E, obj. kód 31610100  
FTPC100V24-E, obj. kód 31620100

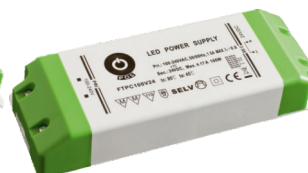

FTPC150V12-E, obj. kód 31610150  
FTPC150V24-E, obj. kód 31620150

obj. kód	typ	W	V	I	rozmer (mm)
31610015	FTPC15V12-E	15	12	1,25 A	103x35,5x16,5
31610020	FTPC20V12-E	20	12	1,67 A	103x35,5x16,5
31610030	FTPC30V12-C2	30	12	2,5 A	154x50x14
31610050	FTPC50V12-C2	50	12	4,17 A	159,9x57,8x18
31610075	FTPC75V12-C	75	12	6,25 A	201x64x30
31610100	FTPC100V12-E	100	12	8,33 A	179,4x62,5x30,6
31610150	FTPC150V12-E	150	12	11 A	179,4x62,5x30,6
31620020	FTPC20V24-E	20	24	0,84 A	103 x 35,5 x 16,5
31620030	FTPC30V24-C2	30	24	1,25 A	154x50x14
31620050	FTPC50V24-C2	50	24	2,08 A	159,9x57,8x18
31620075	FTPC75V24-C	75	24	3,12 A	201x64x30
31620100	FTPC100V24-E	100	24	4,17 A	179,4x62,5x30,6
31620150	FTPC150V24-E	150	24	6,25 A	179,4x62,5x30,6

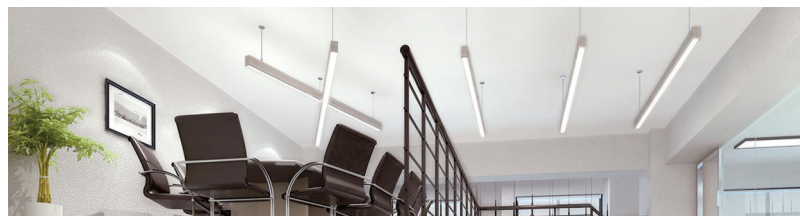

FTPC150V12-S, obj. kód 31710150  
FTPC150V24-S, obj. kód 31720150



FTPC200V12-S, obj. kód 31710200  
FTPC200V24-S, obj. kód 31720200



FTPC240V24-S, obj. kód 31720240

obj. kód	typ	W	V	I	rozmer (mm)
31710150	FTPC150V12-S	150	12	11 A	323 x 30 x 22
31710200	FTPC200V12-S	180	12	15 A	356,4x32,1x22,3
31720150	FTPC150V24-S	150	24	6,25 A	323 x 30 x 22
31720200	FTPC200V24-S	200	24	8,33 A	356,4x32,1x22,3
31720240	FTPC240V24-S	240	24	10 A	356,4x32,1x22,3



## FTPC-S

ochrana proti skratu,  
preťaženiu, prepätiu,  
pracovná teplota:  
-20- +50°C

180-264 V

47-63 Hz

IP 20



GTPC-30-12-S, obj. kód 32610030  
GTPC-30-24-S, obj. kód 32620030



GTPC-45-12-S, obj. kód 32610045  
GTPC-45-24-S, obj. kód 32620045



GTPC-60-12-S, obj. kód 32610060  
GTPC-60-24-S, obj. kód 32620060



GTPC-75-12-S, obj. kód 32610075  
GTPC-75-24-S, obj. kód 32620075



GTPC-100-12-S, obj. kód 32610100  
GTPC-100-24-S, obj. kód 32620100

obj. kód	typ	W	V	I	rozmer (mm)
32610030	GTPC-30-12-S	30	12	2,5 A	251x30x16,5
32610045	GTPC-45-12-S	45	12	3,75 A	251x30x16,5
32610060	GTPC-60-12-S	60	12	5 A	305x30x17
32610075	GTPC-75-12-S	75	12	6,25 A	305x30x17
32610100	GTPC-100-12-S	100	12	8,3 A	320x30x18,2
32620030	GTPC-30-24-S	30	24	1,25 A	251x30x16,5
32620045	GTPC-45-24-S	45	24	1,87 A	251x30x16,5
32620060	GTPC-60-24-S	60	24	2,5 A	305x30x17
32620075	GTPC-75-24-S	75	24	3,12 A	305x30x17
32620100	GTPC-100-24-S	100	24	4,17 A	320x30x18,2



## GTPC-S

ochrana proti skratu,  
preťaženiu, prepätiu,  
pracovná teplota:  
-20- +50°C

180-264 V

47-63 Hz

IP 20





# Napájacie zdroje LED



KMK-15-12, obj. kód 30710015  
KMK-15-24, obj. kód 30720015



KMK-30-12, obj. kód 30710030  
KMK-30-24, obj. kód 30720030



KMK-06-12, obj. kód 30710006  
KMK-06-24, obj. kód 30720006

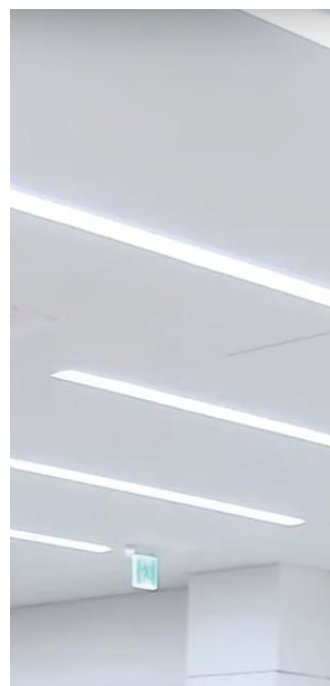

## KMK

ochrana proti skratu,  
preťaženiu, prepätiu,  
pracovná teplota:  
-10°C až +50 °C

IP 67

100-240 V



obj. kód	typ	W	V	I	rozmer (mm)
30710006	KMK-06-12	6	12	0,5A	55x28x23
30710015	KMK-15-12	15	12	1,25A	49x49x23
30710030	KMK-30-12	30	12	2,5A	49x49x23
30720006	KMK-06-24	6	24	0,25A	55x28x23
30720015	KMK-15-24	15	24	0,63A	49x49x23
30720030	KMK-30-24	30	24	1,25A	49x49x23



KMP-36-12, obj. kód 32310036  
KMP-36-24, obj. kód 32320036



KMP-60-12, obj. kód 32310060  
KMP-60-24, obj. kód 32320060



KMP-100-12, obj. kód 32310100  
KMP-100-24, obj. kód 32320100  
KMP-100-48, obj. kód 32340100



KMP-150-12, obj. kód 32310150  
KMP-150-24, obj. kód 32320150  
KMP-150-48, obj. kód 32340150



KMP-200-12, obj. kód 32310200  
KMP-200-24, obj. kód 32320200  
KMP-200-48, obj. kód 32340200



KMP-300-12, obj. kód 32310300  
KMP-300-24, obj. kód 32320300  
KMP-300-48, obj. kód 32340300



KMP-400-12, obj. kód 32310400  
KMP-400-24, obj. kód 32320400  
KMP-400-48, obj. kód 32340400



KMP-500-12, obj. kód 32310500  
KMP-500-24, obj. kód 32320500  
KMP-500-48, obj. kód 32340500

## KMP

ochrana proti  
skratu, preťaženiu,  
prepätiu,  
prac. teplota:  
-40- +85°C

50-60 Hz

IP 67



obj. kód	typ	W	U	V	I	rozmer (mm)	obj. kód	typ	W	U	V	I	rozmer (mm)
32310036	KMP-36-12	36	100-265V	12	3A	125x38x21	32320150	KMP-150-24	150	175-265V	24	6,25A	210x53x19
32310060	KMP-60-12	60	100-265V	12	5A	150x38x21	32320200	KMP-200-24	200	175-265V	24	8,33A	215x60x24
32310100	KMP-100-12	100	100-265V	12	8,33A	195x53x19	32320300	KMP-300-24	300	175-265V	24	12,5A	250x68x30
32310150	KMP-150-12	150	175-265V	12	12,5A	210x53x19	32320400	KMP-400-24	400	175-265V	24	16,67A	248x78x32
32310200	KMP-200-12	200	175-265V	12	16,7A	215x60x24	32320500	KMP-500-24	500	175-265V	24	20,83A	268x78x32
32310300	KMP-300-12	300	175-265V	12	25A	250x68x30	32340100	KMP-100-48	100	175-265V	48	2,08A	195x53x19
32310400	KMP-400-12	400	175-265V	12	33,33A	248x78x32	32340150	KMP-150-48	150	175-265V	48	3,13A	210x53x19
32310500	KMP-500-12	500	175-265V	12	41,6A	268x78x32	32340200	KMP-200-48	200	175-265V	48	4,17A	215x60x24
32320036	KMP-36-24	36	100-265V	24	1,5A	125x38x21	32340300	KMP-300-48	300	175-265V	48	6,25A	250x68x30
32320060	KMP-60-24	60	100-265V	24	2,5A	150x38x21	32340400	KMP-400-48	400	175-265V	48	8,33A	248x78x32
32320100	KMP-100-24	100	100-265V	24	4,17A	195x53x19	32340500	KMP-500-48	500	175-265V	48	10,42A	268x78x32

# Napájacie zdroje LED



KMV-24-12  
Obj. kód 30810024

KMV-40-12  
Obj. kód 30810040

KMV-60-12  
Obj. kód 30810060



KMV-75-12  
Obj. kód 30810075

KMV-100-12  
Obj. kód 30810100

## KMV

ochrana proti  
skratu, preťaženiu,  
prepätiu,  
pracovná teplota:  
-20°C až +40°C

220-240 V

50/60 Hz

IP 67



obj. kód	typ	W	V	I	rozmer (mm)
30810024	KMV-24-12	24	12	2 A	118x35x26
30810040	KMV-40-12	40	12	3,3 A	148x40x30
30810060	KMV-60-12	60	12	5 A	163x43x33
30810075	KMV-75-12	75	12	6,25 A	190x52x37
30810100	KMV-100-12	100	12	8,3 A	190x52x37



GPV-12-12, obj. kód 31810012  
GPV-12-24, obj. kód 31820012

GPV-18-12, obj. kód 31810018  
GPV-18-24, obj. kód 31820018

GPV-20-12, obj. kód 31810020  
GPV-20-24, obj. kód 31820020

GPV-35-12, obj. kód 31810035  
GPV-35-24, obj. kód 31820035



GPV-50-12, obj. kód 31810050  
GPV-50-24, obj. kód 31820050

GPV-60-12, obj. kód 31810060  
GPV-60-24, obj. kód 31820060

GPV-75-12, obj. kód 31810075  
GPV-75-24, obj. kód 31820075

GPV-100-12, obj. kód 31810100  
GPV-100-24, obj. kód 31820100



GPV-120-12, obj. kód 31810120  
GPV-120-24, obj. kód 31820120

GPV-150-12, obj. kód 31810150  
GPV-150-24, obj. kód 31820150

GPV-200-12, obj. kód 31810200  
GPV-200-24, obj. kód 31820200

GLG-300-12, obj. kód 31910300  
GLG-300-24, obj. kód 31920300

## GPV GLG

ochrana proti  
skratu, preťaženiu,  
prepätiu,  
pracovná teplota:  
-30 – +70°C

90-264 V

47-63 Hz

IP 67



obj. kód	typ	W	V	I	rozmer (mm)
31810012	GPV-12-12	12	12	1 A	129,5x25x20
31810018	GPV-18-12	18	12	1,5 A	129,5x25x21
31810020	GPV-20-12	20	12	2 A	140x32x25
31810035	GPV-35-12	35	12	3 A	149x32x28
31810050	GPV-50-12	50	12	4,2 A	148x40x30
31810060	GPV-60-12	60	12	5 A	162x42x33
31810075	GPV-75-12	75	12	6 A	162x42x33
31810100	GPV-100-12	100	12	8,3 A	190x53x37
31810120	GPV-120-12	120	12	10 A	203x70x45
31810150	GPV-150-12N	150	12	12,5 A	203x70x45
31810200	GPV-200-12	200	12	16 A	205x70x45
31910300	GLG-300-12	300	12	25 A	285x96x50

obj. kód	typ	W	V	I	rozmer (mm)
31820012	GPV-12-24	12	24	0,5 A	129,5x25x20
31820018	GPV-18-24	18	24	0,75 A	129,5x25x21
31820020	GPV-20-24	20	24	1 A	140x32x25
31820035	GPV-35-24	35	24	1,5 A	149x32x28
31820050	GPV-50-24	50	24	2,1 A	148x40x30
31820060	GPV-60-24	60	24	2,5 A	162x42x33
31820075	GPV-75-24	75	24	3 A	162x42x33
31820100	GPV-100-24	100	24	4,2 A	190x53x37
31820120	GPV-120-24	120	24	5 A	203x70x45
31820150	GPV-150-24	150	24	6 A	203x70x45
31820200	GPV-200-24	200	24	8,3 A	205x70x45
31920300	GLG-300-24	300	24	12,5 A	285x96x50



# Napájacie zdroje LED



## GPC

ochrana proti skratu,  
preťaženiu, prepätiu,  
pracovná teplota:  
-10- +50°C

90-264 V

47-63 Hz

IP 67



GPC-9-350, obj. kód 37200093  
GPC-9-700, obj. kód 37200097

GPC-20-350, obj. kód 37200203  
GPC-20-700, obj. kód 37200207



GPC-35-350, obj. kód 37200353  
GPC-35-700, obj. kód 37200357  
GPC-35-1050, obj. kód 37200310  
GPC-35-1400, obj. kód 37200314

GPC-60-1050, obj. kód 37200610  
GPC-60-1400, obj. kód 37200614  
GPC-60-1750, obj. kód 37200617

obj. kód	typ	W	V	I	rozmer (mm)
37200093	GPC-9-350	9	3-24	350 mA	130x25x21
37200097	GPC-9-700	9	3-12	700 mA	130x25x21
37200203	GPC-20-350	20	9-48	350 mA	140x32x25
37200207	GPC-20-700	20	3-30	700 mA	140x32x25
37200353	GPC-35-350	35	30-80	350 mA	148x32x28
37200357	GPC-35-700	35	9-48	700 mA	148x32x28
37200310	GPC-35-1050	35	9-30	1050 mA	148x32x28
37200314	GPC-35-1400	35	9-24	1400 mA	148x32x28
37200610	GPC-60-1050	60	12-60	1050 mA	162x42x33
37200614	GPC-60-1400	60	9-42	1400 mA	162x42x33
37200617	GPC-60-1750	60	9-36	1750 mA	162x42x33



DIN60W12, obj. kód 34110060  
DIN60W24, obj. kód 34120060



DIN15W12, obj. kód 34110015  
DIN15W24, obj. kód 34120015



DIN100W12, obj. kód 34110100  
DIN100W24, obj. kód 34120100



DIN30W12, obj. kód 34110030  
DIN30W24, obj. kód 34120030

## DIN

ochrana proti skratu,  
preťaženiu, prepätiu,  
pracovná teplota:  
-25- +50°C

180-264 V

47-63 Hz

IP 20



obj. kód	typ	W	V	I	rozmer (mm)
34110015	DIN15W12	15	12	1,25 A	25 x 92,5 x 56
34110030	DIN30W12	30	12	2,5 A	62,5 x 93 x 56
34110060	DIN60W12	60	12	5 A	78 x 93 x 56
34110100	DIN100W12	100	12	8,3 A	32,7 x 21,6 x 33,5
34120015	DIN15W24	15	24	0,63 A	25 x 92,5 x 56
34120030	DIN30W24	30	24	1,25 A	62,5 x 93 x 56
34120060	DIN60W24	60	24	2,5 A	78 x 93 x 56
34120100	DIN100W24	100	24	4,15 A	32,7 x 21,6 x 33,5



# Napájacie zdroje LED



DRC-12V10W, obj. kód 34210010  
DRC-24V10W, obj. kód 34220010



DRC-12V30W, obj. kód 34210030  
DRC-24V30W, obj. kód 34220030



DRC-12V60W, obj. kód 34210060  
DRC-24V60W, obj. kód 34220060



DRC-12V100W, obj. kód 34210100  
DRC-24V100W, obj. kód 34220100



## DRC

ochrana proti  
skratu, preťaženiu,  
prepätiu,  
pracovná teplota:  
-25- +70°C

90-264 V

47-63 Hz

IP 20



obj. kód	typ	W	V	I	rozmer (mm)
34210010	DRC-12V10W	10	12	0,83 A	18 x 91 x 55,6
34210030	DRC-12V30W	30	12	2,1 A	53 x 91 x 55,6
34210060	DRC-12V60W	60	12	4,5 A	71 x 91 x 55,6
34210100	DRC-12V100W	72	12	6 A	89,9 x 91 x 55,6
34220010	DRC-24V10W	10	24	0,42 A	18 x 91 x 55,6
34220030	DRC-24V30W	30	24	1,25 A	53 x 91 x 55,6
34220060	DRC-24V60W	60	24	2,5 A	71 x 91 x 55,6
34220100	DRC-24V100W	100	24	3,8 A	89,9 x 91 x 55,6



DRL-12V75W1AZ, obj. kód 34310075  
DRL-24V75W1AZ, obj. kód 34320075



DRL-12V120W1EN, obj. kód 34310120  
DRL-24V120W1EN, obj. kód 34320120



DRL-12V240W1EN, obj. kód 34310120  
DRL-24V240W1EN, obj. kód 34320120



DRL-24V480W1EN, obj. kód 34320480



## DRL

ochrana proti  
skratu, preťaženiu,  
prepätiu, tepelná  
ochrana,  
pracovná teplota:  
-20- +70°C

90 - 264 V

47 - 63 Hz

IP 20



obj. kód	typ	W	V	I	rozmer (mm)
34310075	DRL-12V75W1AZ	75	12	6,25 A	123,6x27x102
34310120	DRL-12V120W1EN	120	12	10 A	123,6x30x116,8
34310240	DRL-12V240W1EN	240	12	20 A	123,6x40x116,8
34320075	DRL-24V75W1AZ	75	24	3,125 A	123,6x27x102
34320120	DRL-24V120W1EN	120	24	5 A	123,6x30x116,8
34320240	DRL-24V240W1EN	240	24	10 A	123,6x30x116,8
34320480	DRL-24V480W1EN	480	24	20 A	123,6x56x116,8



## ALU profily LED

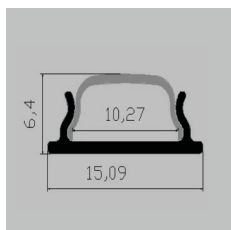

KM24-S



24-TK

24-MK

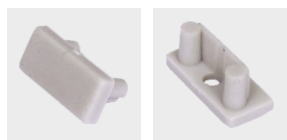

KM24K-S

KM24K-S-O

### KM24

na povrch

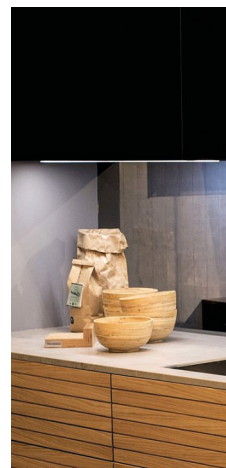

#### LIŠTA

obj. kód	typ	dĺžka	farba
40240001	KM24-S 1M	1 m	strieborná
40240002	KM24-S 2M	2 m	strieborná

#### KRYT

obj. kód	typ	dĺžka	prevedenie
40241041	24-TK 1M	1 m	klik číry
40241042	24-TK 2M	2 m	klik číry
40241051	24-MK 1M	1 m	klik matný
40241052	24-MK 2M	2 m	klik matný

#### PRÍSLUŠENSTVO

obj. kód	typ	príslušenstvo
40242000	KM24K-S	koncovka
40242001	KM24K-S-O	koncovka s otvorom

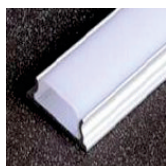
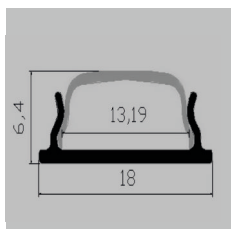
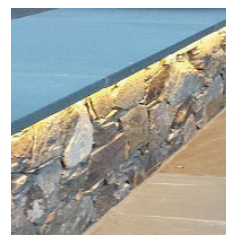

KM34-S

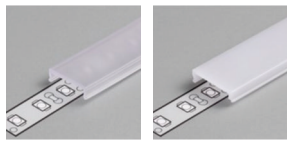

34-TK

34-MK



KM34K-S

KM34K-S-O

KM34P

### KM34

na povrch

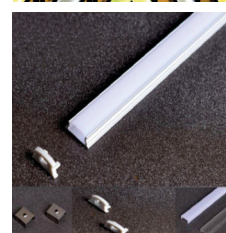
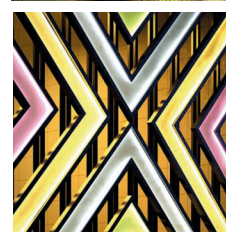
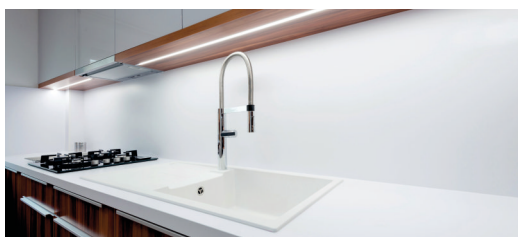

#### LIŠTA

obj. kód	typ	dĺžka	farba
40340001	KM34-S 1M	1 m	strieborná
40340002	KM34-S 2M	2 m	strieborná

#### KRYT

obj. kód	typ	dĺžka	prevedenie
40341041	34-TK 1M	1 m	klik číry
40341042	34-TK 2M	2 m	klik číry
40341051	34-MK 1M	1 m	klik matný
40341052	34-MK 2M	2 m	klik matný

#### PRÍSLUŠENSTVO

obj. kód	typ	príslušenstvo
40342000	KM34K-S	koncovka
40342001	KM34K-S-O	koncovka s otvorom
40343000	KM34P	príchytky

# ALU profily LED

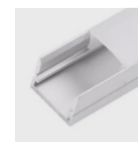
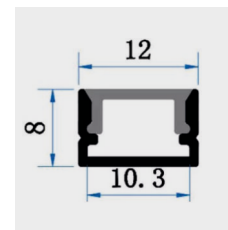
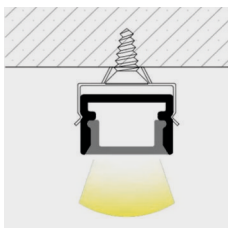

KM33-S



## LIŠTA

obj. kód	typ	dĺžka	farba
40330001	KM33-S 1M	1 m	strieborná
40330002	KM33-S 2M	2 m	strieborná

## KRYT

obj. kód	typ	dĺžka	prevedenie
40331041	33-TK 1M	1 m	klik číry
40331042	33-TK 2M	2 m	klik číry
40331051	33-MK 1M	1 m	klik matný
40331052	33-MK 2M	2 m	klik matný

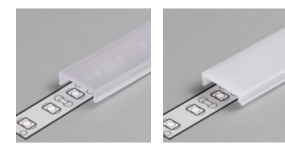

33-TK

33-MK

## PRÍSLUŠENSTVO

obj. kód	typ	príslušenstvo
40332000	KM33K-S	koncovka
40332001	KM33K-S-O	koncovka s otvorom
40333000	KM33P-S	príchytky



KM33K-S-O

KM33K-S

KM33P-S

**KM33**

na povrch

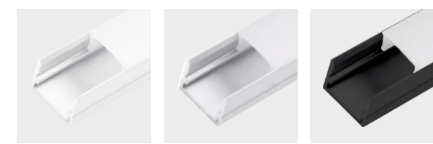
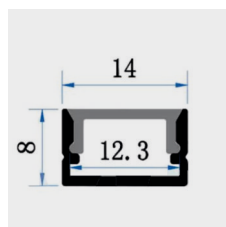
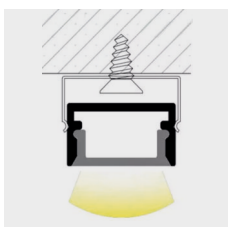

KM35-B

KM35-S

KM35-C



## LIŠTA

obj. kód	typ	dĺžka	farba
40350001	KM35-S 1M	1 m	strieborná
40350002	KM35-S 2M	2 m	strieborná
40350101	KM35-B 1M	1 m	biela
40350102	KM35-B 2M	2 m	biela
40350201	KM35-C 1M	1 m	čierna
40350202	KM35-C 2M	2 m	čierna

## KRYT

obj. kód	typ	dĺžka	prevedenie
40351041	35-TK 1M	1 m	klik číry
40351042	35-TK 2M	2 m	klik číry
40351051	35-MK 1M	1 m	klik matný
40351052	35-MK 2M	2 m	klik matný

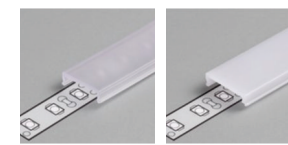

35-TK

35-MK

## PRÍSLUŠENSTVO

obj. kód	typ	príslušenstvo
40352000	KM35K-S	koncovka strieborná
40352001	KM35K-S-O	koncovka s otvorom strieborná
40352002	KM35K-B	koncovka biela
40352003	KM35K-B-O	koncovka s otvorom biela
40352004	KM35K-C	koncovka čierna
40352005	KM35K-C-O	koncovka s otvorom čierna
40353000	KM35P-S	príchytky



KM35K-S-O  
KM35K-B-O  
KM35K-C-O

KM35K-S  
KM35K-B  
KM35K-C

KM35P-S

**KM35**

na povrch



## ALU profily LED

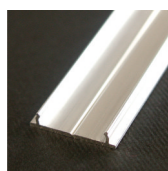
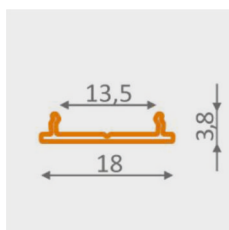

KM14

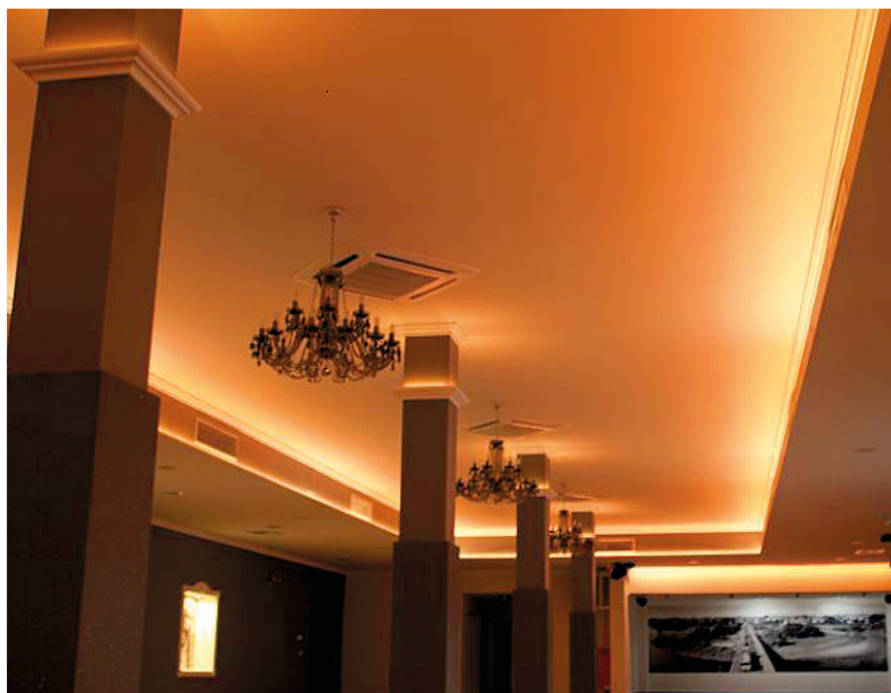

### KM14

na povrch

#### LIŠTA

obj. kód	typ	dĺžka	farba
40140401	KM14 1M	1 m	hliník
40140402	KM14 2M	2 m	hliník

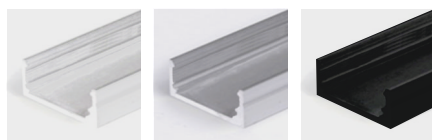

KM36-B

KM36-S

KM36-C

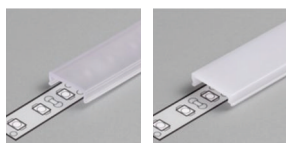

36-TK

36-MK

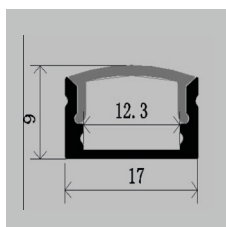

#### LIŠTA

obj. kód	typ	dĺžka	farba
40360001	KM36-S 1M	1 m	strieborná
40360002	KM36-S 2M	2 m	strieborná
40360101	KM36-B 1M	1 m	biela
40360102	KM36-B 2M	2 m	biela
40360201	KM36-C 1M	1 m	čierna
40360202	KM36-C 2M	2 m	čierna

#### KRYT

obj. kód	typ	dĺžka	prevedenie
40361041	36-TK 1M	1 m	klik číry
40361042	36-TK 2M	2 m	klik číry
40361051	36-MK 1M	1 m	klik matný
40361052	36-MK 2M	2 m	klik matný

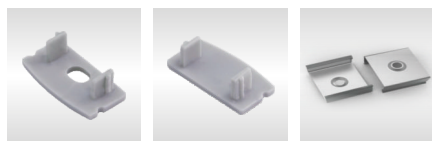

KM36K-S-O  
KM36K-B-O  
KM36K-C-O

KM36K-S  
KM36K-B  
KM36K-C

KM36P-S

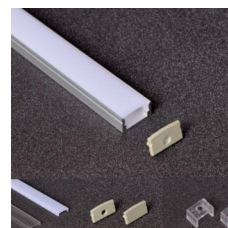

#### PRÍSLUŠENSTVO

obj. kód	typ	príslušenstvo
40362000	KM36K-S	koncovka strieborná
40362001	KM36K-S-O	koncovka s otvorom strieborná
40362002	KM36K-B	koncovka biela
40362003	KM36K-B-O	koncovka s otvorom biela
40362004	KM36K-C	koncovka čierna
40362005	KM36K-C-O	koncovka s otvorom čierna
40363001	KM36P-S	príchytka

### KM36

na povrch

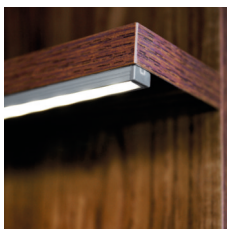
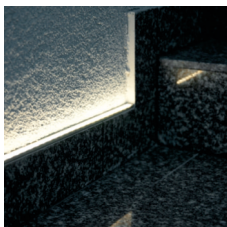
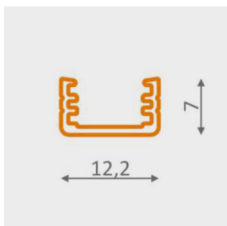

## LIŠTA

obj. kód	typ	dĺžka	farba
40120001	KM12-S 1M	1 m	strieborná
40120002	KM12-S 2M	2 m	strieborná
40120101	KM12-B 1M	1 m	biela
40120102	KM12-B 2M	2 m	biela
40120201	KM12-C 1M	1 m	čierna
40120202	KM12-C 2M	2 m	čierna

## KRYT

obj. kód	typ	dĺžka	prevedenie
40121011	12-T 1M	1 m	nasúvací číry
40121012	12-T 2M	2 m	nasúvací číry
40121021	12-S 1M	1 m	nasúvací mrazený
40121022	12-S 2M	2 m	nasúvací mrazený
40121031	12-M 1M	1 m	nasúvací matný
40121032	12-M 2M	2 m	nasúvací matný
40121041	12-TK 1m	1 m	klik číry
40121042	12-TK 2m	2 m	klik číry
40121051	12-MK 1m	1 m	klik matný
40121052	12-MK 2m	2 m	klik matný
40121053	12-MK 20m	20 m	klik matný

## PRÍSLUŠENSTVO

obj. kód	typ	príslušenstvo
40122000	KM12K-S	koncovka strieborná
40122001	KM12K-B	koncovka biela
40122002	KM12K-C	koncovka čierna
40123000	KM12P	príchytky
40125000	KM12R-S	roh strieborný
40125001	KM12R-B	roh biely
40125002	KM12R-C	roh čierny

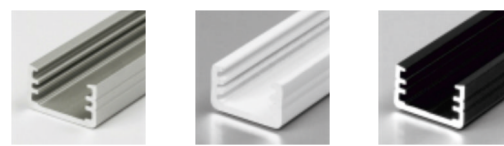

KM12-S

KM12-B

KM12-C

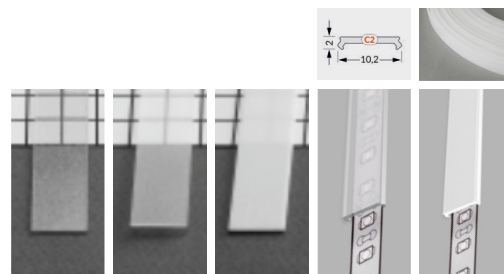

12-T

12-S

12-M

12-TK

12-MK



KM12K-S  
KM12K-B  
KM12K-C

KM12P

KM12R-S  
KM12R-B  
KM12R-C

## KM12

na povrch

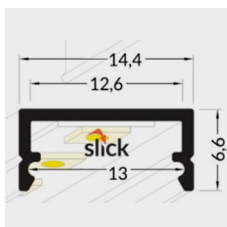
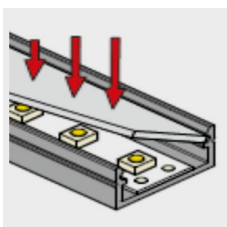

## LIŠTA

obj. kód	typ	dĺžka	farba
40260001	KM26-S 1M	1 m	strieborná
40260002	KM26-S 2M	2 m	strieborná
40260101	KM26-B 1M	1 m	biela
40260102	KM26-B 2M	2 m	biela
40260201	KM26-C 1M	1 m	čierna
40260202	KM26-C 2M	2 m	čierna

## KRYT

obj. kód	typ	dĺžka	prevedenie
40261011	26-T 1M	1 m	slick číry
40261012	26-T 2M	2 m	slick číry
40261021	26-S 1M	1 m	slick mrazený
40261022	26-S 2M	2 m	slick mrazený
40261031	26-M 1M	1 m	slick matný
40261032	26-M 2M	2 m	slick matný

## PRÍSLUŠENSTVO

obj. kód	typ	príslušenstvo
40262000	KM26K-S	koncovka strieborná
40262001	KM26K-B	koncovka biela
40262002	KM26K-C	koncovka čierna
40263000	KM26P-S	príchytky strieborné
40263001	KM26P-B	príchytky biely
40263002	KM26P-C	príchytky čierna



KM26-S

KM26-B

KM26-C

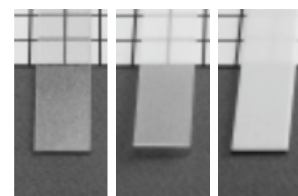

26-T

26-S

26-M

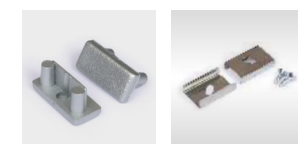

KM26K-S  
KM26K-B  
KM26K-C

KM26P-S  
KM26P-B  
KM26P-C

## KM26

na povrch



## ALU profily LED

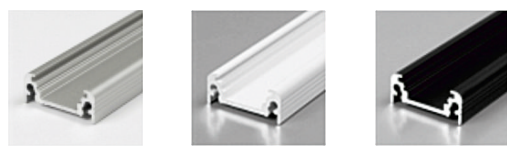

KM13-S

KM13-B

KM13-C

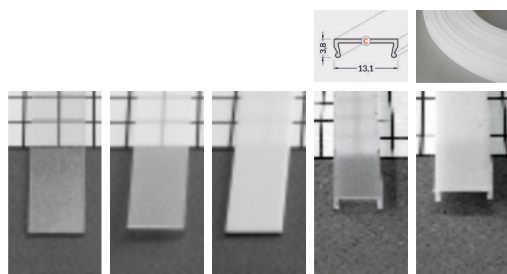

13-T

13-S

13-M

13-TK

13-MK



KM13K-S  
KM13K-B  
KM13K-C

KM13P

KM13PF

KM13S

KM13R-S  
KM13R-B  
KM13R-C

### KM13

na povrch

#### LIŠTA

obj. kód	typ	dĺžka	farba
40130001	KM13-S 1M	1 m	strieborná
40130002	KM13-S 2M	2 m	strieborná
40130101	KM13-B 1M	1 m	biela
40130102	KM13-B 2M	2 m	biela
40130201	KM13-C 1M	1 m	čierna
40130202	KM13-C 2M	2 m	čierna

#### KRYT

obj. kód	typ	dĺžka	prevedenie
40131011	13-T 1M	1 m	nasúvací číry
40131012	13-T 2M	2 m	nasúvací číry
40131021	13-S 1M	1 m	nasúvací mrazený
40131022	13-S 2M	2 m	nasúvací mrazený
40131031	13-M 1M	1 m	nasúvací matný
40131032	13-M 2M	2 m	nasúvací matný
40131041	13-TK 1M	1 m	klik číry
40131042	13-TK 2M	2 m	klik číry
40131051	13-MK 1M	1 m	klik matný
40131052	13-MK 2M	2 m	klik matný
40131053	13-MK 20M	20 m	klik matný

#### PRÍSLUŠENSTVO

obj. kód	typ	príslušenstvo
40132000	KM13K-S	koncovka strieborná
40132001	KM13K-B	koncovka biela
40132002	KM13K-C	koncovka čierna
40133000	KM13P	príchytká
40133001	KM13PF	príchytká flexi
40134000	KM13S	spojka
40135000	KM13R-S	roh strieborný
40135001	KM13R-B	roh biely
40135002	KM13R-C	roh čierny

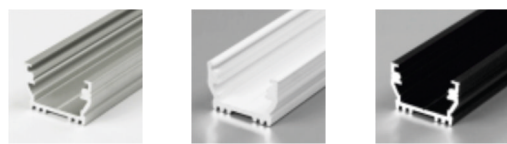
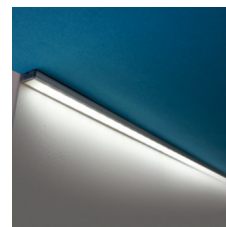
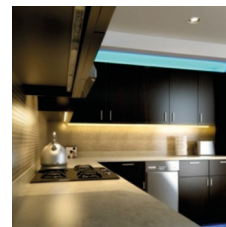
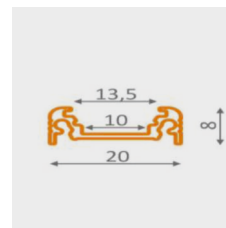

KM17-S

KM17-B

KM17-C

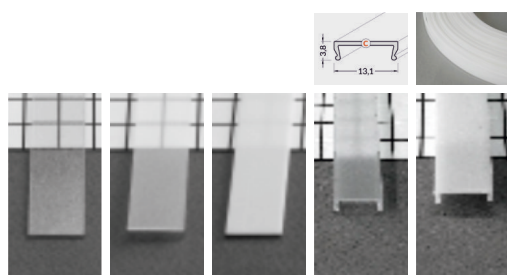

13-T

13-S

13-M

13-TK

13-MK



17-MK



KM17K-S  
KM17K-B  
KM17K-C

KM17KD

KM13PF

### KM17

na povrch

#### LIŠTA

obj. kód	typ	dĺžka	farba
40170001	KM17-S 1M	1 m	strieborná
40170002	KM17-S 2M	2 m	strieborná
40170101	KM17-B 1M	1 m	biela
40170102	KM17-B 2M	2 m	biela
40170201	KM17-C 1M	1 m	čierna
40170202	KM17-C 2M	2 m	čierna

#### KRYT

obj. kód	typ	dĺžka	prevedenie
40131011	13-T 1M	1 m	nasúvací číry
40131012	13-T 2M	2 m	nasúvací číry
40131021	13-S 1M	1 m	nasúvací mrazený
40131022	13-S 2M	2 m	nasúvací mrazený
40131031	13-M 1M	1 m	nasúvací matný
40131032	13-M 2M	2 m	nasúvací matný
40131041	13-TK 1M	1 m	klik číry
40131042	13-TK 2M	2 m	klik číry
40131051	13-MK 1M	1 m	klik matný
40131052	13-MK 2M	2 m	klik matný
40131053	13-MK 20M	20 m	klik matný
40171051	17-MK 1M	1 m	klik matný
40171052	17-MK 2M	2 m	klik matný

#### PRÍSLUŠENSTVO

obj. kód	typ	príslušenstvo
40172000	KM17K-S	koncovka strieborná
40172002	KM17K-B	koncovka biela
40172003	KM17K-C	koncovka čierna
40172001	KM17KD-S	koncovka D strieborná
40172004	KM17KD-B	koncovka D biela
40172005	KM17KD-C	koncovka D čierna
40133001	KM13PF	príchytká flexi

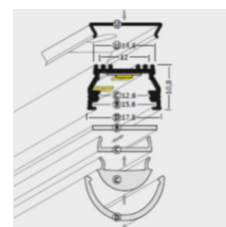
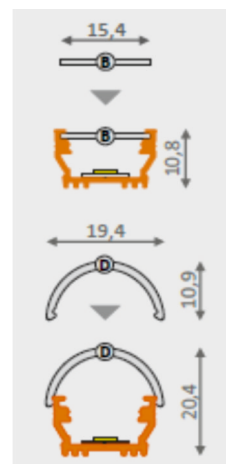

# ALU profily LED

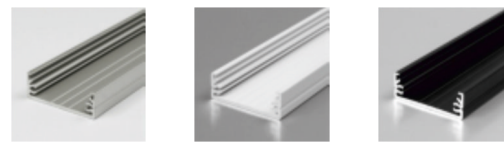
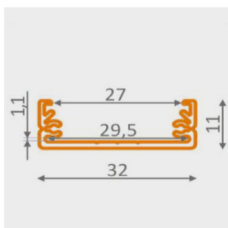

KM32-S

KM32-B

KM32-C



## LIŠTA

obj. kód	typ	dĺžka	farba
40320001	KM32-S 1M	1 m	strieborná
40320002	KM32-S 2M	2 m	strieborná
40320101	KM32-B 1M	1 m	biela
40320102	KM32-B 2M	2 m	biela
40320201	KM32-C 1M	1 m	čierna
40320202	KM32-C 2M	2 m	čierna

## KRYT

obj. kód	typ	dĺžka	prevedenie
40321011	32-T 1M	1 m	nasúvací číry
40321012	32-T 2M	2 m	nasúvací číry
40321021	32-S 1M	1 m	nasúvací mrazený
40321022	32-S 2M	2 m	nasúvací mrazený
40321031	32-M 1M	1 m	nasúvací matný
40321032	32-M 2M	2 m	nasúvací matný

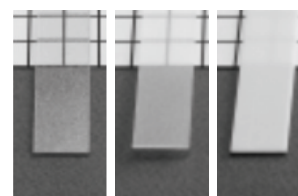

32-T

32-S

32-M

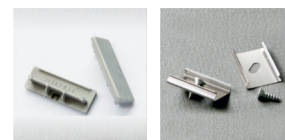

KM32K-S  
KM32K-B  
KM32K-C

KM32PF

## PRÍSLUŠENSTVO

obj. kód	typ	príslušenstvo
40322000	KM32K-S	koncovka strieborná
40322001	KM32K-B	koncovka biela
40322002	KM32K-C	koncovka čierna
40323001	KM32PF	príchytky flexi

**KM32**  
na povrch

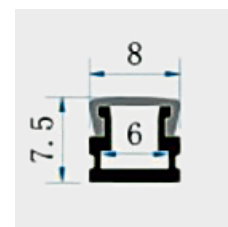
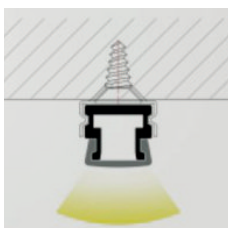

KM37-S

## LIŠTA

obj. kód	typ	dĺžka	farba
40370001	KM37-S 1M	1 m	strieborná
40370002	KM37-S 2M	2 m	strieborná

## KRYT

obj. kód	typ	dĺžka	prevedenie
40371041	37-TK 1M	1 m	klik číry
40371042	37-TK 2M	2 m	klik číry
40371051	37-MK 1M	1 m	klik matný
40371052	37-MK 2M	2 m	klik matný

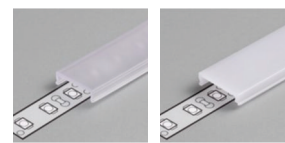

37-TK

37-MK



KM37K-S-O

KM37K-S

KM37P-S

## PRÍSLUŠENSTVO

obj. kód	typ	príslušenstvo
40372000	KM37K-S	koncovka
40372001	KM37K-S-O	koncovka s otvorom
40373000	KM37P-S	príchytky

**KM37**  
na povrch



## ALU profily LED

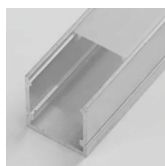
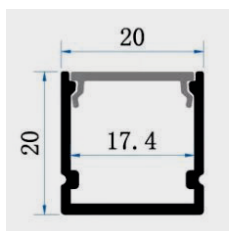

KM38-S

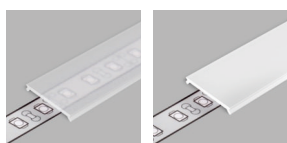

38-TK

38-MK



KM38K-S

KM38K-S-O

KM38P

### KM38

na povrch

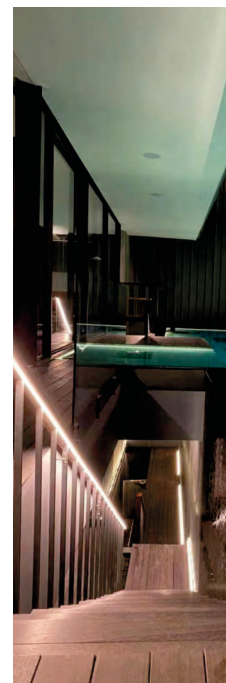
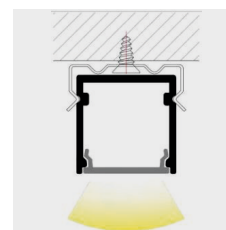
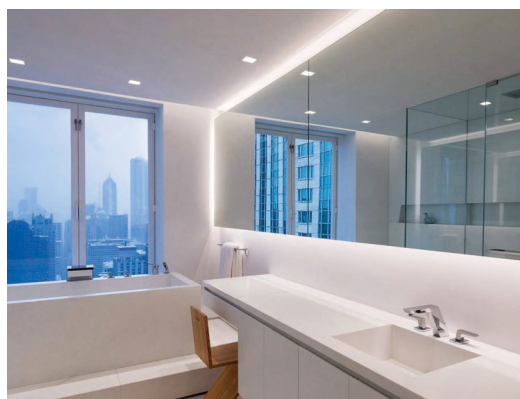

#### LIŠTA

obj. kód	typ	dĺžka	farba
40380001	KM38-S 1M	1 m	strieborná
40380002	KM38-S 2M	2 m	strieborná

#### KRYT

obj. kód	typ	dĺžka	prevedenie
40381041	38-TK 1M	1 m	klik číry
40381042	38-TK 2M	2 m	klik číry
40381051	38-MK 1M	1 m	klik matný
40381052	38-MK 2M	2 m	klik matný

#### PRÍSLUŠENSTVO

obj. kód	typ	príslušenstvo
40382000	KM38K-S	koncovka
40382001	KM38K-S-O	koncovka s otvorom
40383000	KM38P	príchytky

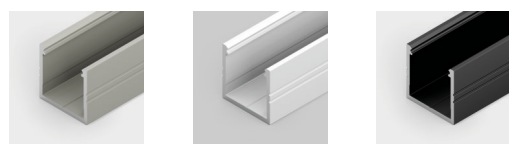

KM56-S

KM56-B

KM56-C

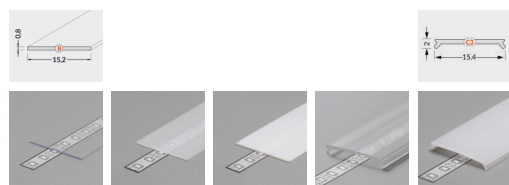

13-T

13-S

13-M

56-TK

56-MK

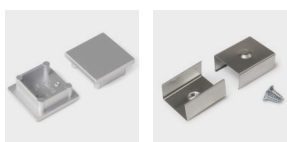

KM56K-S

KM56K-B

KM56K-C

KM56P-S

KM56P-B

KM56P-C

### KM56

na povrch

#### LIŠTA

obj. kód	typ	dĺžka	farba
40560001	KM56-S 1M	1 m	strieborná
40560002	KM56-S 2M	2 m	strieborná
40560101	KM56-B 1M	1 m	biela
40560102	KM56-B 2M	2 m	biela
40560201	KM56-C 1M	1 m	čierna
40560202	KM56-C 2M	2 m	čierna

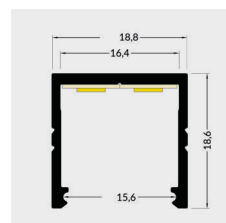

#### KRYT

obj. kód	typ	dĺžka	prevedenie
40131011	13-T 1M	1 m	nasúvací číry
40131012	13-T 2M	2 m	nasúvací číry
40131021	13-S 1M	1 m	nasúvací mrazený
40131022	13-S 2M	2 m	nasúvací mrazený
40131031	13-M 1M	1 m	nasúvací matný
40131032	13-M 2M	2 m	nasúvací matný
40561041	56-TK 1M	1 m	klik číry
40561042	56-TK 2M	2 m	klik číry
40561051	56-MK 1M	1 m	klik matný
40561052	56-MK 2M	2 m	klik matný

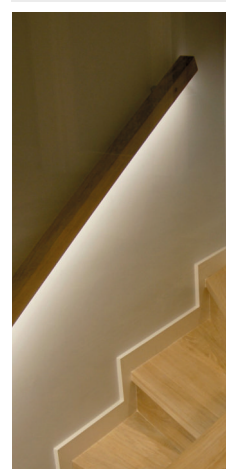

#### PRÍSLUŠENSTVO

obj. kód	typ	príslušenstvo
40562000	KM56K-S	koncovka strieborná
40562001	KM56K-B	koncovka biela
40562002	KM56K-C	koncovka čierna
40563000	KM56P-S	príchytky strieborná
40563001	KM56P-B	príchytky biela
40563002	KM56P-C	príchytky čierna



# ALU profily LED

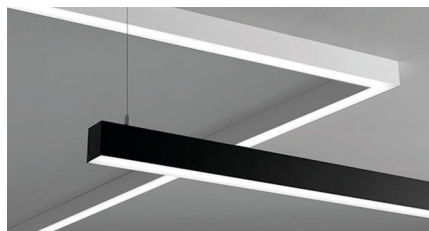
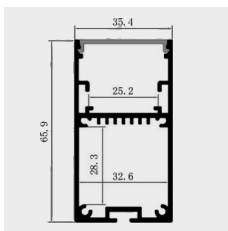

## LIŠTA

obj. kód	typ	dĺžka	farba
40900001	KM90-S 1M	1 m	strieborná
40900002	KM90-S 2M	2 m	strieborná
40900101	KM90-B 1M	1 m	biela
40900102	KM90-B 2M	2 m	biela
40900201	KM90-C 1M	1 m	čierna
40900202	KM90-C 2M	2 m	čierna

## KRYT

obj. kód	typ	dĺžka	prevedenie
40901051	90-MK 1M	1 m	klik matný
40901052	90-MK 2M	2 m	klik matný

## PRÍSLUŠENSTVO

obj. kód	typ	príslušenstvo
40902000	KM90K-S	koncovka strieborná
40902002	KM90K-B	koncovka biela
40902004	KM90K-C	koncovka čierna
40903001	KM90P-S	príchytky
40904000	KM90Z-S	záves strieborný

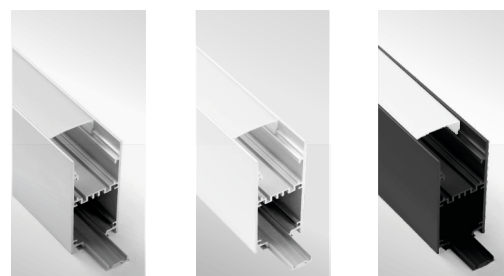

KM90-S

KM90-B

KM90-C



90-MK



KM90K-S  
KM90K-B  
KM90K-C

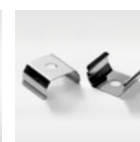

KM90P-S



KM90Z-S

**KM90**  
na povrch,  
na zavesenie

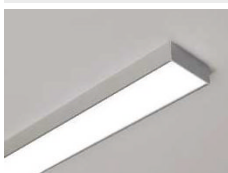
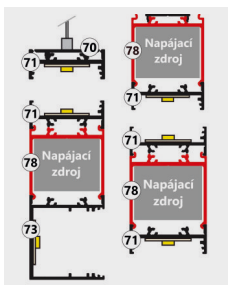
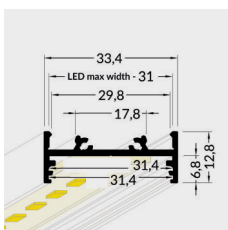

## LIŠTA

obj. kód	typ	dĺžka	farba
40710001	KM71-S 1M	1 m	strieborná
40710002	KM71-S 2M	2 m	strieborná
40710101	KM71-B 1M	1 m	biela
40710102	KM71-B 2M	2 m	biela
40710201	KM71-C 1M	1 m	čierna
40710202	KM71-C 2M	2 m	čierna

## KRYT

obj. kód	typ	dĺžka	prevedenie
40701011	70-T 1M	1 m	nasúvací číry
40701012	70-T 2M	2 m	nasúvací číry
40701021	70-S 1M	1 m	nasúvací mrazený
40701022	70-S 2M	2 m	nasúvací mrazený
40701031	70-M 1M	1 m	nasúvací matný
40701032	70-M 2M	2 m	nasúvací matný
40701041	70-TK 1M	1 m	klik číry
40701042	70-TK 2M	2 m	klik číry
40701051	70-MK 1M	1 m	klik matný
40701052	70-MK 2M	2 m	klik matný
40701061	70-MK-S 1M	1 m	klik matný S
40701062	70-MK-S 2M	2 m	klik matný S
40701071	70-MK-D 1M	1 m	klik matný D
40701072	70-MK-D 2M	2 m	klik matný D

## PRÍSLUŠENSTVO

obj. kód	typ	príslušenstvo
40712000	KM71K-S	koncovka strieborná
40712001	KM71K-B	koncovka biela
40712002	KM71K-C	koncovka čierna
40702000	KM70KS	koncovka krytu S
40702001	KM70KD	koncovka krytu D
40703000	KM70P	príchytky
40703001	KM70PF	príchytky flexi
40703005	KM70PV	príchytky výklopná

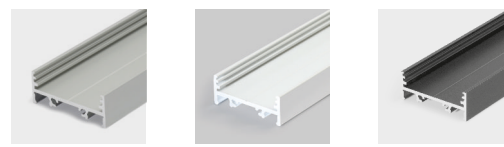

KM71-S

KM71-B

KM71-C

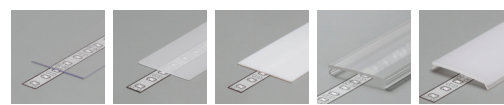

70-T

70-S

70-M

70-TK

70-MK

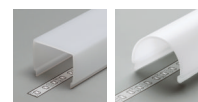

70-MK-S

70-MK-D

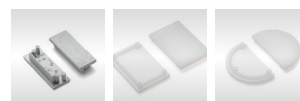

KM71K-S  
KM71K-B  
KM71K-C

KM70KS

KM70KD



KM70P

KM70PF

KM70PV

**KM71**  
**KOMBI**  
na povrch



## ALU profily LED

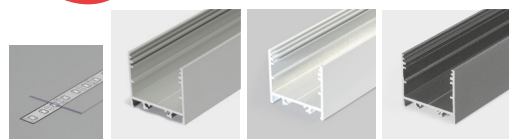

70-T KM72-S KM72-B KM72-C

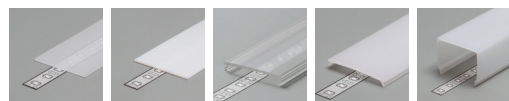

70-S 70-M 70-TK 70-MK 70-MK-S

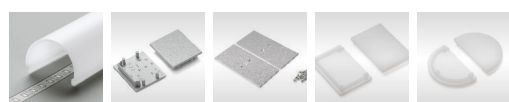

70-MK-D KM72K-S KM72K-38-S KM70KS KM70KD  
KM72K-B KM72K-38-B  
KM72K-C KM72K38-C

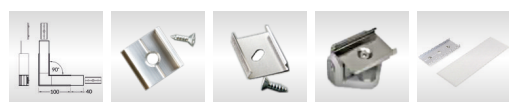

KM72R-90-S KM70P KM70PF KM70PV KM72S  
KM72R-90-B  
KM72R-90-C

### PRÍSLUŠENSTVO

obj. kód	typ	príslušenstvo
40703000	KM70P	príchytky
40703001	KM70PF	príchytky flexi
40703005	KM70PV	príchytky výklopná
40724000	KM72S	spojka
40725000	KM72R-90-S	roh 90° strieborný
40725001	KM72R-90-B	roh 90° biely
40725002	KM72R-90-C	roh 90° čierny

### KM72 KOMBI

na povrch

### LIŠTA

obj. kód	typ	dĺžka	farba
40720001	KM72-S 1M	1 m	strieborná
40720002	KM72-S 2M	2 m	strieborná
40720101	KM72-B 1M	1 m	biela
40720102	KM72-B 2M	2 m	biela
40720201	KM72-C 1M	1 m	čierna
40720202	KM72-C 2M	2 m	čierna

### KRYT

obj. kód	typ	dĺžka	prevedenie
40701011	70-T 1M	1 m	nasúvací číry
40701012	70-T 2M	2 m	nasúvací číry
40701021	70-S 1M	1 m	nasúvací mrazený
40701022	70-S 2M	2 m	nasúvací mrazený
40701031	70-M 1M	1 m	nasúvací matný
40701032	70-M 2M	2 m	nasúvací matný
40701041	70-TK 1M	1 m	klik číry
40701042	70-TK 2M	2 m	klik číry
40701051	70-MK 1M	1 m	klik matný
40701052	70-MK 2M	2 m	klik matný
40701061	70-MK-S 1M	1 m	klik matný S
40701062	70-MK-S 2M	2 m	klik matný S
40701071	70-MK-D 1M	1 m	klik matný D
40701072	70-MK-D 2M	2 m	klik matný D

### PRÍSLUŠENSTVO

obj. kód	typ	príslušenstvo
40722000	KM72K-S	koncovka strieborná
40722001	KM72K-B	koncovka biela
40722002	KM72K-C	koncovka čierna
40722005	KM72K-38-S	koncovka strieborná
40722006	KM72K-38-B	koncovka biela
40722007	KM72K-38-C	koncovka čierna
40702000	KM70KS	koncovka krytu S
40702001	KM70KD	koncovka krytu D

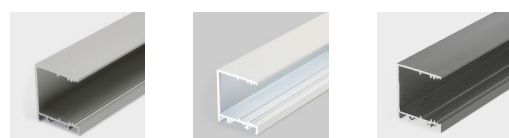
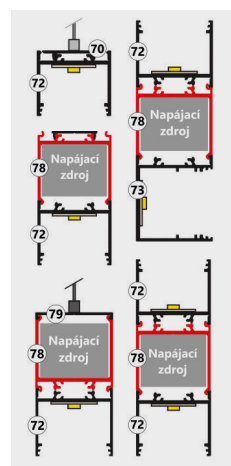
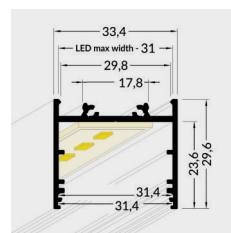

KM73-S KM73-B KM73-C

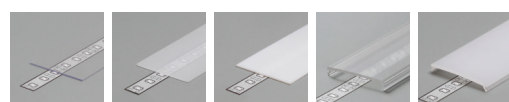

70-T 70-S 70-M 70-TK 70-MK

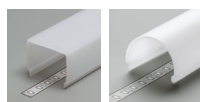

70-MK-S 70-MK-D



KM73K-S KM70KS KM70KD  
KM73K-B  
KM73K-C



KM70P KM70PF KM70PV

### KM73 KOMBI

na povrch

### LIŠTA

obj. kód	typ	dĺžka	farba
40730001	KM73-S 1M	1 m	strieborná
40730002	KM73-S 2M	2 m	strieborná
40730101	KM73-B 1M	1 m	biela
40730102	KM73-B 2M	2 m	biela
40730201	KM73-C 1M	1 m	čierna
40730202	KM73-C 2M	2 m	čierna

### KRYT

obj. kód	typ	dĺžka	prevedenie
40701011	70-T 1M	1 m	nasúvací číry
40701012	70-T 2M	2 m	nasúvací číry
40701021	70-S 1M	1 m	nasúvací mrazený
40701022	70-S 2M	2 m	nasúvací mrazený
40701031	70-M 1M	1 m	nasúvací matný
40701032	70-M 2M	2 m	nasúvací matný
40701041	70-TK 1M	1 m	klik číry
40701042	70-TK 2M	2 m	klik číry
40701051	70-MK 1M	1 m	klik matný
40701052	70-MK 2M	2 m	klik matný
40701061	70-MK-S 1M	1 m	klik matný S
40701062	70-MK-S 2M	2 m	klik matný S
40701071	70-MK-D 1M	1 m	klik matný D
40701072	70-MK-D 2M	2 m	klik matný D

### PRÍSLUŠENSTVO

obj. kód	typ	príslušenstvo
40732000	KM73K-S	koncovka strieborná
40732001	KM73K-B	koncovka biela
40732002	KM73K-C	koncovka čierna
40702000	KM70KS	koncovka krytu S
40702001	KM70KD	koncovka krytu D
40703000	KM70P	príchytky
40703001	KM70PF	príchytky flexi
40703005	KM70PV	príchytky výklopná

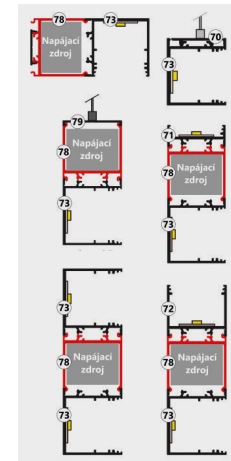
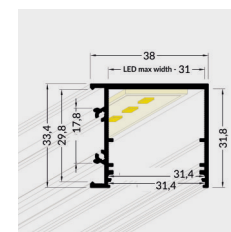

# ALU profily LED

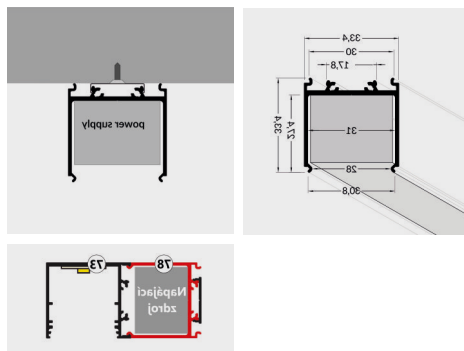
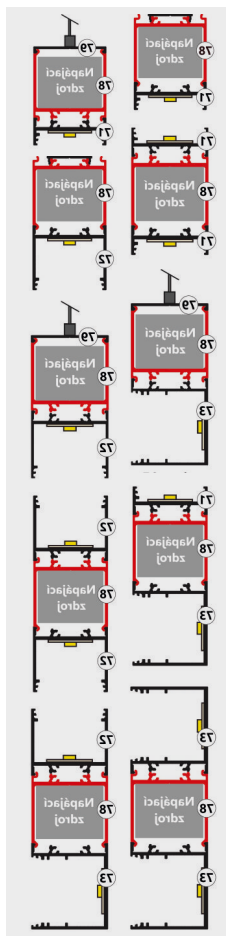

KM78-S

KM78-B

KM78-C

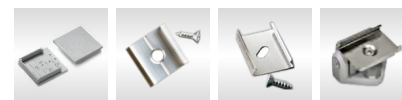

KM78K-S  
KM78K-B  
KM78K-C

KM70P

KM70PF

KM70PV

## LIŠTA

obj. kód	typ	dĺžka	farba
40780001	KM78-S 1M	1 m	strieborná
40780002	KM78-S 2M	2 m	strieborná
40780101	KM78-B 1M	1 m	biela
40780102	KM78-B 2M	2 m	biela
40780201	KM78-C 1M	1 m	čierna
40780202	KM78-C 2M	2 m	čierna

## PRÍSLUŠENSTVO

obj. kód	typ	príslušenstvo
40782000	KM78K-S	koncovka strieborná
40782001	KM78K-B	koncovka biela
40782002	KM78K-C	koncovka čierna
40703000	KM70P	príchytká
40703001	KM70PF	príchytká flexi
40703005	KM70PV	príchytká výklopná
40707000	KM70Z	záves

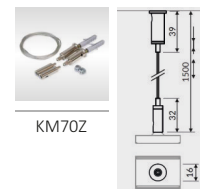

KM70Z

**KM78  
KOMBI**  
pre napájací zdroj

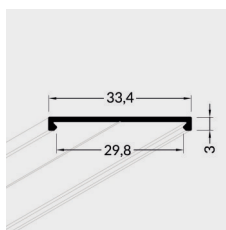

## LIŠTA

obj. kód	typ	dĺžka	farba
40790001	KM79-S 1M	1 m	strieborná
40790002	KM79-S 2M	2 m	strieborná
40790101	KM79-B 1M	1 m	biela
40790102	KM79-B 2M	2 m	biela
40790201	KM79-C 1M	1 m	čierna
40790202	KM79-C 2M	2 m	čierna



KM79-S

KM79-B

KM79-C

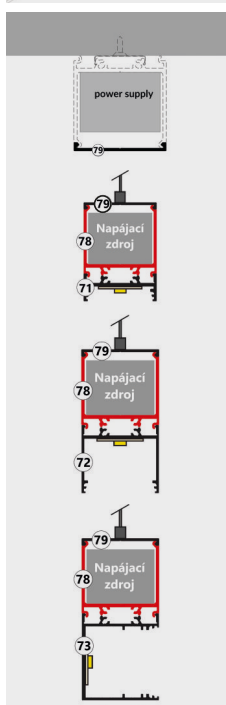

**KM79  
KOMBI**  
pomocný profil



## ALU profily LED



KM70-S

KM70-B

KM70-C

### LIŠTA

obj. kód	typ	dĺžka	farba
40700001	KM70-S 1M	1 m	strieborná
40700002	KM70-S 2M	2 m	strieborná
40700101	KM70-B 1M	1 m	biela
40700102	KM70-B 2M	2 m	biela
40700201	KM70-C 1M	1 m	čierna
40700202	KM70-C 2M	2 m	čierna

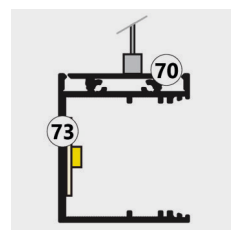
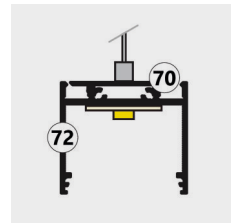
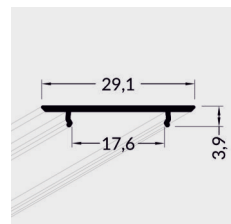

### KM70 KOMBI

pomocný profil

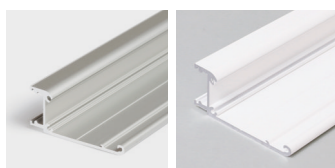

KM7-S

KM7-B

### LIŠTA

obj. kód	typ	dĺžka	farba
40070001	KM7-S 1M	1 m	strieborná
40070002	KM7-S 2M	2 m	strieborná
40070101	KM7-B 1M	1 m	biela
40070102	KM7-B 2M	2 m	biela

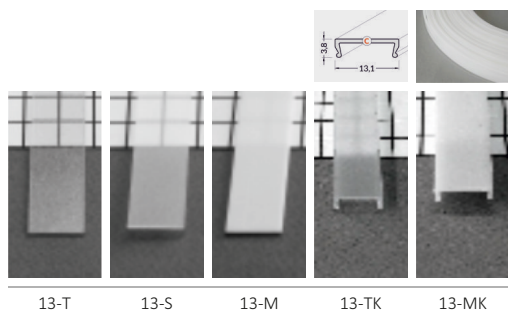
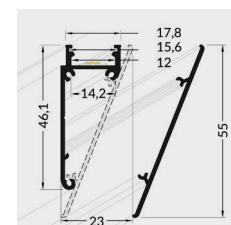

13-T

13-S

13-M

13-TK

13-MK

### KRYT

obj. kód	typ	dĺžka	prevedenie
40131011	13-T 1M	1 m	nasúvací číry
40131012	13-T 2M	2 m	nasúvací číry
40131021	13-S 1M	1 m	nasúvací mrazený
40131022	13-S 2M	2 m	nasúvací mrazený
40131031	13-M 1M	1 m	nasúvací matný
40131032	13-M 2M	2 m	nasúvací matný
40131041	13-TK 1M	1 m	klik číry
40131042	13-TK 2M	2 m	klik číry
40131051	13-MK 1M	1 m	klik matný
40131052	13-MK 2M	2 m	klik matný
40131053	13-MK 20M	20 m	klik matný

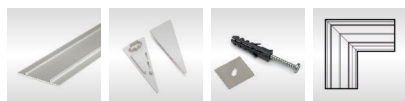

7-SK  
7-BK

KM7K-S  
KM7K-B

KM7S

KM7R-S  
KM7R-B

### PRÍSLUŠENSTVO

obj. kód	typ	príslušenstvo
40071061	7-SK 1M	kryt strieborný
40071062	7-SK 2M	kryt strieborný
40071063	7-BK 1M	kryt biely
40071064	7-BK 2M	kryt biely
40072000	KM7K-S	koncovka strieborná
40072001	KM7K-B	koncovka biela
40074000	KM7S	spojka
40075000	KM7R-S	roh strieborný
40075001	KM7R-B	roh biely



### KM7

nástenný profil

# ALU profily LED



KM10-S

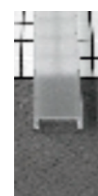
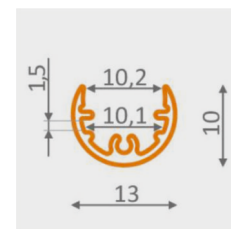

10-TK

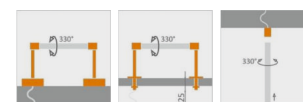

KM10POP

KM10POZ

KM10PK

## LIŠTA

obj. kód	typ	dĺžka	farba
40100001	KM10-S 1M	1 m	strieborná
40100002	KM10-S 2M	2 m	strieborná

## KRYT

obj. kód	typ	dĺžka	prevedenie
40101041	10-TK 1M	1 m	klik číry
40101042	10-TK 2M	2 m	klik číry

## PRÍSLUŠENSTVO

obj. kód	typ	príslušenstvo
40102000	KM10K	koncovka
40103000	KM10P	príchytká
40103010	KM10PK	príchytká koncová
40103020	KM10PR	príchytká rozperná
40103030	KM10PKP	príchytká kĺbová prisadená
40103040	KM10PKZ	príchytká kĺbová zapustená
40103051	KM10POP	príchytká odsadená prisadená
40103061	KM10POZ	príchytká odsadená zapustená

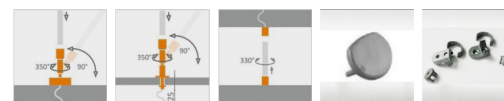

KM10PKP

KM10PKZ

KM10PR

KM10K

KM10P

## KM10

na povrch  
na odsadenie

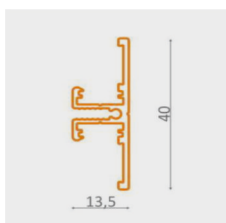

## LIŠTA

obj. kód	typ	dĺžka	farba
40400001	KM40-S 1M	1 m	strieborná
40400002	KM40-S 2M	2 m	strieborná
40400101	KM40-B 1M	1 m	biela
40400102	KM40-B 2M	2 m	biela
40400201	KM40-C 1M	1 m	čierna
40400202	KM40-C 2M	2 m	čierna

## KRYT

obj. kód	typ	dĺžka	prevedenie
40121011	12-T 1M	1 m	nasúvací číry
40121012	12-T 2M	2 m	nasúvací číry
40121021	12-S 1M	1 m	nasúvací mrazený
40121022	12-S 2M	2 m	nasúvací mrazený
40121031	12-M 1M	1 m	nasúvací matný
40121032	12-M 2M	2 m	nasúvací matný

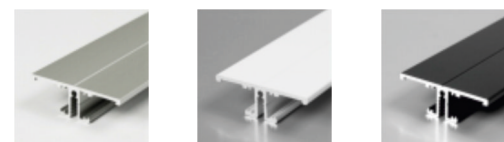

KM40-S

KM40-B

KM40-C

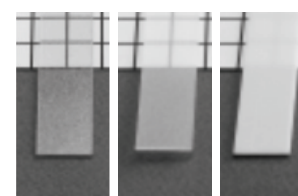

12-T

12-S

12-M

## PRÍSLUŠENSTVO

obj. kód	typ	príslušenstvo
40402000	KM40K-S	koncovka strieborná
40402001	KM40K-B	koncovka biela
40402002	KM40K-C	koncovka čierna
40133000	KM13P	príchytká
40133001	KM13PF	príchytká flexi
40134000	KM13S	spojka



KM40K

KM13P

KM13PF

KM13S

## KM40

na povrch  
nepriame osvetlenie

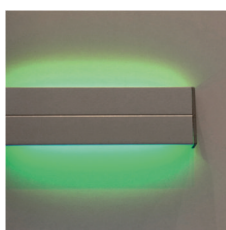
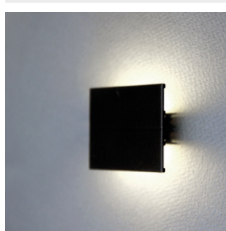



## ALU profily LED

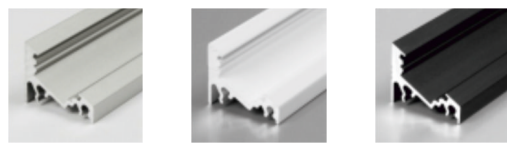

KM18-S

KM18-B

KM18-C

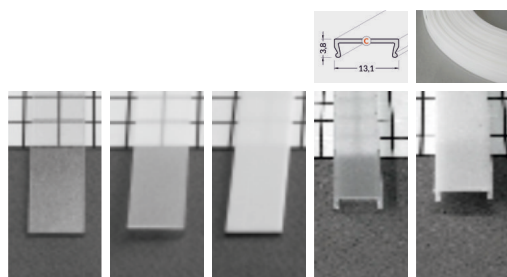

13-T

13-S

13-M

13-TK

13-MK



KM18K-S  
KM18K-B  
KM18K-C

KM13P

KM13PF

KM13S

KM18R-S  
KM18R-B  
KM18R-C

### KM18

rohový profil

#### LIŠTA

obj. kód	typ	dĺžka	farba
40180001	KM18-S 1M	1 m	strieborná
40180002	KM18-S 2M	2 m	strieborná
40180101	KM18-B 1M	1 m	biela
40180102	KM18-B 2M	2 m	biela
40180201	KM18-C 1M	1 m	čierna
40180202	KM18-C 2M	2 m	čierna

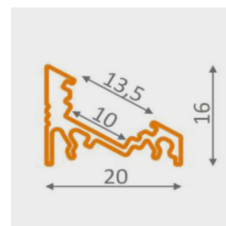

#### KRYT

obj. kód	typ	dĺžka	prevedenie
40131011	13-T 1M	1 m	nasúvací číry
40131012	13-T 2M	2 m	nasúvací číry
40131021	13-S 1M	1 m	nasúvací mrazený
40131022	13-S 2M	2 m	nasúvací mrazený
40131031	13-M 1M	1 m	nasúvací matný
40131032	13-M 2M	2 m	nasúvací matný
40131041	13-TK 1M	1 m	klik číry
40131042	13-TK 2M	2 m	klik číry
40131051	13-MK 1M	1 m	klik matný
40131052	13-MK 2M	2 m	klik matný
40131053	13-MK 20M	20 m	klik matný

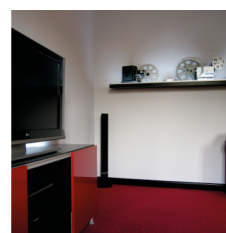
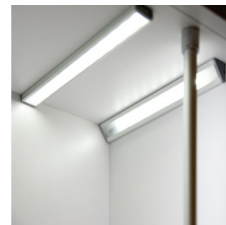

#### PRÍSLUŠENSTVO

obj. kód	typ	príslušenstvo
40182000	KM18K-S	koncovka strieborná
40182001	KM18K-B	koncovka biela
40182002	KM18K-C	koncovka čierna
40133000	KM13P	príchytká
40133001	KM13PF	príchytká flexi
40134000	KM13S	spojka
40185000	KM18R-S	roh strieborný
40185001	KM18R-B	roh biely
40185002	KM18R-C	roh čierny

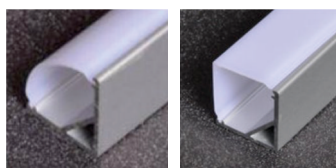
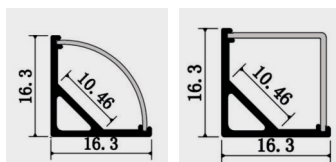

KM55-S

KM55-S



55-TK

55-MK

55-MK-S

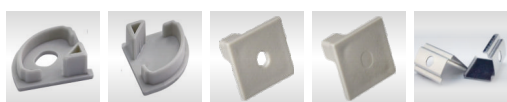

KM55K-S-O

KM55K-S

KM55K-S-S-O

KM55K-S-S

KM55P-S

### KM55

rohová

#### LIŠTA

obj. kód	typ	dĺžka	farba
40550001	KM55-S 1M	1 m	strieborná
40550002	KM55-S 2M	2 m	strieborná

#### KRYT

obj. kód	typ	dĺžka	prevedenie
40551041	55-TK 1M	1 m	klik číry
40551042	55-TK 2M	2 m	klik číry
40551051	55-MK 1M	1 m	klik matný
40551052	55-MK 2M	2 m	klik matný
40551071	55-MK-S 1M	1 m	klik matný štvorcový
40551072	55-MK-S 2M	2 m	klik matný štvorcový

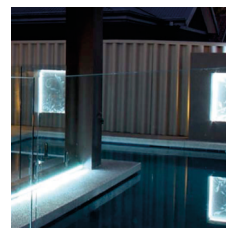
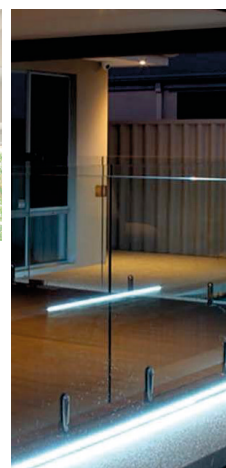

#### PRÍSLUŠENSTVO

obj. kód	typ	príslušenstvo
40552000	KM55K-S	koncovka strieborná
40552001	KM55K-S-O	koncovka strieb. s otvorom
40552002	KM55K-S-S	koncovka štvorcová strieb.
40552003	KM55K-S-S-O	koncovka štvorcová strieb. s otvorom
40553001	KM55P-S	príchytká

# ALU profily LED

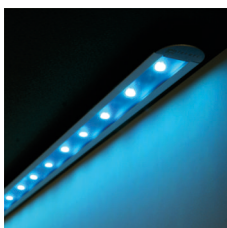
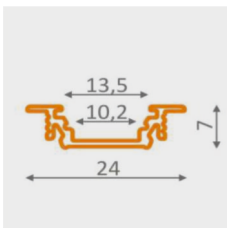

## LIŠTA

obj. kód	typ	dĺžka	farba
40150001	KM15-S 1M	1 m	strieborná
40150002	KM15-S 2M	2 m	strieborná
40150101	KM15-B 1M	1 m	biela
40150102	KM15-B 2M	2 m	biela
40150201	KM15-C 1M	1 m	čierna
40150202	KM15-C 2M	2 m	čierna

## KRYT

obj. kód	typ	dĺžka	prevedenie
40131011	13-T 1M	1 m	nasúvací číry
40131012	13-T 2M	2 m	nasúvací číry
40131021	13-S 1M	1 m	nasúvací mrazený
40131022	13-S 2M	2 m	nasúvací mrazený
40131031	13-M 1M	1 m	nasúvací matný
40131032	13-M 2M	2 m	nasúvací matný
40131041	13-TK 1M	1 m	klik číry
40131042	13-TK 2M	2 m	klik číry
40131051	13-MK 1M	1 m	klik matný
40131052	13-MK 2M	2 m	klik matný
40131053	13-MK 20M	20 m	klik matný

## PRÍSLUŠENSTVO

obj. kód	typ	príslušenstvo
40152000	KM15K-S	koncovka strieborná
40152001	KM15K-B	koncovka biela
40152002	KM15K-C	koncovka čierna
40133000	KM13P	príchytká
40133001	KM13PF	príchytká flexi
40134000	KM13S	spojka
40155000	KM15R-S	roh strieborný
40155001	KM15R-B	roh biely
40155002	KM15R-C	roh čierny

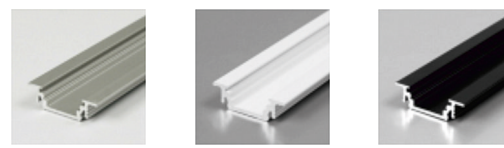

KM15-S

KM15-B

KM15-C

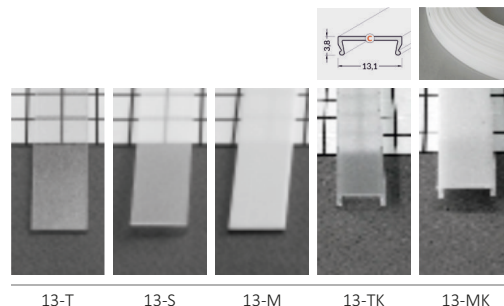

13-T

13-S

13-M

13-TK

13-MK

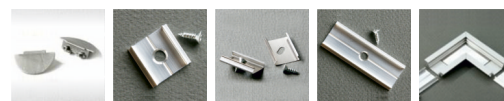

KM15K-S  
KM15K-B  
KM15K-C

KM13P

KM13PF

KM13S

KM15R-S  
KM15R-B  
KM15R-C

## KM15

na zapuzenie

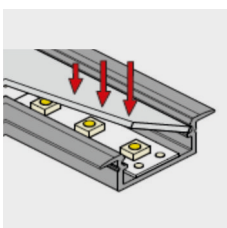
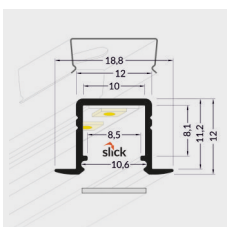

## LIŠTA

obj. kód	typ	dĺžka	farba
40490001	KM49-S 1M	1 m	strieborná
40490002	KM49-S 2M	2 m	strieborná
40490101	KM49-B 1M	1 m	biela
40490102	KM49-B 2M	2 m	biela
40490201	KM49-C 1M	1 m	čierna
40490202	KM49-C 2M	2 m	čierna

## KRYT

obj. kód	typ	dĺžka	prevedenie
40121011	12-T 1M	1 m	nasúvací číry
40121012	12-T 2M	2 m	nasúvací číry
40121021	12-S 1M	1 m	nasúvací mrazený
40121022	12-S 2M	2 m	nasúvací mrazený
40121031	12-M 1M	1 m	nasúvací matný
40121032	12-M 2M	2 m	nasúvací matný
40121041	12-TK 1m	1 m	klik číry
40121042	12-TK 2m	2 m	klik číry
40121051	12-MK 1m	1 m	klik matný
40121052	12-MK 2m	2 m	klik matný
40121053	12-MK 20m	20 m	klik matný

## PRÍSLUŠENSTVO

obj. kód	typ	príslušenstvo
40492000	KM49K-S	koncovka strieborná
40492001	KM49K-B	koncovka biela
40492002	KM49K-C	koncovka čierna

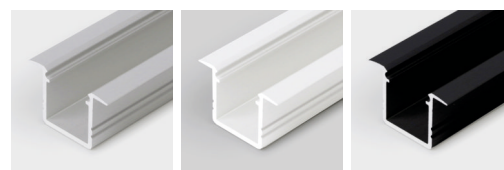

KM49-S

KM49-B

KM49-C

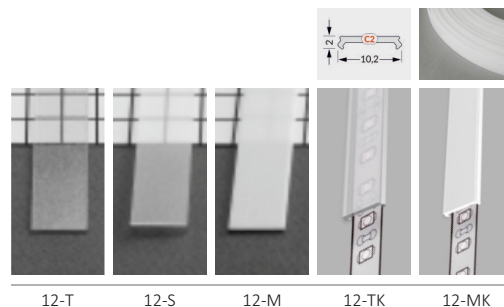

12-T

12-S

12-M

12-TK

12-MK

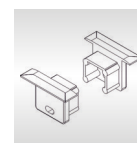

KM49K-S  
KM49K-B  
KM49K-C

## KM49

na zapuzenie



## ALU profily LED



KM29-S

KM29-B

KM29-C

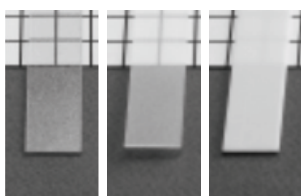

26-T

26-S

26-M



KM29K-S  
KM29K-B  
KM29K-C

### KM29

na zapustenie

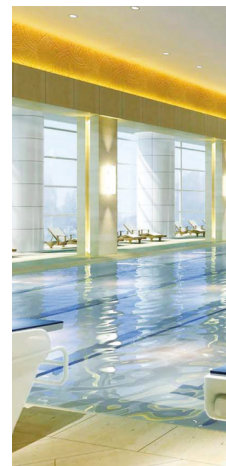
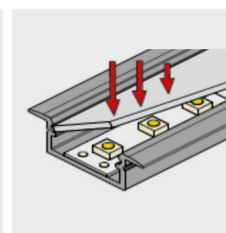
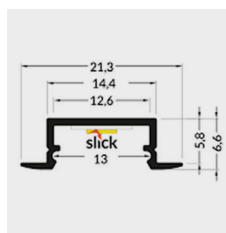

#### LIŠTA

obj. kód	typ	dĺžka	farba
40290001	KM29-S 1M	1 m	strieborná
40290002	KM29-S 2M	2 m	strieborná
40290101	KM29-B 1M	1 m	biela
40290102	KM29-B 2M	2 m	biela
40290201	KM29-C 1M	1 m	čierna
40290202	KM29-C 2M	2 m	čierna

#### KRYT

obj. kód	typ	dĺžka	prevedenie
40261011	26-T 1M	1 m	slick číry
40261012	26-T 2M	2 m	slick číry
40261021	26-S 1M	1 m	slick mrazený
40261022	26-S 2M	2 m	slick mrazený
40261031	26-M 1M	1 m	slick matný
40261032	26-M 2M	2 m	slick matný

#### PRÍSLUŠENSTVO

obj. kód	typ	príslušenstvo
40292000	KM29K-S	koncovka strieborná
40292001	KM29K-B	koncovka biela
40292002	KM29K-C	koncovka čierna

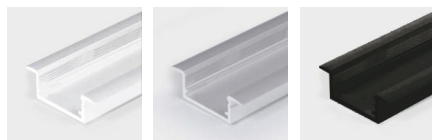

KM39-S

KM39-B

KM39-C

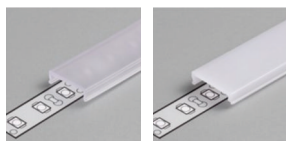

36-TK

36-MK

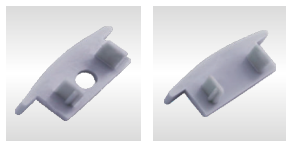

KM39K-S-O  
KM39K-B-O  
KM39K-C-O

KM39K-S  
KM39K-B  
KM39K-C

### KM39

na zapustenie

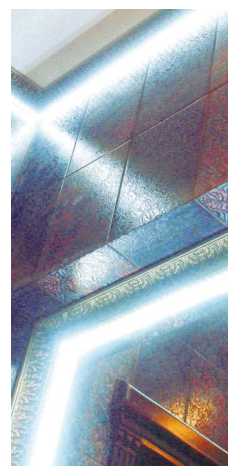
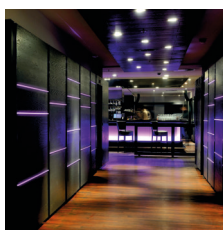
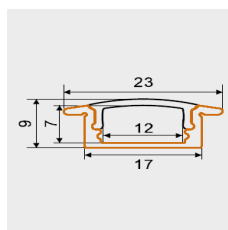

#### LIŠTA

obj. kód	typ	dĺžka	farba
40390001	KM39-S 1M	1 m	strieborná
40390002	KM39-S 2M	2 m	strieborná
40390101	KM39-B 1M	1 m	biela
40390102	KM39-B 2M	2 m	biela
40390201	KM39-C 1M	1 m	čierna
40390202	KM39-C 2M	2 m	čierna

#### KRYT

obj. kód	typ	dĺžka	prevedenie
40361041	36-TK 1M	1 m	klik číry
40361042	36-TK 2M	2 m	klik číry
40361051	36-MK 1M	1 m	klik matný
40361052	36-MK 2M	2 m	klik matný

#### PRÍSLUŠENSTVO

obj. kód	typ	príslušenstvo
40392000	KM39K-S	koncovka strieborná
40392001	KM39K-S-O	koncovka s otvorom strieborná
40392002	KM39K-B	koncovka biela
40392003	KM39K-B-O	koncovka s otvorom biela
40392004	KM39K-C	koncovka čierna
40392005	KM39K-C-O	koncovka s otvorom čierna



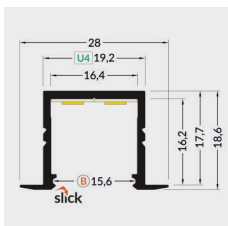

## LIŠŤA

obj. kód	typ	dĺžka	farba
40590001	KM59-S 1M	1 m	strieborná
40590002	KM59-S 2M	2 m	strieborná
40590101	KM59-B 1M	1 m	biela
40590102	KM59-B 2M	2 m	biela

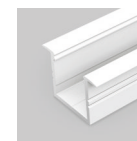
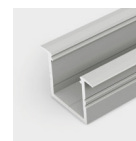

KM59-S

KM59-B

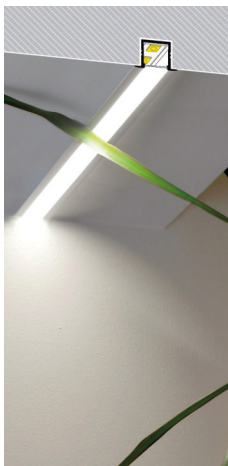

## KRYT

obj. kód	typ	dĺžka	prevedenie
40131011	13-T 1M	1 m	nasúvací číry
40131012	13-T 2M	2 m	nasúvací číry
40131021	13-S 1M	1 m	nasúvací mrazený
40131022	13-S 2M	2 m	nasúvací mrazený
40131031	13-M 1M	1 m	nasúvací matný
40131032	13-M 2M	2 m	nasúvací matný
40561041	56-TK 1M	1 m	klik číry
40561042	56-TK 2M	2 m	klik číry
40561051	56-MK 1M	1 m	klik matný
40561052	56-MK 2M	2 m	klik matný

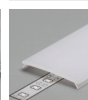
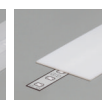
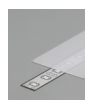
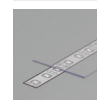

13-T

13-S

13-M

56-TK

56-MK

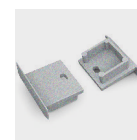

KM59K-S  
KM59K-B

KM56P-S  
KM56P-B

KM59P-S

## PRÍSLUŠENSTVO

obj. kód	typ	príslušenstvo
40592000	KM59K-S	koncovka strieborná
40592001	KM59K-B	koncovka biela
40563000	KM56P-S	príchytká strieborná
40563001	KM56P-B	príchytká biela
40593000	KM59P-S	príchytká strieborná

## KM59

na zapustenie

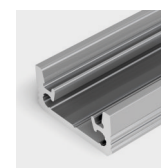
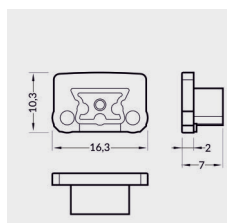
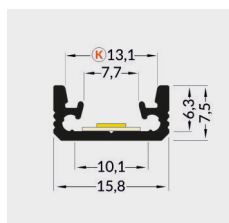
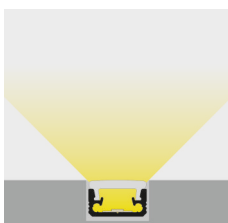

KM30-S

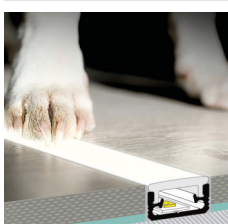

## LIŠŤA

obj. kód	typ	dĺžka	farba
40300001	KM30-S 1M	1 m	strieborná
40300002	KM30-S 2M	2 m	strieborná

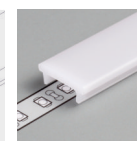
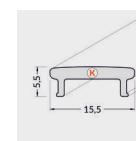

30-MK



## KRYT

obj. kód	typ	dĺžka	prevedenie
40301051	30-MK 1M	1 m	klik matný
40301052	30-MK 2M	2 m	klik matný

## PRÍSLUŠENSTVO

obj. kód	typ	príslušenstvo
40302000	KM30K-S	koncovka strieborná
40305000	KM30T	tesniaca sada

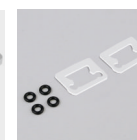

KM30K-S

KM30T

## KM30

na zapustenie  
do podlahy



## ALU profily LED

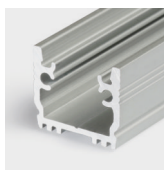

KM31-S

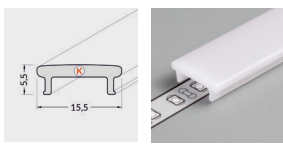
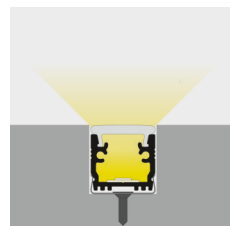
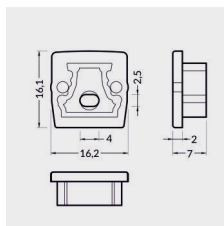
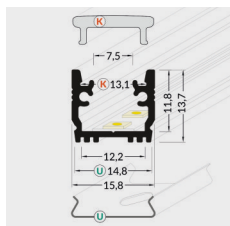

30-MK



KM31K-S

KM31K-S-O

KM31T

### LIŠTA

obj. kód	typ	dĺžka	farba
40310001	KM31-S 1M	1 m	strieborná
40310002	KM31-S 2M	2 m	strieborná

### KRYT

obj. kód	typ	dĺžka	prevedenie
40301051	30-MK 1M	1 m	klik matný
40301052	30-MK 2M	2 m	klik matný

### PRÍSLUŠENSTVO

obj. kód	typ	príslušenstvo
40312000	KM31K-S	koncovka strieborná
40312001	KM31K-S-O	koncovka s otvorom
40315000	KM31T	tesniaca sada



## KM31

na zapustenie  
do podlahy

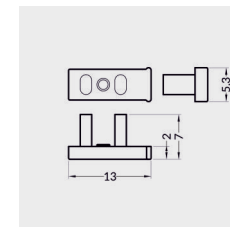
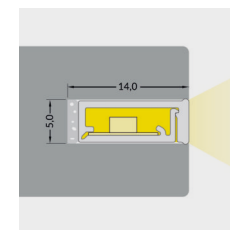
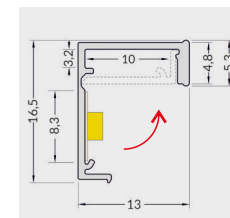

## KM20

na zapustenie



KM20K-O

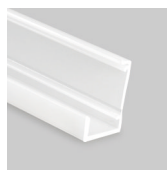

KM20-O

### LIŠTA

obj. kód	typ	dĺžka	farba
40200001	KM20-O 1M	1 m	opál
40200002	KM20-O 2M	2 m	opál

### PRÍSLUŠENSTVO

obj. kód	typ	príslušenstvo
40202000	KM20K-O	koncovka opálová

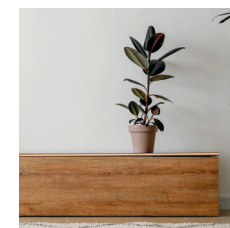

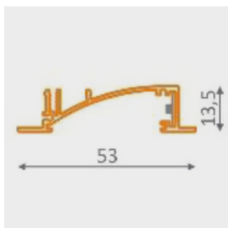

## LIŠTA

obj. kód	typ	dĺžka	farba
40500001	KM50-S 1M	1 m	strieborná
40500002	KM50-S 2M	2 m	strieborná
40500101	KM50-B 1M	1 m	biela
40500102	KM50-B 2M	2 m	biela
40500201	KM50-C 1M	1 m	čierna
40500202	KM50-C 2M	2 m	čierna

## KRYT

obj. kód	typ	dĺžka	prevedenie
40501011	50-T 1M	1 m	nasúvací číry
40501012	50-T 2M	2 m	nasúvací číry
40501031	50-M 1M	1 m	nasúvací matný
40501032	50-M 2M	2 m	nasúvací matný

## PRÍSLUŠENSTVO

obj. kód	typ	príslušenstvo
40502000	KM50K-S	koncovka strieborná
40502001	KM50K-B	koncovka biela
40502002	KM50K-C	koncovka čierna
40133000	KM13P	príchytká
40133001	KM13PF	príchytká flexi
40134000	KM13S	spojka
40136000	KM13U	úchyt

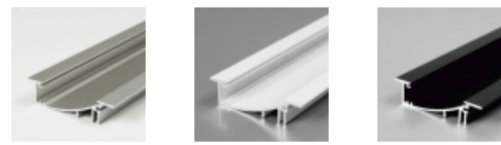

KM50-S

KM50-B

KM50-C

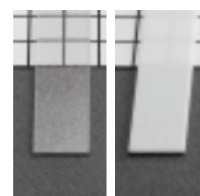

50-T

50-M



KM50K-S  
KM50K-B  
KM50K-C

KM13P

KM13PF

KM13S

KM13U

## KM50

na zapustenie  
nepriame osvetlenie

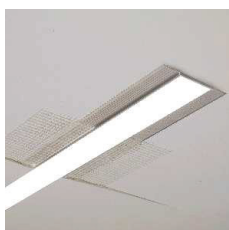
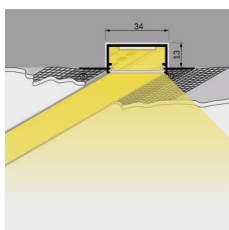
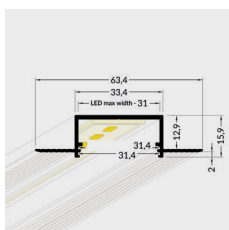

## LIŠTA

obj. kód	typ	dĺžka	farba
40740001	KM74-S 1M	1 m	strieborná
40740002	KM74-S 2M	2 m	strieborná
40740101	KM74-B 1M	1 m	biela
40740102	KM74-B 2M	2 m	biela

## KRYT

obj. kód	typ	dĺžka	prevedenie
40701011	70-T 1M	1 m	nasúvací číry
40701012	70-T 2M	2 m	nasúvací číry
40701021	70-S 1M	1 m	nasúvací mrazený
40701022	70-S 2M	2 m	nasúvací mrazený
40701031	70-M 1M	1 m	nasúvací matný
40701032	70-M 2M	2 m	nasúvací matný
40701041	70-TK 1M	1 m	klik číry
40701042	70-TK 2M	2 m	klik číry
40701051	70-MK 1M	1 m	klik matný
40701052	70-MK 2M	2 m	klik matný
40701061	70-MK-S 1M	1 m	klik matný S
40701062	70-MK-S 2M	2 m	klik matný S
40701071	70-MK-D 1M	1 m	klik matný D
40701072	70-MK-D 2M	2 m	klik matný D

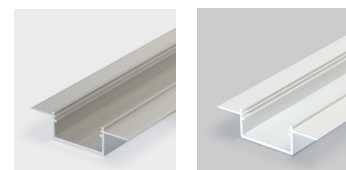

KM74-S

KM74-B

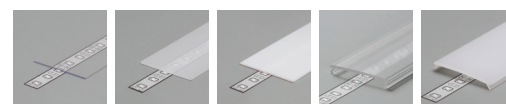

70-T

70-S

70-M

70-TK

70-MK

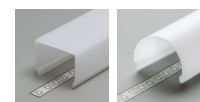

70-MK-S

70-MK-D

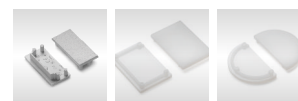

KM74K-S  
KM74K-B

KM70KS

KM70KD

## PRÍSLUŠENSTVO

obj. kód	typ	príslušenstvo
40742000	KM74K-S	koncovka strieborná
40742001	KM74K-B	koncovka biela
40702000	KM70KS	koncovka krytu S
40702001	KM70KD	koncovka krytu D

## KM74

## KOMBI

na zapustenie



## ALU profily LED

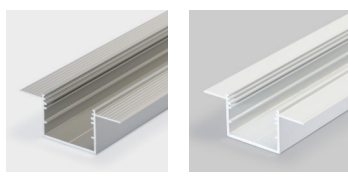

KM75-S

KM75-B

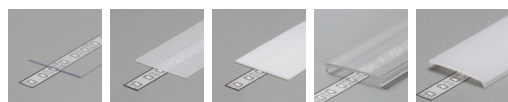

70-T

70-S

70-M

70-TK

70-MK

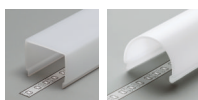

70-MK-S

70-MK-D



KM75K-S  
KM75K-B

KM70KS

KM70KD

KM75R-90-S  
KM75R-90-B

### KM75 KOMBI

na zapustenie

#### LIŠTA

obj. kód	typ	dĺžka	farba
40750001	KM75-S 1M	1 m	strieborná
40750002	KM75-S 2M	2 m	strieborná
40750101	KM75-B 1M	1 m	biela
40750102	KM75-B 2M	2 m	biela

#### KRYT

obj. kód	typ	dĺžka	prevedenie
40701011	70-T 1M	1 m	nasúvací číry
40701012	70-T 2M	2 m	nasúvací číry
40701021	70-S 1M	1 m	nasúvací mrazený
40701022	70-S 2M	2 m	nasúvací mrazený
40701031	70-M 1M	1 m	nasúvací matný
40701032	70-M 2M	2 m	nasúvací matný
40701041	70-TK 1M	1 m	klik číry
40701042	70-TK 2M	2 m	klik číry
40701051	70-MK 1M	1 m	klik matný
40701052	70-MK 2M	2 m	klik matný
40701061	70-MK-S 1M	1 m	klik matný S
40701062	70-MK-S 2M	2 m	klik matný S
40701071	70-MK-D 1M	1 m	klik matný D
40701072	70-MK-D 2M	2 m	klik matný D

#### PRÍSLUŠENSTVO

obj. kód	typ	príslušenstvo
40752000	KM75K-S	koncovka strieborná
40752001	KM75K-B	koncovka biela
40702000	KM70KS	koncovka krytu S
40702001	KM70KD	koncovka krytu D
40755000	KM75R-90-S	roh 90° strieborný
40755001	KM75R-90-B	roh 90° biely

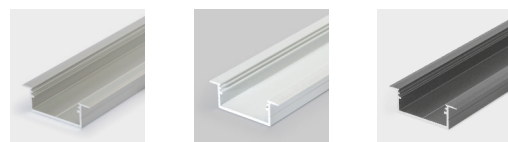
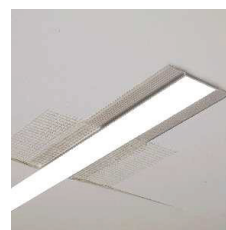
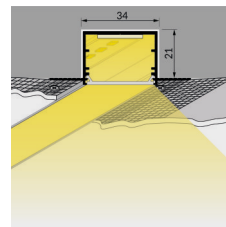
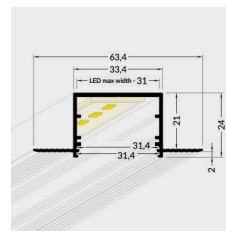

KM76-S

KM76-B

KM76-C

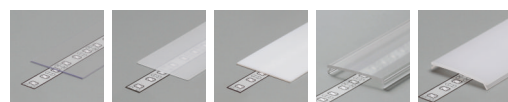

70-T

70-S

70-M

70-TK

70-MK

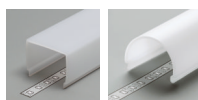

70-MK-S

70-MK-D



KM76K-S  
KM76K-B  
KM76K-C

KM70KS

KM70KD

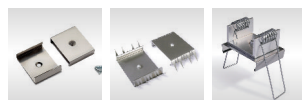

KM76PF

KM76PF-Z

KM76U

### KM76 KOMBI

na zapustenie

#### LIŠTA

obj. kód	typ	dĺžka	farba
40760001	KM76-S 1M	1 m	strieborná
40760002	KM76-S 2M	2 m	strieborná
40760101	KM76-B 1M	1 m	biela
40760102	KM76-B 2M	2 m	biela
40760201	KM76-C 1M	1 m	čierna
40760202	KM76-C 2M	2 m	čierna

#### KRYT

obj. kód	typ	dĺžka	prevedenie
40701011	70-T 1M	1 m	nasúvací číry
40701012	70-T 2M	2 m	nasúvací číry
40701021	70-S 1M	1 m	nasúvací mrazený
40701022	70-S 2M	2 m	nasúvací mrazený
40701031	70-M 1M	1 m	nasúvací matný
40701032	70-M 2M	2 m	nasúvací matný
40701041	70-TK 1M	1 m	klik číry
40701042	70-TK 2M	2 m	klik číry
40701051	70-MK 1M	1 m	klik matný
40701052	70-MK 2M	2 m	klik matný
40701061	70-MK-S 1M	1 m	klik matný S
40701062	70-MK-S 2M	2 m	klik matný S
40701071	70-MK-D 1M	1 m	klik matný D
40701072	70-MK-D 2M	2 m	klik matný D

#### PRÍSLUŠENSTVO

obj. kód	typ	príslušenstvo
40762000	KM76K-S	koncovka strieborná
40762001	KM76K-B	koncovka biela
40762002	KM76K-C	koncovka čierna
40702000	KM70KS	koncovka krytu S
40702001	KM70KD	koncovka krytu D
40763001	KM76PF	príchytky flexi
40763002	KM76PF-Z	príchytky flexi Z
40766000	KM76U	úchyt

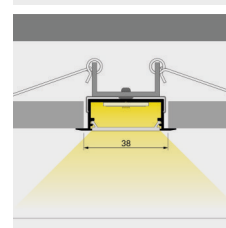
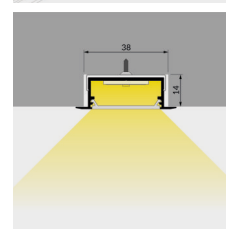
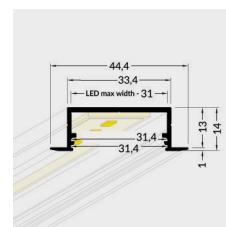

# ALU profily LED

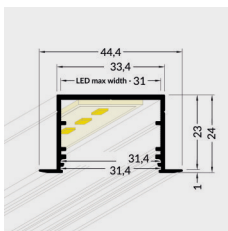

## LIŠTA

obj. kód	typ	dĺžka	farba
40770001	KM77-S 1M	1 m	strieborná
40770002	KM77-S 2M	2 m	strieborná
40770101	KM77-B 1M	1 m	biela
40770102	KM77-B 2M	2 m	biela
40770201	KM77-C 1M	1 m	čierna
40770202	KM77-C 2M	2 m	čierna

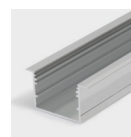

KM77-S

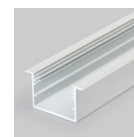

KM77-B

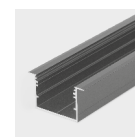

KM77-C

## KRYT

obj. kód	typ	dĺžka	prevedenie
40701011	70-T 1M	1 m	nasúvací číry
40701012	70-T 2M	2 m	nasúvací číry
40701021	70-S 1M	1 m	nasúvací mrazený
40701022	70-S 2M	2 m	nasúvací mrazený
40701031	70-M 1M	1 m	nasúvací matný
40701032	70-M 2M	2 m	nasúvací matný
40701041	70-TK 1M	1 m	klik číry
40701042	70-TK 2M	2 m	klik číry
40701051	70-MK 1M	1 m	klik matný
40701052	70-MK 2M	2 m	klik matný
40701061	70-MK-S 1M	1 m	klik matný S
40701062	70-MK-S 2M	2 m	klik matný S
40701071	70-MK-D 1M	1 m	klik matný D
40701072	70-MK-D 2M	2 m	klik matný D

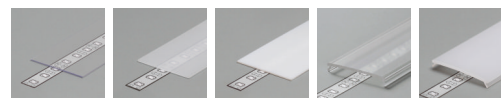

70-T

70-S

70-M

70-TK

70-MK

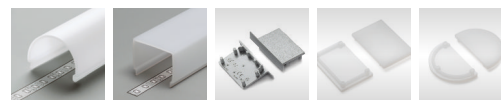

70-MK-D

70-MK-S

KM77K-S

KM70KS

KM70KD

KM77K-B

KM77K-C

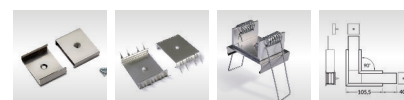

KM76PF

KM76PF-Z

KM76U

KM77R-90-S

KM77R-90-B

KM77R-90-C

## PRÍSLUŠENSTVO

obj. kód	typ	príslušenstvo
40772000	KM77K-S	koncovka strieborná
40772001	KM77K-B	koncovka biela
40772002	KM77K-C	koncovka čierna
40702000	KM70KS	koncovka krytu S
40702001	KM70KD	koncovka krytu D
40763001	KM76PF	príchytká flexi
40763002	KM76PF-Z	príchytká flexi Z

## PRÍSLUŠENSTVO

obj. kód	typ	príslušenstvo
40766000	KM76U	úchyt
40775000	KM77R-90-S	roh 90° strieborný
40775001	KM77R-90-B	roh 90° biely
40775002	KM77R-90-C	roh 90° čierny

**KM77  
KOMBI**  
na zapustenie

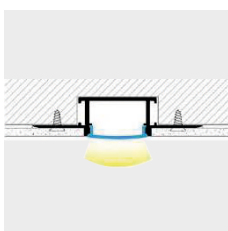
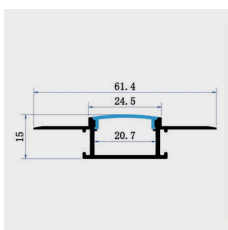
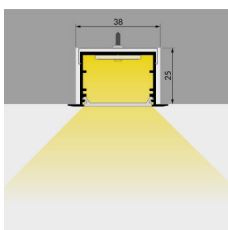
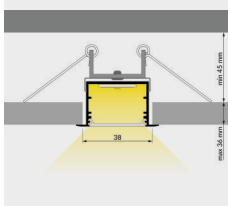

## LIŠTA

obj. kód	typ	dĺžka	farba
40810001	KM81-S 1M	1 m	strieborná
40810002	KM81-S 2M	2 m	strieborná
40810101	KM81-B 1M	1 m	biela
40810102	KM81-B 2M	2 m	biela
40810201	KM81-C 1M	1 m	čierna
40810202	KM81-C 2M	2 m	čierna

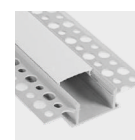

KM81-S



KM81-B



KM81-C

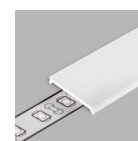

81-MK

## KRYT

obj. kód	typ	dĺžka	prevedenie
40811051	81-MK 1M	1 m	klik matný
40811052	81-MK 2M	2 m	klik matný



KM81K-S

KM81K-B

KM81K-C

KM81K-S-O

KM81K-B-O

KM81K-C-O

## PRÍSLUŠENSTVO

obj. kód	typ	príslušenstvo
40812000	KM81K-S	koncovka strieborná
40812001	KM81K-S-O	koncovka s otvorom strieborná
40812002	KM81K-B	koncovka biela
40812003	KM81K-B-O	koncovka s otvorom biela
40812004	KM81K-C	koncovka čierna
40812005	KM81K-C-O	koncovka s otvorom čierna

**KM81**  
do sadrokartónu



## ALU profily LED



KM85-S

KM85-B

KM85-C

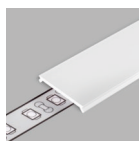

85-MK

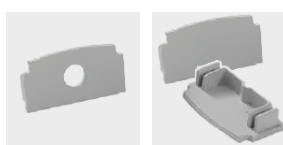

KM85K-S

KM85K-S-O

### LIŠTA

obj. kód	typ	dĺžka	farba
40850001	KM85-S 1M	1 m	strieborná
40850002	KM85-S 2M	2 m	strieborná
40850101	KM85-B 1M	1 m	biela
40850102	KM85-B 2M	2 m	biela
40850201	KM85-C 1M	1 m	čierna
40850202	KM85-C 2M	2 m	čierna

### KRYT

obj. kód	typ	dĺžka	prevedenie
40851051	85-MK 1M	1 m	klik matný
40851052	85-MK 2M	2 m	klik matný

### PRÍSLUŠENSTVO

obj. kód	typ	príslušenstvo
40852000	KM85K-S	koncovka strieborná
40852001	KM85K-S-O	koncovka s otvorom strieborná
40852002	KM85K-B	koncovka biela
40852003	KM85K-B-O	koncovka s otvorom biela
40852004	KM85K-C	koncovka čierna
40852005	KM85K-C-O	koncovka s otvorom čierna

## KM85

do sadrokartónu

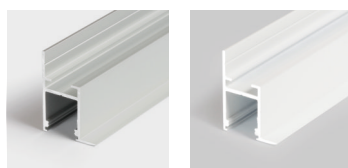
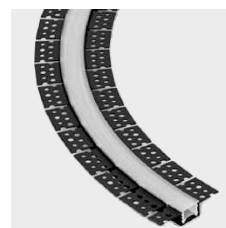
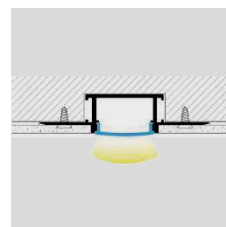
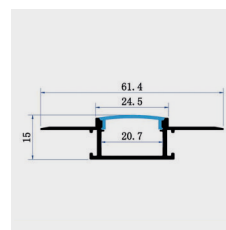

KM5-S

KM5-B

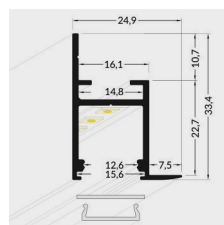

### LIŠTA

obj. kód	typ	dĺžka	farba
40050001	KM5-S 1M	1 m	strieborná
40050002	KM5-S 2M	2 m	strieborná
40050101	KM5-B 1M	1 m	biela
40050102	KM5-B 2M	2 m	biela

### KRYT

obj. kód	typ	dĺžka	prevedenie
40131011	13-T 1M	1 m	nasúvací číry
40131012	13-T 2M	2 m	nasúvací číry
40131021	13-S 1M	1 m	nasúvací mrazený
40131022	13-S 2M	2 m	nasúvací mrazený
40131031	13-M 1M	1 m	nasúvací matný
40131032	13-M 2M	2 m	nasúvací matný
40131041	13-TK 1M	1 m	klik číry
40131042	13-TK 2M	2 m	klik číry
40131051	13-MK 1M	1 m	klik matný
40131052	13-MK 2M	2 m	klik matný
40131053	13-MK 20M	20 m	klik matný

### PRÍSLUŠENSTVO

obj. kód	typ	príslušenstvo
40054000	KM5S-180	spojka 180°
40054001	KM5S-135	spojka 135°
40054002	KM5S-90	spojka 90°
40054003	KM5S-90Z	spojka/záves 90°

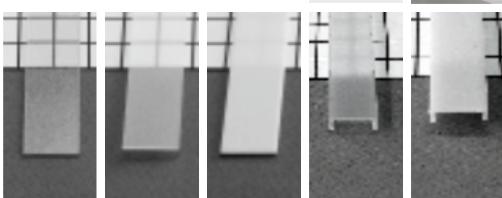

13-T

13-S

13-M

13-TK

13-MK

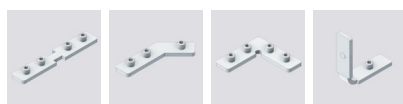

KM5S-180

KM5S-135

KM5S-90

KM5S-90Z

## KM5

k sadrokartónom

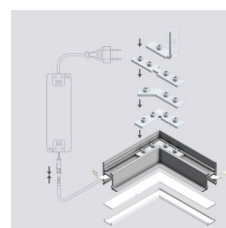
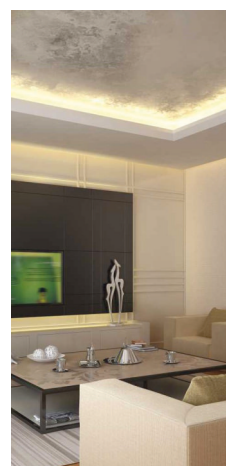

# ALU profily LED

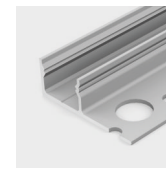
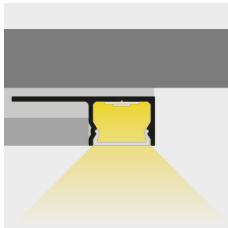
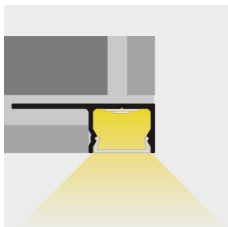
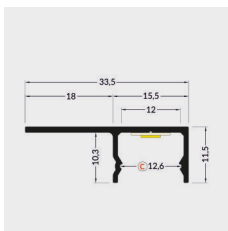

KM61-S

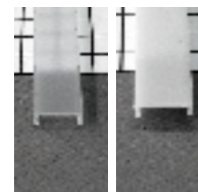

13-TK

13-MK



KM61K-S-O

KM61K-S

## LIŠTA

obj. kód	typ	dĺžka	farba
40610001	KM61-S 1M	1 m	strieborná
40610002	KM61-S 2M	2 m	strieborná

## KRYT

obj. kód	typ	dĺžka	prevedenie
40131041	13-TK 1M	1 m	klik číry
40131042	13-TK 2M	2 m	klik číry
40131051	13-MK 1M	1 m	klik matný
40131052	13-MK 2M	2 m	klik matný
40131053	13-MK 20M	20 m	klik matný

## PRÍSLUŠENSTVO

obj. kód	typ	príslušenstvo
40612000	KM61K-S	koncovka strieborná
40612001	KM61K-S-O	koncovka s otvorom strieborná

## KM61

k obkladom  
a dlažbám

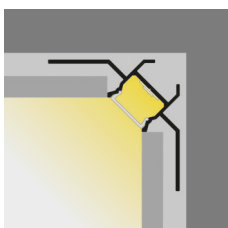
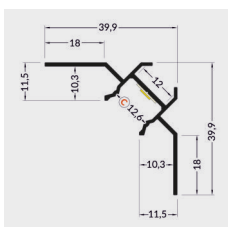

KM62-S

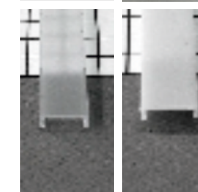

13-TK

13-MK



KM61K-S-O

KM61K-S

## LIŠTA

obj. kód	typ	dĺžka	farba
40620001	KM62-S 1M	1 m	strieborná
40620002	KM62-S 2M	2 m	strieborná

## KRYT

obj. kód	typ	dĺžka	prevedenie
40131041	13-TK 1M	1 m	klik číry
40131042	13-TK 2M	2 m	klik číry
40131051	13-MK 1M	1 m	klik matný
40131052	13-MK 2M	2 m	klik matný
40131053	13-MK 20M	20 m	klik matný

## PRÍSLUŠENSTVO

obj. kód	typ	príslušenstvo
40612000	KM61K-S	koncovka strieborná
40612001	KM61K-S-O	koncovka s otvorom strieborná

## KM62

k obkladom  
a dlažbám



## ALU profily LED

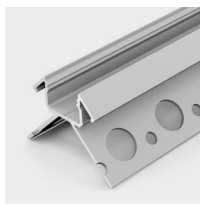

KM63-S

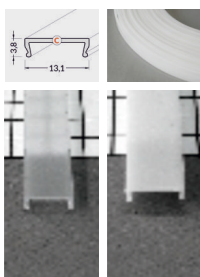

13-TK

13-MK



KM61K-S-O

KM61K-S

### KM63

k obkladom  
a dlažbám

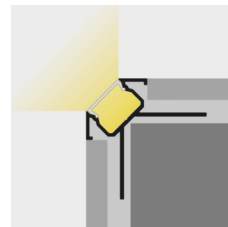
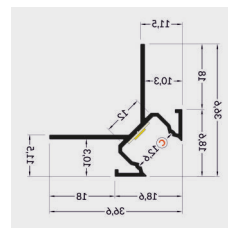

#### LIŠTA

obj. kód	typ	dĺžka	farba
40630001	KM63-S 1M	1 m	strieborná
40630002	KM63-S 2M	2 m	strieborná

#### KRYT

obj. kód	typ	dĺžka	prevedenie
40131041	13-TK 1M	1 m	klik číry
40131042	13-TK 2M	2 m	klik číry
40131051	13-MK 1M	1 m	klik matný
40131052	13-MK 2M	2 m	klik matný
40131053	13-MK 20M	20 m	klik matný

#### PRÍSLUŠENSTVO

obj. kód	typ	príslušenstvo
40612000	KM61K-S	koncovka strieborná
40612001	KM61K-S-O	koncovka s otvorom strieborná

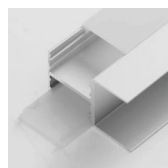
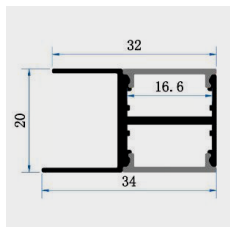

KM48-S

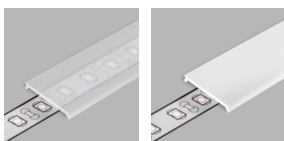

48-TK

48-MK



KM48K-S

KM48K-S-O

### KM48

policová

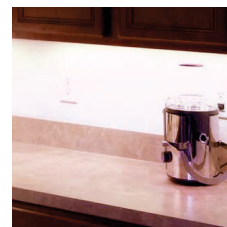
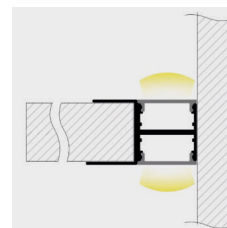

#### LIŠTA

obj. kód	typ	dĺžka	farba
40480001	KM34-S 1M	1 m	strieborná
40480002	KM34-S 2M	2 m	strieborná

#### KRYT

obj. kód	typ	dĺžka	prevedenie
40481041	34-TK 1M	1 m	klik číry
40481042	34-TK 2M	2 m	klik číry
40481051	34-MK 1M	1 m	klik matný
40481052	34-MK 2M	2 m	klik matný

#### PRÍSLUŠENSTVO

obj. kód	typ	príslušenstvo
40482000	KM34K-S	koncovka
40482001	KM34K-S-O	koncovka s otvorom

# ALU profily LED

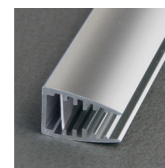
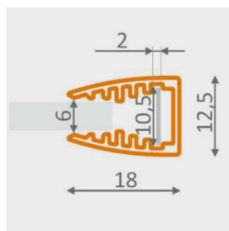

KM3-S

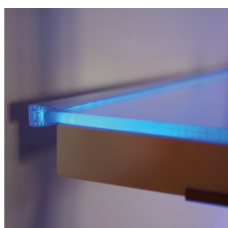

## LIŠTA

obj. kód	typ	dĺžka	farba
40030001	KM3-S 1M	1 m	strieborná
40030002	KM3-S 2M	2 m	strieborná

## PRÍSLUŠENSTVO

obj. kód	typ	príslušenstvo
40032000	KM3K	koncovka



KM3K

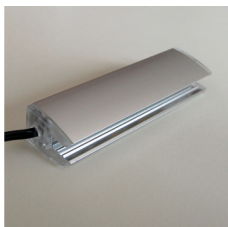

## KM3

na policu 6 mm

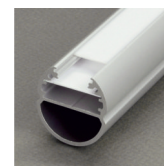
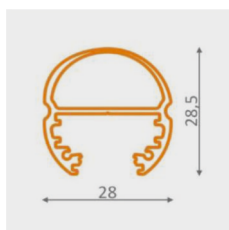

KM8-S

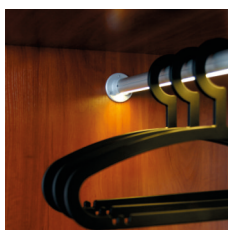

## LIŠTA

obj. kód	typ	dĺžka	farba
40080001	KM8-S 1M	1 m	strieborná
40080002	KM8-S 2M	2 m	strieborná

## KRYT

obj. kód	typ	dĺžka	prevedenie
40131011	13-T 1M	1 m	nasúvací číry
40131012	13-T 2M	2 m	nasúvací číry
40131021	13-S 1M	1 m	nasúvací mrazený
40131022	13-S 2M	2 m	nasúvací mrazený
40131031	13-M 1M	1 m	nasúvací matný
40131032	13-M 2M	2 m	nasúvací matný
40131041	13-TK 1M	1 m	klik číry
40131042	13-TK 2M	2 m	klik číry
40131051	13-MK 1M	1 m	klik matný
40131052	13-MK 2M	2 m	klik matný
40131053	13-MK 20M	20 m	klik matný

## PRÍSLUŠENSTVO

obj. kód	typ	príslušenstvo
40082000	KM8K	koncovka

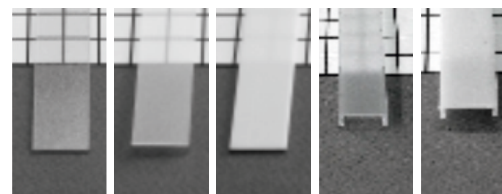

13-T 13-S 13-M 13-TK 13-MK

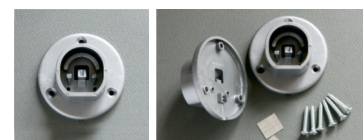

KM8K



## KM8

šatníkový profil



48-N IP20 RGB

## RGB 48-N IP20

led/m: 60  
lm/m: 420 lm  
Modul: 5 cm  
Rozmer: 8x2,5 mm

IP 20

12 V DC

3528 SMD

4,8 W/m

obj. kód	typ	W	farba svetla
50487201	48-N RGB IP20 1m	4,8	RGB
50487202	48-N RGB IP20 2m	9,6	RGB
50487203	48-N RGB IP20 3m	14,4	RGB
50487204	48-N RGB IP20 4m	19,2	RGB
50487205	48-N RGB IP20 5m	24,0	RGB

LED sada obsahuje LED pás, controller a zásuvkový napájací zdroj.

# LED sady



+



Možnosť výroby na mieru do 15 m

48-N IP20

obj. kód	typ	W	lm	farba svetla
50487231	48-N 3000K IP20 1m	4,8	420	teplá
50487241	48-N 4000K IP20 1m	4,8	420	neutrálna
50487261	48-N 6000K IP20 1m	4,8	420	studená
50487232	48-N 3000K IP20 2m	9,6	840	teplá
50487242	48-N 4000K IP20 2m	9,6	840	neutrálna
50487262	48-N 6000K IP20 2m	9,6	840	studená
50487233	48-N 3000K IP20 3m	14,4	1260	teplá
50487243	48-N 4000K IP20 3m	14,4	1260	neutrálna
50487263	48-N 6000K IP20 3m	14,4	1260	studená
50487234	48-N 3000K IP20 4m	19,2	1680	teplá
50487244	48-N 4000K IP20 4m	19,2	1680	neutrálna
50487264	48-N 6000K IP20 4m	19,2	1680	studená
50487235	48-N 3000K IP20 5m	24	2100	teplá
50487245	48-N 4000K IP20 5m	24	2100	neutrálna
50487265	48-N 6000K IP20 5m	24	2100	studená

## 48-N IP20

led/m: 60  
lm/m: 420 lm  
Modul: 5 cm  
Rozmer: 8x2,5 mm

IP 20

12 V DC

3528 SMD

4,8 W/m

LED sada obsahuje LED pás a zásuvkový napájací zdroj s vypínačom.



+



Možnosť výroby na mieru do 15 m

48-N IP65

obj. kód	typ	W	lm	farba svetla
50487631	48-N 3000K IP65 1m	4,8	420	teplá
50487641	48-N 4000K IP65 1m	4,8	420	neutrálna
50487661	48-N 6000K IP65 1m	4,8	420	studená
50487632	48-N 3000K IP65 2m	9,6	840	teplá
50487642	48-N 4000K IP65 2m	9,6	840	neutrálna
50487662	48-N 6000K IP65 2m	9,6	840	studená
50487633	48-N 3000K IP65 3m	14,4	1260	teplá
50487643	48-N 4000K IP65 3m	14,4	1260	neutrálna
50487663	48-N 6000K IP65 3m	14,4	1260	studená
50487634	48-N 3000K IP65 4m	19,2	1680	teplá
50487644	48-N 4000K IP65 4m	19,2	1680	neutrálna
50487664	48-N 6000K IP65 4m	19,2	1680	studená
50487635	48-N 3000K IP65 5m	24	2100	teplá
50487645	48-N 4000K IP65 5m	24	2100	neutrálna
50487665	48-N 6000K IP65 5m	24	2100	studená

## 48-N IP65

led/m: 60  
lm/m: 420 lm  
Modul: 5 cm  
Rozmer: 8x3 mm

IP 65

12 V DC

3528 SMD

4,8 W/m

LED sada obsahuje LED pás a zásuvkový napájací zdroj s vypínačom.



## LED sady



6-N IP20

Možnosť výroby na mieru do 15 m



### 6-N IP20

led/m: 30  
lm/m: 660 lm  
Modul: 10 cm  
Rozmer: 10x2,5 mm

IP 20

12 V DC

2835 SMD

6 W/m

obj. kód	typ	W	lm	farba svetla
50067231	6-N 3000K IP20 1m	6	660	teplá
50067241	6-N 4000K IP20 1m	6	660	neutrálna
50067261	6-N 6000K IP20 1m	6	660	studená
50067232	6-N 3000K IP20 2m	12	1320	teplá
50067242	6-N 4000K IP20 2m	12	1320	neutrálna
50067262	6-N 6000K IP20 2m	12	1320	studená
50067233	6-N 3000K IP20 3m	18	1980	teplá
50067243	6-N 4000K IP20 3m	18	1980	neutrálna
50067263	6-N 6000K IP20 3m	18	1980	studená
50067234	6-N 3000K IP20 4m	24	2640	teplá
50067244	6-N 4000K IP20 4m	24	2640	neutrálna
50067264	6-N 6000K IP20 4m	24	2640	studená

LED sada obsahuje LED pás a zásuvkový napájací zdroj s vypínačom.



6-N IP65

Možnosť výroby na mieru do 15 m



### 6-N IP65

led/m: 30  
lm/m: 660 lm  
Modul: 10 cm  
Rozmer: 10x3 mm

IP 65

12 V DC

2835 SMD

6 W/m

obj. kód	typ	W	lm	farba svetla
50067631	6-N 3000K IP65 1m	6	660	teplá
50067641	6-N 4000K IP65 1m	6	660	neutrálna
50067661	6-N 6000K IP65 1m	6	660	studená
50067632	6-N 3000K IP65 2m	12	1320	teplá
50067642	6-N 4000K IP65 2m	12	1320	neutrálna
50067662	6-N 6000K IP65 2m	12	1320	studená
50067633	6-N 3000K IP65 3m	18	1980	teplá
50067643	6-N 4000K IP65 3m	18	1980	neutrálna
50067663	6-N 6000K IP65 3m	18	1980	studená
50067634	6-N 3000K IP65 4m	24	2640	teplá
50067644	6-N 4000K IP65 4m	24	2640	neutrálna
50067664	6-N 6000K IP65 4m	24	2640	studená

LED sada obsahuje LED pás a zásuvkový napájací zdroj s vypínačom.

# LED sady



72-N IP20

**RGB**

**72-N IP20**

led/m: 30

lm/led: 20 lm

Modul: 10 cm

Rozmer: 10x2,5 mm

IP 20

12 V DC

5050SMD

7,2 W/m

obj. kód	typ	W	farba svetla
50727201	72-N RGB IP20 1m	7,2	RGB
50727202	72-N RGB IP20 2m	14,4	RGB
50727203	72-N RGB IP20 3m	21,6	RGB
50727204	72-N RGB IP20 4m	28,8	RGB
50727205	72-N RGB IP20 5m	36	RGB

LED sada obsahuje LED pás, controller a zásuvkový napájací zdroj.



72-N IP65

**RGB**

**72-N IP65**

led/m: 30

lm/led: 20 lm

Modul: 10 cm

Rozmer: 10x3 mm

IP 65

12 V DC

5050SMD

7,2 W/m

obj. kód	typ	W	farba svetla
50727601	72-N RGB IP65 1m	7,2	RGB
50727602	72-N RGB IP65 2m	14,4	RGB
50727603	72-N RGB IP65 3m	21,6	RGB
50727604	72-N RGB IP65 4m	28,8	RGB
50727605	72-N RGB IP65 5m	36	RGB

LED sada obsahuje LED pás, controller a zásuvkový napájací zdroj.



# LED sady

Možnosť výroby na mieru do 200 cm



KM34-S, strieborná

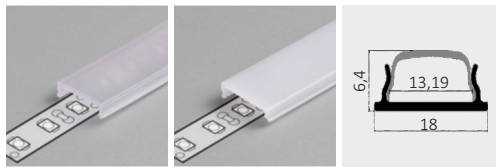

34-TK, klik číry

34-MK, klik matný

## LED sada

obj. kód	typ	kryt	W/m	lm/m
53403403	KM34-S-TK-48 3000K IP20	čírý klik	4,8	420
53403404	KM34-S-TK-48 4000K IP20	čírý klik	4,8	420
53403406	KM34-S-TK-48 6000K IP20	čírý klik	4,8	420
53404403	KM34-S-MK-48 3000K IP20	matný klik	4,8	420
53404404	KM34-S-MK-48 4000K IP20	matný klik	4,8	420
53404406	KM34-S-MK-48 6000K IP20	matný klik	4,8	420
53403603	KM34-S-TK-6 3000K IP20	čírý klik	6	660
53403604	KM34-S-TK-6 4000K IP20	čírý klik	6	660
53403606	KM34-S-TK-6 6000K IP20	čírý klik	6	660
53404603	KM34-S-MK-6 3000K IP20	matný klik	6	660
53404604	KM34-S-MK-6 4000K IP20	matný klik	6	660
53404606	KM34-S-MK-6 6000K IP20	matný klik	6	660

## LED sada

obj. kód	typ	kryt	W/m	lm/m
53403903	KM34-S-TK-96 3000K IP20	čírý klik	9,6	840
53403904	KM34-S-TK-96 4000K IP20	čírý klik	9,6	840
53403906	KM34-S-TK-96 6000K IP20	čírý klik	9,6	840
53404903	KM34-S-MK-96 3000K IP20	matný klik	9,6	840
53404904	KM34-S-MK-96 4000K IP20	matný klik	9,6	840
53404906	KM34-S-MK-96 6000K IP20	matný klik	9,6	840
53403103	KM34-S-TK-125 3000K IP20	čírý klik	12,5	1320
53403104	KM34-S-TK-125 4000K IP20	čírý klik	12,5	1320
53403106	KM34-S-TK-125 6000K IP20	čírý klik	12,5	1320
53404103	KM34-S-MK-125 3000K IP20	matný klik	12,5	1320
53404104	KM34-S-MK-125 4000K IP20	matný klik	12,5	1320
53404106	KM34-S-MK-125 6000K IP20	matný klik	12,5	1320

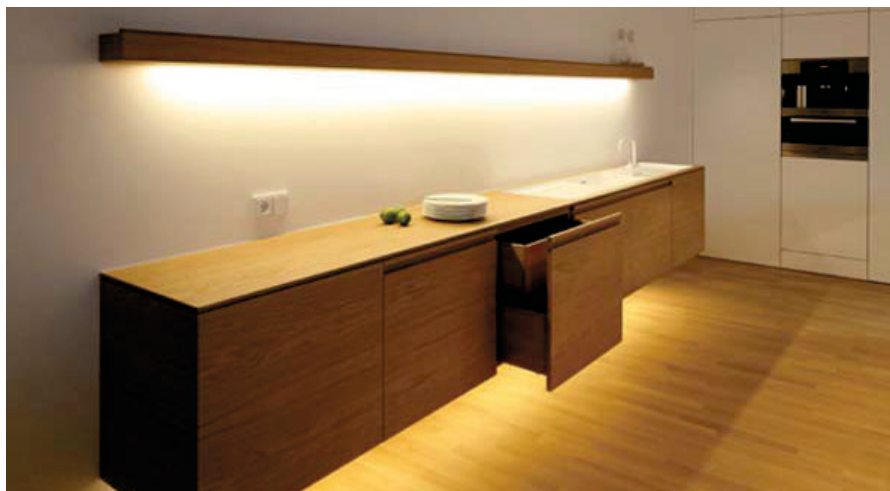

LED sada obsahuje lištu, kryt, koncovky, príchytky, LED pás a konektor 2.1,5.5 Y alebo kábel 2x0,35mm<sup>2</sup> v závislosti od použitého napájacieho zdroja.

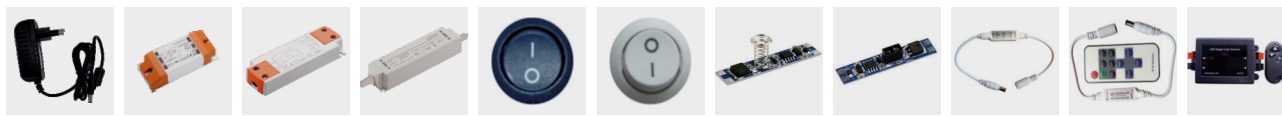

Najpoužívanejšie príslušenstvo

## KM34-S

materiál:  
hliník, plast  
LED pás

12 V

30000 h



Ra>90

### Napájací zdroj

obj. kód	typ	Vypínač	W	V
30310024	KMA-24-12	nie	24	12
30310036	KMA-36-12	nie	36	12
30310060	KMA-60-12	nie	60	12
30510012	KMM-12-12	-	12	12
30610020	KMC-20-15	-	20	12
30810024	KMV-24-12	-	24	12
30810040	KMV-40-12	-	40	12

### Vypínače

obj. kód	typ	W	V
20323061	Vypínač 250V, 6A, čierny	1500	250
20323060	Vypínač 250V, 6A, biely	1500	250
20312145	Vypínač dotykový KM-VD-02L	96/192	12/24
20312155	Vypínač bezdotykový KM-VB-02L	96/192	12/24

### Stmievacie

obj. kód	obj. kód	W	V
38443071	Stmievateľ manuál 72-144W	72-144	12-24
38443072	Stmievateľ 72-144W	72-144	12-24
38443096	Stmievateľ 96-192W	96-192	12-24

# LED sady



Možnosť výroby na mieru do 200 cm



KM36-S, strieborná

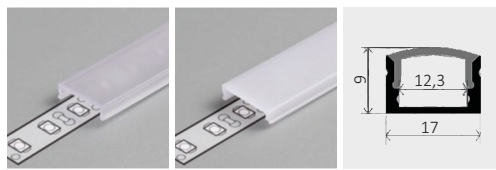

36-TK, klik číry

36-MK, klik matný

## LED sada

obj. kód	typ	kryt	W/m	lm/m
53603403	KM36-S-TK-48 3000K IP20	číry klik	4,8	420
53603404	KM36-S-TK-48 4000K IP20	číry klik	4,8	420
53603406	KM36-S-TK-48 6000K IP20	číry klik	4,8	420
53604403	KM36-S-MK-48 3000K IP20	matný klik	4,8	420
53604404	KM36-S-MK-48 4000K IP20	matný klik	4,8	420
53604406	KM36-S-MK-48 6000K IP20	matný klik	4,8	420
53603603	KM36-S-TK-6 3000K IP20	číry klik	6	660
53603604	KM36-S-TK-6 4000K IP20	číry klik	6	660
53603606	KM36-S-TK-6 6000K IP20	číry klik	6	660
53604603	KM36-S-MK-6 3000K IP20	matný klik	6	660
53604604	KM36-S-MK-6 4000K IP20	matný klik	6	660
53604606	KM36-S-MK-6 6000K IP20	matný klik	6	660

## LED sada

obj. kód	typ	kryt	W/m	lm/m
53603903	KM36-S-TK-96 3000K IP20	číry klik	9,6	840
53603904	KM36-S-TK-96 4000K IP20	číry klik	9,6	840
53603906	KM36-S-TK-96 6000K IP20	číry klik	9,6	840
53604903	KM36-S-MK-96 3000K IP20	matný klik	9,6	840
53604904	KM36-S-MK-96 4000K IP20	matný klik	9,6	840
53604906	KM36-S-MK-96 6000K IP20	matný klik	9,6	840
53603103	KM36-S-TK-125 3000K IP20	číry klik	12,5	1320
53603104	KM36-S-TK-125 4000K IP20	číry klik	12,5	1320
53603106	KM36-S-TK-125 6000K IP20	číry klik	12,5	1320
53604103	KM36-S-MK-125 3000K IP20	matný klik	12,5	1320
53604104	KM36-S-MK-125 4000K IP20	matný klik	12,5	1320
53604106	KM36-S-MK-125 6000K IP20	matný klik	12,5	1320



LED sada obsahuje lištu, kryt, koncovky, príchytky, LED pás a konektor 2.1,5,5 Y alebo kábel 2x0,35mm<sup>2</sup> v závislosti od použitého napájacieho zdroja.

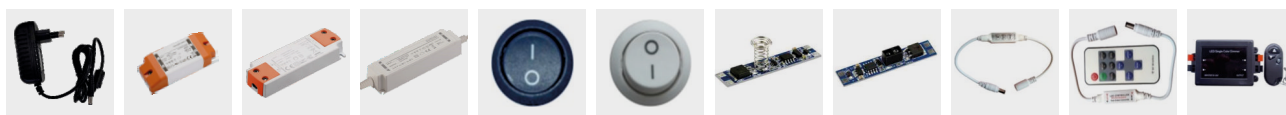

Najpoužívanejšie príslušenstvo

## Napájací zdroj

obj. kód	typ	Vypínač	W	V
30310024	KMA-24-12	nie	24	12
30310036	KMA-36-12	nie	36	12
30310060	KMA-60-12	nie	60	12
30510012	KMM-12-12	-	12	12
30610020	KMC-20-15	-	20	12
30810024	KMV-24-12	-	24	12
30810040	KMV-40-12	-	40	12

## Vypínače

obj. kód	typ	W	V
20323061	Vypínač 250V, 6A, čierny	1500	250
20323060	Vypínač 250V, 6A, biely	1500	250
20312145	Vypínač dotykový KM-VD-02L	96/192	12/24
20312155	Vypínač bezdotykový KM-VB-02L	96/192	12/24

## Stmievacie

obj. kód	obj. kód	W	V
38443071	Stmieváč manuál 72-144W	72-144	12-24
38443072	Stmieváč 72-144W	72-144	12-24
38443096	Stmieváč 96-192W	96-192	12-24

## KM36-S

materiál:  
hliník, plast  
LED pás

12 V

30000 h



Ra>90



# LED sady

Možnosť výroby na mieru do 200 cm

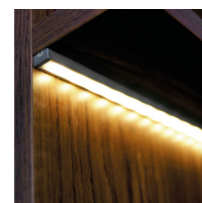

KM13-C, čierna

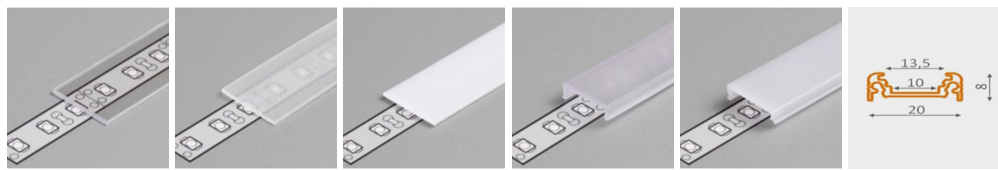

13-T, kryt číry

13-S, kryt mrazený

13-M, kryt matný

13-TK, klik číry

13-MK, klik matný

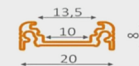

## LED sada

obj. kód	typ	kryt	W/m	lm/m
51320403	KM13-C-T-48 3000K IP20	číry	4,8	420
51320404	KM13-C-T-48 4000K IP20	číry	4,8	420
51320406	KM13-C-T-48 6000K IP20	číry	4,8	420
51321403	KM13-C-S-48 3000K IP20	mrazený	4,8	420
51321404	KM13-C-S-48 4000K IP20	mrazený	4,8	420
51321406	KM13-C-S-48 6000K IP20	mrazený	4,8	420
51322403	KM13-C-M-48 3000K IP20	matný	4,8	420
51322404	KM13-C-M-48 4000K IP20	matný	4,8	420
51322406	KM13-C-M-48 6000K IP20	matný	4,8	420
51323403	KM13-C-TK-48 3000K IP20	číry klik	4,8	420
51323404	KM13-C-TK-48 4000K IP20	číry klik	4,8	420
51323406	KM13-C-TK-48 6000K IP20	číry klik	4,8	420
51324403	KM13-C-MK-48 3000K IP20	matný klik	4,8	420
51324404	KM13-C-MK-48 4000K IP20	matný klik	4,8	420
51324406	KM13-C-MK-48 6000K IP20	matný klik	4,8	420
51320603	KM13-C-T-6 3000K IP20	číry	6	660
51320604	KM13-C-T-6 4000K IP20	číry	6	660
51320606	KM13-C-T-6 6000K IP20	číry	6	660
51321603	KM13-C-S-6 3000K IP20	mrazený	6	660
51321604	KM13-C-S-6 4000K IP20	mrazený	6	660
51321606	KM13-C-S-6 6000K IP20	mrazený	6	660
51322603	KM13-C-M-6 3000K IP20	matný	6	660
51322604	KM13-C-M-6 4000K IP20	matný	6	660
51322606	KM13-C-M-6 6000K IP20	matný	6	660
51323603	KM13-C-TK-6 3000K IP20	číry klik	6	660
51323604	KM13-C-TK-6 4000K IP20	číry klik	6	660
51323606	KM13-C-TK-6 6000K IP20	číry klik	6	660
51324603	KM13-C-MK-6 3000K IP20	matný klik	6	660
51324604	KM13-C-MK-6 4000K IP20	matný klik	6	660
51324606	KM13-C-MK-6 6000K IP20	matný klik	6	660

## LED sada

obj. kód	typ	kryt	W/m	lm/m
51320903	KM13-C-T-96 3000K IP20	číry	9,6	840
51320904	KM13-C-T-96 4000K IP20	číry	9,6	840
51320906	KM13-C-T-96 6000K IP20	číry	9,6	840
51321903	KM13-C-S-96 3000K IP20	mrazený	9,6	840
51321904	KM13-C-S-96 4000K IP20	mrazený	9,6	840
51321906	KM13-C-S-96 6000K IP20	mrazený	9,6	840
51322903	KM13-C-M-96 3000K IP20	matný	9,6	840
51322904	KM13-C-M-96 4000K IP20	matný	9,6	840
51322906	KM13-C-M-96 6000K IP20	matný	9,6	840
51323903	KM13-C-TK-96 3000K IP20	číry klik	9,6	840
51323904	KM13-C-TK-96 4000K IP20	číry klik	9,6	840
51323906	KM13-C-TK-96 6000K IP20	číry klik	9,6	840
51324903	KM13-C-MK-96 3000K IP20	matný klik	9,6	840
51324904	KM13-C-MK-96 4000K IP20	matný klik	9,6	840
51324906	KM13-C-MK-96 6000K IP20	matný klik	9,6	840
51320103	KM13-C-T-125 3000K IP20	číry	12,5	1320
51320104	KM13-C-T-125 4000K IP20	číry	12,5	1320
51320106	KM13-C-T-125 6000K IP20	číry	12,5	1320
51321103	KM13-C-S-125 3000K IP20	mrazený	12,5	1320
51321104	KM13-C-S-125 4000K IP20	mrazený	12,5	1320
51321106	KM13-C-S-125 6000K IP20	mrazený	12,5	1320
51322103	KM13-C-M-125 3000K IP20	matný	12,5	1320
51322104	KM13-C-M-125 4000K IP20	matný	12,5	1320
51322106	KM13-C-M-125 6000K IP20	matný	12,5	1320
51323103	KM13-C-TK-125 3000K IP20	číry klik	12,5	1320
51323104	KM13-C-TK-125 4000K IP20	číry klik	12,5	1320
51323106	KM13-C-TK-125 6000K IP20	číry klik	12,5	1320
51324103	KM13-C-MK-125 3000K IP20	matný klik	12,5	1320
51324104	KM13-C-MK-125 4000K IP20	matný klik	12,5	1320
51324106	KM13-C-MK-125 6000K IP20	matný klik	12,5	1320

LED sada obsahuje lištu, kryt, koncovky, príchytky, LED pás a konektor 2.1,5.5 Y alebo kábel 2x0,35mm<sup>2</sup> v závislosti od použitého napájacieho zdroja.



Najpoužívanejšie príslušenstvo

## KM13-C

materiál:  
hliník, plast  
LED pás

12 V

30000 h



Ra>90

### Napájací zdroj

obj. kód	typ	Vypínač	W	V
30310024	KMA-24-12	nie	24	12
30310036	KMA-36-12	nie	36	12
30310060	KMA-60-12	nie	60	12
30510012	KMM-12-12	-	12	12
30610020	KMC-20-15	-	20	12
30810024	KMV-24-12	-	24	12
30810040	KMV-40-12	-	40	12

### Vypínače

obj. kód	typ	W	V
20323061	Vypínač 250V, 6A, čierny	1500	250
20323060	Vypínač 250V, 6A, biely	1500	250
20312145	Vypínač dotykový KM-VD-02L	96/192	12/24
20312155	Vypínač bezdotykový KM-VB-02L	96/192	12/24

### Stmievače

obj. kód	obj. kód	W	V
38443071	Stmievač manuál 72-144W	72-144	12-24
38443072	Stmievač 72-144W	72-144	12-24
38443096	Stmievač 96-192W	96-192	12-24

# LED sady



KM13-B, biela

Možnosť výroby na mieru do 200 cm

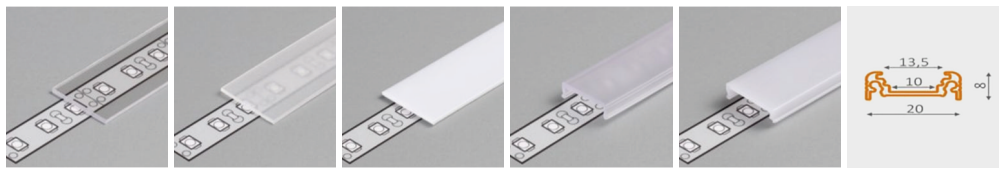

13-T, kryt číry

13-S, kryt mrazený

13-M, kryt matný

13-TK, klik číry

13-MK, klik matný

## LED sada

obj. kód	typ	kryt	W/m	lm/m
51310403	KM13-B-T-48 3000K IP20	číry	4,8	420
51310404	KM13-B-T-48 4000K IP20	číry	4,8	420
51310406	KM13-B-T-48 6000K IP20	číry	4,8	420
51311403	KM13-B-S-48 3000K IP20	mrazený	4,8	420
51311404	KM13-B-S-48 4000K IP20	mrazený	4,8	420
51311406	KM13-B-S-48 6000K IP20	mrazený	4,8	420
51312403	KM13-B-M-48 3000K IP20	matný	4,8	420
51312404	KM13-B-M-48 4000K IP20	matný	4,8	420
51312406	KM13-B-M-48 6000K IP20	matný	4,8	420
51313403	KM13-B-TK-48 3000K IP20	číry klik	4,8	420
51313404	KM13-B-TK-48 4000K IP20	číry klik	4,8	420
51313406	KM13-B-TK-48 6000K IP20	číry klik	4,8	420
51314403	KM13-B-MK-48 3000K IP20	matný klik	4,8	420
51314404	KM13-B-MK-48 4000K IP20	matný klik	4,8	420
51314406	KM13-B-MK-48 6000K IP20	matný klik	4,8	420
51310603	KM13-B-T-6 3000K IP20	číry	6	660
51310604	KM13-B-T-6 4000K IP20	číry	6	660
51310606	KM13-B-T-6 6000K IP20	číry	6	660
51311603	KM13-B-S-6 3000K IP20	mrazený	6	660
51311604	KM13-B-S-6 4000K IP20	mrazený	6	660
51311606	KM13-B-S-6 6000K IP20	mrazený	6	660
51312603	KM13-B-M-6 3000K IP20	matný	6	660
51312604	KM13-B-M-6 4000K IP20	matný	6	660
51312606	KM13-B-M-6 6000K IP20	matný	6	660
51313603	KM13-B-TK-6 3000K IP20	číry klik	6	660
51313604	KM13-B-TK-6 4000K IP20	číry klik	6	660
51313606	KM13-B-TK-6 6000K IP20	číry klik	6	660
51314603	KM13-B-MK-6 3000K IP20	matný klik	6	660
51314604	KM13-B-MK-6 4000K IP20	matný klik	6	660
51314606	KM13-B-MK-6 6000K IP20	matný klik	6	660

## LED sada

obj. kód	typ	kryt	W/m	lm/m
51310903	KM13-B-T-96 3000K IP20	číry	9,6	840
51310904	KM13-B-T-96 4000K IP20	číry	9,6	840
51310906	KM13-B-T-96 6000K IP20	číry	9,6	840
51311903	KM13-B-S-96 3000K IP20	mrazený	9,6	840
51311904	KM13-B-S-96 4000K IP20	mrazený	9,6	840
51311906	KM13-B-S-96 6000K IP20	mrazený	9,6	840
51312903	KM13-B-M-96 3000K IP20	matný	9,6	840
51312904	KM13-B-M-96 4000K IP20	matný	9,6	840
51312906	KM13-B-M-96 6000K IP20	matný	9,6	840
51313903	KM13-B-TK-96 3000K IP20	číry klik	9,6	840
51313904	KM13-B-TK-96 4000K IP20	číry klik	9,6	840
51313906	KM13-B-TK-96 6000K IP20	číry klik	9,6	840
51314903	KM13-B-MK-96 3000K IP20	matný klik	9,6	840
51314904	KM13-B-MK-96 4000K IP20	matný klik	9,6	840
51314906	KM13-B-MK-96 6000K IP20	matný klik	9,6	840
51310103	KM13-B-T-125 3000K IP20	číry	12,5	1320
51310104	KM13-B-T-125 4000K IP20	číry	12,5	1320
51310106	KM13-B-T-125 6000K IP20	číry	12,5	1320
51311103	KM13-B-S-125 3000K IP20	mrazený	12,5	1320
51311104	KM13-B-S-125 4000K IP20	mrazený	12,5	1320
51311106	KM13-B-S-125 6000K IP20	mrazený	12,5	1320
51312103	KM13-B-M-125 3000K IP20	matný	12,5	1320
51312104	KM13-B-M-125 4000K IP20	matný	12,5	1320
51312106	KM13-B-M-125 6000K IP20	matný	12,5	1320
51313103	KM13-B-TK-125 3000K IP20	číry klik	12,5	1320
51313104	KM13-B-TK-125 4000K IP20	číry klik	12,5	1320
51313106	KM13-B-TK-125 6000K IP20	číry klik	12,5	1320
51314103	KM13-B-MK-125 3000K IP20	matný klik	12,5	1320
51314104	KM13-B-MK-125 4000K IP20	matný klik	12,5	1320
51314106	KM13-B-MK-125 6000K IP20	matný klik	12,5	1320

LED sada obsahuje lištu, kryt, koncovky, príchytky, LED pás a konektor 2.1,5.5 Y alebo kábel 2x0,35mm<sup>2</sup> v závislosti od použitého napájacieho zdroja.



Najpoužívanejšie príslušenstvo

## Napájací zdroj

obj. kód	typ	Vypínač	W	V
30310024	KMA-24-12	nie	24	12
30310036	KMA-36-12	nie	36	12
30310060	KMA-60-12	nie	60	12
30510012	KMM-12-12	-	12	12
30610020	KMC-20-15	-	20	12
30810024	KMV-24-12	-	24	12
30810040	KMV-40-12	-	40	12

## Vypínače

obj. kód	typ	W	V
20323061	Vypínač 250V, 6A, čierny	1500	250
20323060	Vypínač 250V, 6A, biely	1500	250
20312145	Vypínač dotykový KM-VD-02L	96/192	12/24
20312155	Vypínač bezdotykový KM-VB-02L	96/192	12/24

## Stmievacie

obj. kód	obj. kód	W	V
38443071	Stmieváč manuál 72-144W	72-144	12-24
38443072	Stmieváč 72-144W	72-144	12-24
38443096	Stmieváč 96-192W	96-192	12-24

## KM13-B

materiál:  
hliník, plast  
LED pás

12 V

30000 h



Ra>90



# LED sady

Možnosť výroby na mieru do 200 cm



KM13-S, strieborná

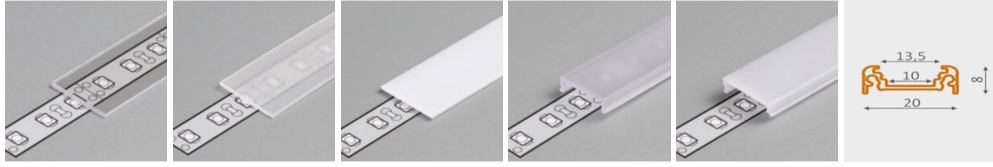

13-T, kryt číry

13-S, kryt mrazený

13-M, kryt matný

13-TK, klik číry

13-MK, klik matný

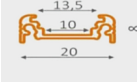

## LED sada

obj. kód	typ	kryt	W/m	lm/m
51300403	KM13-S-T-48 3000K IP20	číry	4,8	420
51300404	KM13-S-T-48 4000K IP20	číry	4,8	420
51300406	KM13-S-T-48 6000K IP20	číry	4,8	420
51301403	KM13-S-S-48 3000K IP20	mrazený	4,8	420
51301404	KM13-S-S-48 4000K IP20	mrazený	4,8	420
51301406	KM13-S-S-48 6000K IP20	mrazený	4,8	420
51302403	KM13-S-M-48 3000K IP20	matný	4,8	420
51302404	KM13-S-M-48 4000K IP20	matný	4,8	420
51302406	KM13-S-M-48 6000K IP20	matný	4,8	420
51303403	KM13-S-TK-48 3000K IP20	číry klik	4,8	420
51303404	KM13-S-TK-48 4000K IP20	číry klik	4,8	420
51303406	KM13-S-TK-48 6000K IP20	číry klik	4,8	420
51304403	KM13-S-MK-48 3000K IP20	matný klik	4,8	420
51304404	KM13-S-MK-48 4000K IP20	matný klik	4,8	420
51304406	KM13-S-MK-48 6000K IP20	matný klik	4,8	420
51300603	KM13-S-T-6 3000K IP20	číry	6	660
51300604	KM13-S-T-6 4000K IP20	číry	6	660
51300606	KM13-S-T-6 6000K IP20	číry	6	660
51301603	KM13-S-S-6 3000K IP20	mrazený	6	660
51301604	KM13-S-S-6 4000K IP20	mrazený	6	660
51301606	KM13-S-S-6 6000K IP20	mrazený	6	660
51302603	KM13-S-M-6 3000K IP20	matný	6	660
51302604	KM13-S-M-6 4000K IP20	matný	6	660
51302606	KM13-S-M-6 6000K IP20	matný	6	660
51303603	KM13-S-TK-6 3000K IP20	číry klik	6	660
51303604	KM13-S-TK-6 4000K IP20	číry klik	6	660
51303606	KM13-S-TK-6 6000K IP20	číry klik	6	660
51304603	KM13-S-MK-6 3000K IP20	matný klik	6	660
51304604	KM13-S-MK-6 4000K IP20	matný klik	6	660
51304606	KM13-S-MK-6 6000K IP20	matný klik	6	660

## LED sada

obj. kód	typ	kryt	W/m	lm/m
51300903	KM13-S-T-96 3000K IP20	číry	9,6	840
51300904	KM13-S-T-96 4000K IP20	číry	9,6	840
51300906	KM13-S-T-96 6000K IP20	číry	9,6	840
51301903	KM13-S-S-96 3000K IP20	mrazený	9,6	840
51301904	KM13-S-S-96 4000K IP20	mrazený	9,6	840
51301906	KM13-S-S-96 6000K IP20	mrazený	9,6	840
51302903	KM13-S-M-96 3000K IP20	matný	9,6	840
51302904	KM13-S-M-96 4000K IP20	matný	9,6	840
51302906	KM13-S-M-96 6000K IP20	matný	9,6	840
51303903	KM13-S-TK-96 3000K IP20	číry klik	9,6	840
51303904	KM13-S-TK-96 4000K IP20	číry klik	9,6	840
51303906	KM13-S-TK-96 6000K IP20	číry klik	9,6	840
51304903	KM13-S-MK-96 3000K IP20	matný klik	9,6	840
51304904	KM13-S-MK-96 4000K IP20	matný klik	9,6	840
51304906	KM13-S-MK-96 6000K IP20	matný klik	9,6	840
51300103	KM13-S-T-125 3000K IP20	číry	12,5	1320
51300104	KM13-S-T-125 4000K IP20	číry	12,5	1320
51300106	KM13-S-T-125 6000K IP20	číry	12,5	1320
51301103	KM13-S-S-125 3000K IP20	mrazený	12,5	1320
51301104	KM13-S-S-125 4000K IP20	mrazený	12,5	1320
51301106	KM13-S-S-125 6000K IP20	mrazený	12,5	1320
51302103	KM13-S-M-125 3000K IP20	matný	12,5	1320
51302104	KM13-S-M-125 4000K IP20	matný	12,5	1320
51302106	KM13-S-M-125 6000K IP20	matný	12,5	1320
51303103	KM13-S-TK-125 3000K IP20	číry klik	12,5	1320
51303104	KM13-S-TK-125 4000K IP20	číry klik	12,5	1320
51303106	KM13-S-TK-125 6000K IP20	číry klik	12,5	1320
51304103	KM13-S-MK-125 3000K IP20	matný klik	12,5	1320
51304104	KM13-S-MK-125 4000K IP20	matný klik	12,5	1320
51304106	KM13-S-MK-125 6000K IP20	matný klik	12,5	1320

LED sada obsahuje lištu, kryt, koncovky, príchytky, LED pás a konektor 2.1,5.5 Y alebo kábel 2x0,35mm<sup>2</sup> v závislosti od použitého napájacieho zdroja.



Najpoužívanejšie príslušenstvo

## KM13-S

materiál:  
hliník, plast  
LED pás

12 V

30000 h



Ra>90

### Napájací zdroj

obj. kód	typ	Vypínač	W	V
30310024	KMA-24-12	nie	24	12
30310036	KMA-36-12	nie	36	12
30310060	KMA-60-12	nie	60	12
30510012	KMM-12-12	-	12	12
30610020	KMC-20-15	-	20	12
30810024	KMV-24-12	-	24	12
30810040	KMV-40-12	-	40	12

### Vypínače

obj. kód	typ	W	V
20323061	Vypínač 250V, 6A, čierny	1500	250
20323060	Vypínač 250V, 6A, biely	1500	250
20312145	Vypínač dotykový KM-VD-02L	96/192	12/24
20312155	Vypínač bezdotykový KM-VB-02L	96/192	12/24

### Stmievacie

obj. kód	obj. kód	W	V
38443071	Stmievateľ manuál 72-144W	72-144	12-24
38443072	Stmievateľ 72-144W	72-144	12-24
38443096	Stmievateľ 96-192W	96-192	12-24

# LED sady



Možnosť výroby na mieru do 200 cm

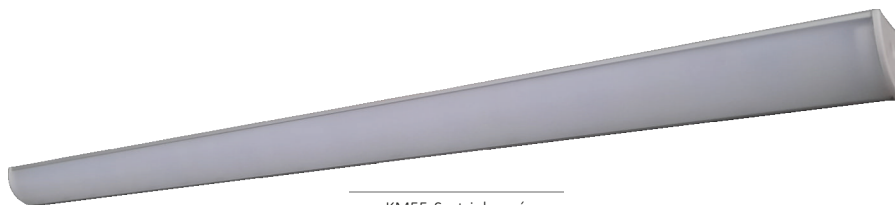

KM55-S, strieborná

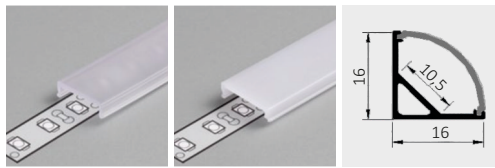

55-TK, klik číry

55-MK, klik matný

## LED sada

obj. kód	typ	kryt	W/m	lm/m
55503403	KM55-S-TK-48 3000K IP20	číry klik	4,8	420
55503404	KM55-S-TK-48 4000K IP20	číry klik	4,8	420
55503406	KM55-S-TK-48 6000K IP20	číry klik	4,8	420
55504403	KM55-S-MK-48 3000K IP20	matný klik	4,8	420
55504404	KM55-S-MK-48 4000K IP20	matný klik	4,8	420
55504406	KM55-S-MK-48 6000K IP20	matný klik	4,8	420
55503603	KM55-S-TK-6 3000K IP20	číry klik	6	660
55503604	KM55-S-TK-6 4000K IP20	číry klik	6	660
55503606	KM55-S-TK-6 6000K IP20	číry klik	6	660
55504603	KM55-S-MK-6 3000K IP20	matný klik	6	660
55504604	KM55-S-MK-6 4000K IP20	matný klik	6	660
55504606	KM55-S-MK-6 6000K IP20	matný klik	6	660

## LED sada

obj. kód	typ	kryt	W/m	lm/m
55503903	KM55-S-TK-96 3000K IP20	číry klik	9,6	840
55503904	KM55-S-TK-96 4000K IP20	číry klik	9,6	840
55503906	KM55-S-TK-96 6000K IP20	číry klik	9,6	840
55504903	KM55-S-MK-96 3000K IP20	matný klik	9,6	840
55504904	KM55-S-MK-96 4000K IP20	matný klik	9,6	840
55504906	KM55-S-MK-96 6000K IP20	matný klik	9,6	840
55503103	KM55-S-TK-125 3000K IP20	číry klik	12,5	1320
55503104	KM55-S-TK-125 4000K IP20	číry klik	12,5	1320
55503106	KM55-S-TK-125 6000K IP20	číry klik	12,5	1320
55504103	KM55-S-MK-125 3000K IP20	matný klik	12,5	1320
55504104	KM55-S-MK-125 4000K IP20	matný klik	12,5	1320
55504106	KM55-S-MK-125 6000K IP20	matný klik	12,5	1320



LED sada obsahuje lištu, kryt, koncovky, príchytky, LED pás a konektor 2.1,5,5 Y alebo kábel 2x0,35mm<sup>2</sup> v závislosti od použitého napájacieho zdroja.



Najpoužívanejšie príslušenstvo

## Napájací zdroj

obj. kód	typ	Vypínač	W	V
30310024	KMA-24-12	nie	24	12
30310036	KMA-36-12	nie	36	12
30310060	KMA-60-12	nie	60	12
30510012	KMM-12-12	-	12	12
30610020	KMC-20-15	-	20	12
30810024	KMV-24-12	-	24	12
30810040	KMV-40-12	-	40	12

## Vypínače

obj. kód	typ	W	V
20323061	Vypínač 250V, 6A, čierny	1500	250
20323060	Vypínač 250V, 6A, biely	1500	250
20312145	Vypínač dotykový KM-VD-02L	96/192	12/24
20312155	Vypínač bezdotykový KM-VB-02L	96/192	12/24

## Stmievacie

obj. kód	obj. kód	W	V
38443071	Stmieváč manuál 72-144W	72-144	12-24
38443072	Stmieváč 72-144W	72-144	12-24
38443096	Stmieváč 96-192W	96-192	12-24

## KM55-S

materiál:  
hliník, plast  
LED pás

12 V

30000 h



Ra>90



# LED sady

Možnosť výroby na mieru do 200 cm



KM18-C, čierny

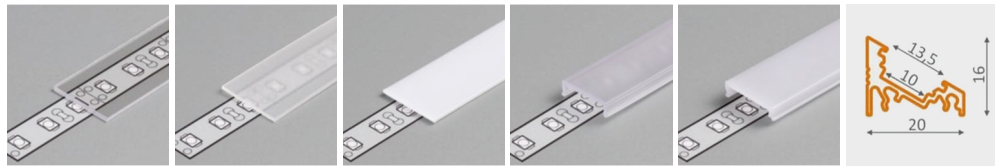
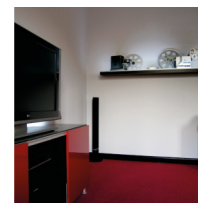

13-T, kryt číry

13-S, kryt mrazený

13-M, kryt matný

13-TK, klik číry

13-MK, klik matný

## LED sada

obj. kód	typ	kryt	W/m	lm/m
51820403	KM18-C-T-48 3000K IP20	číry	4,8	420
51820404	KM18-C-T-48 4000K IP20	číry	4,8	420
51820406	KM18-C-T-48 6000K IP20	číry	4,8	420
51821403	KM18-C-S-48 3000K IP20	mrazený	4,8	420
51821404	KM18-C-S-48 4000K IP20	mrazený	4,8	420
51821406	KM18-C-S-48 6000K IP20	mrazený	4,8	420
51822403	KM18-C-M-48 3000K IP20	matný	4,8	420
51822404	KM18-C-M-48 4000K IP20	matný	4,8	420
51822406	KM18-C-M-48 6000K IP20	matný	4,8	420
51823403	KM18-C-TK-48 3000K IP20	číry klik	4,8	420
51823404	KM18-C-TK-48 4000K IP20	číry klik	4,8	420
51823406	KM18-C-TK-48 6000K IP20	číry klik	4,8	420
51824403	KM18-C-MK-48 3000K IP20	matný klik	4,8	420
51824404	KM18-C-MK-48 4000K IP20	matný klik	4,8	420
51824406	KM18-C-MK-48 6000K IP20	matný klik	4,8	420
51820603	KM18-C-T-6 3000K IP20	číry	6	660
51820604	KM18-C-T-6 4000K IP20	číry	6	660
51820606	KM18-C-T-6 6000K IP20	číry	6	660
51821603	KM18-C-S-6 3000K IP20	mrazený	6	660
51821604	KM18-C-S-6 4000K IP20	mrazený	6	660
51821606	KM18-C-S-6 6000K IP20	mrazený	6	660
51822603	KM18-C-M-6 3000K IP20	matný	6	660
51822604	KM18-C-M-6 4000K IP20	matný	6	660
51822606	KM18-C-M-6 6000K IP20	matný	6	660
51823603	KM18-C-TK-6 3000K IP20	číry klik	6	660
51823604	KM18-C-TK-6 4000K IP20	číry klik	6	660
51823606	KM18-C-TK-6 6000K IP20	číry klik	6	660
51824603	KM18-C-MK-6 3000K IP20	matný klik	6	660
51824604	KM18-C-MK-6 4000K IP20	matný klik	6	660
51824606	KM18-C-MK-6 6000K IP20	matný klik	6	660

## LED sada

obj. kód	typ	kryt	W/m	lm/m
51820903	KM18-C-T-96 3000K IP20	číry	9,6	840
51820904	KM18-C-T-96 4000K IP20	číry	9,6	840
51820906	KM18-C-T-96 6000K IP20	číry	9,6	840
51821903	KM18-C-S-96 3000K IP20	mrazený	9,6	840
51821904	KM18-C-S-96 4000K IP20	mrazený	9,6	840
51821906	KM18-C-S-96 6000K IP20	mrazený	9,6	840
51822903	KM18-C-M-96 3000K IP20	matný	9,6	840
51822904	KM18-C-M-96 4000K IP20	matný	9,6	840
51822906	KM18-C-M-96 6000K IP20	matný	9,6	840
51823903	KM18-C-TK-96 3000K IP20	číry klik	9,6	840
51823904	KM18-C-TK-96 4000K IP20	číry klik	9,6	840
51823906	KM18-C-TK-96 6000K IP20	číry klik	9,6	840
51824903	KM18-C-MK-96 3000K IP20	matný klik	9,6	840
51824904	KM18-C-MK-96 4000K IP20	matný klik	9,6	840
51824906	KM18-C-MK-96 6000K IP20	matný klik	9,6	840
51820103	KM18-C-T-125 3000K IP20	číry	12,5	1320
51820104	KM18-C-T-125 4000K IP20	číry	12,5	1320
51820106	KM18-C-T-125 6000K IP20	číry	12,5	1320
51821103	KM18-C-S-125 3000K IP20	mrazený	12,5	1320
51821104	KM18-C-S-125 4000K IP20	mrazený	12,5	1320
51821106	KM18-C-S-125 6000K IP20	mrazený	12,5	1320
51822103	KM18-C-M-125 3000K IP20	matný	12,5	1320
51822104	KM18-C-M-125 4000K IP20	matný	12,5	1320
51822106	KM18-C-M-125 6000K IP20	matný	12,5	1320
51823103	KM18-C-TK-125 3000K IP20	číry klik	12,5	1320
51823104	KM18-C-TK-125 4000K IP20	číry klik	12,5	1320
51823106	KM18-C-TK-125 6000K IP20	číry klik	12,5	1320
51824103	KM18-C-MK-125 3000K IP20	matný klik	12,5	1320
51824104	KM18-C-MK-125 4000K IP20	matný klik	12,5	1320
51824106	KM18-C-MK-125 6000K IP20	matný klik	12,5	1320

LED sada obsahuje lištu, kryt, koncovky, príchytky, LED pás a konektor 2.1,5.5 Y alebo kábel 2x0,35mm<sup>2</sup> v závislosti od použitého napájacieho zdroja.



Najpoužívanejšie príslušenstvo

## KM18-C

materiál:  
hliník, plast  
LED pás

12 V

30000 h



Ra>90

### Napájací zdroj

obj. kód	typ	Vypínač	W	V
30310024	KMA-24-12	nie	24	12
30310036	KMA-36-12	nie	36	12
30310060	KMA-60-12	nie	60	12
30510012	KMM-12-12	-	12	12
30610020	KMC-20-15	-	20	12
30810024	KMV-24-12	-	24	12
30810040	KMV-40-12	-	40	12

### Vypínače

obj. kód	typ	W	V
20323061	Vypínač 250V, 6A, čierny	1500	250
20323060	Vypínač 250V, 6A, biely	1500	250
20312145	Vypínač dotykový KM-VD-02L	96/192	12/24
20312155	Vypínač bezdotykový KM-VB-02L	96/192	12/24

### Stmievacie

obj. kód	obj. kód	W	V
38443071	Stmievateľ manuál 72-144W	72-144	12-24
38443072	Stmievateľ 72-144W	72-144	12-24
38443096	Stmievateľ 96-192W	96-192	12-24

# LED sady

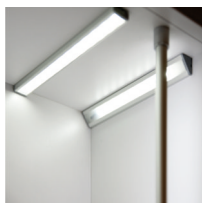

KM18-B, biely

Možnosť výroby na mieru do 200 cm

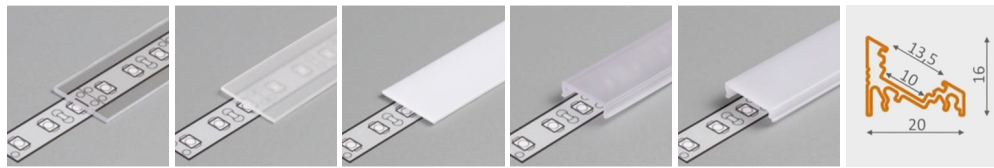

13-T, kryt číry

13-S, kryt mrazený

13-M, kryt matný

13-TK, klik číry

13-MK, klik matný

## LED sada

obj. kód	typ	kryt	W/m	lm/m
51810403	KM18-B-T-48 3000K IP20	číry	4,8	420
51810404	KM18-B-T-48 4000K IP20	číry	4,8	420
51810406	KM18-B-T-48 6000K IP20	číry	4,8	420
51811403	KM18-B-S-48 3000K IP20	mrazený	4,8	420
51811404	KM18-B-S-48 4000K IP20	mrazený	4,8	420
51811406	KM18-B-S-48 6000K IP20	mrazený	4,8	420
51812403	KM18-B-M-48 3000K IP20	matný	4,8	420
51812404	KM18-B-M-48 4000K IP20	matný	4,8	420
51812406	KM18-B-M-48 6000K IP20	matný	4,8	420
51813403	KM18-B-TK-48 3000K IP20	číry klik	4,8	420
51813404	KM18-B-TK-48 4000K IP20	číry klik	4,8	420
51813406	KM18-B-TK-48 6000K IP20	číry klik	4,8	420
51814403	KM18-B-MK-48 3000K IP20	matný klik	4,8	420
51814404	KM18-B-MK-48 4000K IP20	matný klik	4,8	420
51814406	KM18-B-MK-48 6000K IP20	matný klik	4,8	420
51810603	KM18-B-T-6 3000K IP20	číry	6	660
51810604	KM18-B-T-6 4000K IP20	číry	6	660
51810606	KM18-B-T-6 6000K IP20	číry	6	660
51811603	KM18-B-S-6 3000K IP20	mrazený	6	660
51811604	KM18-B-S-6 4000K IP20	mrazený	6	660
51811606	KM18-B-S-6 6000K IP20	mrazený	6	660
51812603	KM18-B-M-6 3000K IP20	matný	6	660
51812604	KM18-B-M-6 4000K IP20	matný	6	660
51812606	KM18-B-M-6 6000K IP20	matný	6	660
51813603	KM18-B-TK-6 3000K IP20	číry klik	6	660
51813604	KM18-B-TK-6 4000K IP20	číry klik	6	660
51813606	KM18-B-TK-6 6000K IP20	číry klik	6	660
51814603	KM18-B-MK-6 3000K IP20	matný klik	6	660
51814604	KM18-B-MK-6 4000K IP20	matný klik	6	660
51814606	KM18-B-MK-6 6000K IP20	matný klik	6	660

## LED sada

obj. kód	typ	kryt	W/m	lm/m
51810903	KM18-B-T-96 3000K IP20	číry	9,6	840
51810904	KM18-B-T-96 4000K IP20	číry	9,6	840
51810906	KM18-B-T-96 6000K IP20	číry	9,6	840
51811903	KM18-B-S-96 3000K IP20	mrazený	9,6	840
51811904	KM18-B-S-96 4000K IP20	mrazený	9,6	840
51811906	KM18-B-S-96 6000K IP20	mrazený	9,6	840
51812903	KM18-B-M-96 3000K IP20	matný	9,6	840
51812904	KM18-B-M-96 4000K IP20	matný	9,6	840
51812906	KM18-B-M-96 6000K IP20	matný	9,6	840
51813903	KM18-B-TK-96 3000K IP20	číry klik	9,6	840
51813904	KM18-B-TK-96 4000K IP20	číry klik	9,6	840
51813906	KM18-B-TK-96 6000K IP20	číry klik	9,6	840
51814903	KM18-B-MK-96 3000K IP20	matný klik	9,6	840
51814904	KM18-B-MK-96 4000K IP20	matný klik	9,6	840
51814906	KM18-B-MK-96 6000K IP20	matný klik	9,6	840
51810103	KM18-B-T-125 3000K IP20	číry	12,5	1320
51810104	KM18-B-T-125 4000K IP20	číry	12,5	1320
51810106	KM18-B-T-125 6000K IP20	číry	12,5	1320
51811103	KM18-B-S-125 3000K IP20	mrazený	12,5	1320
51811104	KM18-B-S-125 4000K IP20	mrazený	12,5	1320
51811106	KM18-B-S-125 6000K IP20	mrazený	12,5	1320
51812103	KM18-B-M-125 3000K IP20	matný	12,5	1320
51812104	KM18-B-M-125 4000K IP20	matný	12,5	1320
51812106	KM18-B-M-125 6000K IP20	matný	12,5	1320
51813103	KM18-B-TK-125 3000K IP20	číry klik	12,5	1320
51813104	KM18-B-TK-125 4000K IP20	číry klik	12,5	1320
51813106	KM18-B-TK-125 6000K IP20	číry klik	12,5	1320
51814103	KM18-B-MK-125 3000K IP20	matný klik	12,5	1320
51814104	KM18-B-MK-125 4000K IP20	matný klik	12,5	1320
51814106	KM18-B-MK-125 6000K IP20	matný klik	12,5	1320

LED sada obsahuje lištu, kryt, koncovky, príchytky, LED pás a konektor 2.1,5.5 Y alebo kábel 2x0,35mm<sup>2</sup> v závislosti od použitého napájacieho zdroja.



Najpoužívanejšie príslušenstvo

## Napájací zdroj

obj. kód	typ	Vypínač	W	V
30310024	KMA-24-12	nie	24	12
30310036	KMA-36-12	nie	36	12
30310060	KMA-60-12	nie	60	12
30510012	KMM-12-12	-	12	12
30610020	KMC-20-15	-	20	12
30810024	KMV-24-12	-	24	12
30810040	KMV-40-12	-	40	12

## Vypínače

obj. kód	typ	W	V
20323061	Vypínač 250V, 6A, čierny	1500	250
20323060	Vypínač 250V, 6A, biely	1500	250
20312145	Vypínač dotykový KM-VD-02L	96/192	12/24
20312155	Vypínač bezdotykový KM-VB-02L	96/192	12/24

## Stmievacie

obj. kód	obj. kód	W	V
38443071	Stmieváč manuál 72-144W	72-144	12-24
38443072	Stmieváč 72-144W	72-144	12-24
38443096	Stmieváč 96-192W	96-192	12-24

## KM18-B

materiál:  
hliník, plast  
LED pás

12 V

30000 h



Ra>90



# LED sady

Možnosť výroby na mieru do 200 cm



KM18-S, strieborný

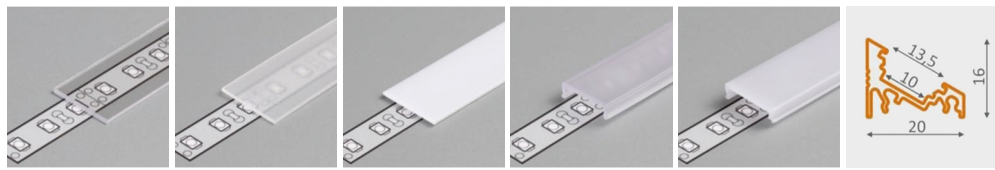

13-T, kryt číry

13-S, kryt mrazený

13-M, kryt matný

13-TK, klik číry

13-MK, klik matný

## LED sada

obj. kód	typ	kryt	W/m	lm/m
51800403	KM18-S-T-48 3000K IP20	číry	4,8	420
51800404	KM18-S-T-48 4000K IP20	číry	4,8	420
51800406	KM18-S-T-48 6000K IP20	číry	4,8	420
51801403	KM18-S-S-48 3000K IP20	mrazený	4,8	420
51801404	KM18-S-S-48 4000K IP20	mrazený	4,8	420
51801406	KM18-S-S-48 6000K IP20	mrazený	4,8	420
51802403	KM18-S-M-48 3000K IP20	matný	4,8	420
51802404	KM18-S-M-48 4000K IP20	matný	4,8	420
51802406	KM18-S-M-48 6000K IP20	matný	4,8	420
51803403	KM18-S-TK-48 3000K IP20	číry klik	4,8	420
51803404	KM18-S-TK-48 4000K IP20	číry klik	4,8	420
51803406	KM18-S-TK-48 6000K IP20	číry klik	4,8	420
51804403	KM18-S-MK-48 3000K IP20	matný klik	4,8	420
51804404	KM18-S-MK-48 4000K IP20	matný klik	4,8	420
51804406	KM18-S-MK-48 6000K IP20	matný klik	4,8	420
51800603	KM18-S-T-6 3000K IP20	číry	6	660
51800604	KM18-S-T-6 4000K IP20	číry	6	660
51800606	KM18-S-T-6 6000K IP20	číry	6	660
51801603	KM18-S-S-6 3000K IP20	mrazený	6	660
51801604	KM18-S-S-6 4000K IP20	mrazený	6	660
51801606	KM18-S-S-6 6000K IP20	mrazený	6	660
51802603	KM18-S-M-6 3000K IP20	matný	6	660
51802604	KM18-S-M-6 4000K IP20	matný	6	660
51802606	KM18-S-M-6 6000K IP20	matný	6	660
51803603	KM18-S-TK-6 3000K IP20	číry klik	6	660
51803604	KM18-S-TK-6 4000K IP20	číry klik	6	660
51803606	KM18-S-TK-6 6000K IP20	číry klik	6	660
51804603	KM18-S-MK-6 3000K IP20	matný klik	6	660
51804604	KM18-S-MK-6 4000K IP20	matný klik	6	660
51804606	KM18-S-MK-6 6000K IP20	matný klik	6	660

## LED sada

obj. kód	typ	kryt	W/m	lm/m
51800903	KM18-S-T-96 3000K IP20	číry	9,6	840
51800904	KM18-S-T-96 4000K IP20	číry	9,6	840
51800906	KM18-S-T-96 6000K IP20	číry	9,6	840
51801903	KM18-S-S-96 3000K IP20	mrazený	9,6	840
51801904	KM18-S-S-96 4000K IP20	mrazený	9,6	840
51801906	KM18-S-S-96 6000K IP20	mrazený	9,6	840
51802903	KM18-S-M-96 3000K IP20	matný	9,6	840
51802904	KM18-S-M-96 4000K IP20	matný	9,6	840
51802906	KM18-S-M-96 6000K IP20	matný	9,6	840
51803903	KM18-S-TK-96 3000K IP20	číry klik	9,6	840
51803904	KM18-S-TK-96 4000K IP20	číry klik	9,6	840
51803906	KM18-S-TK-96 6000K IP20	číry klik	9,6	840
51804903	KM18-S-MK-96 3000K IP20	matný klik	9,6	840
51804904	KM18-S-MK-96 4000K IP20	matný klik	9,6	840
51804906	KM18-S-MK-96 6000K IP20	matný klik	9,6	840
51800103	KM18-S-T-125 3000K IP20	číry	12,5	1320
51800104	KM18-S-T-125 4000K IP20	číry	12,5	1320
51800106	KM18-S-T-125 6000K IP20	číry	12,5	1320
51801103	KM18-S-S-125 3000K IP20	mrazený	12,5	1320
51801104	KM18-S-S-125 4000K IP20	mrazený	12,5	1320
51801106	KM18-S-S-125 6000K IP20	mrazený	12,5	1320
51802103	KM18-S-M-125 3000K IP20	matný	12,5	1320
51802104	KM18-S-M-125 4000K IP20	matný	12,5	1320
51802106	KM18-S-M-125 6000K IP20	matný	12,5	1320
51803103	KM18-S-TK-125 3000K IP20	číry klik	12,5	1320
51803104	KM18-S-TK-125 4000K IP20	číry klik	12,5	1320
51803106	KM18-S-TK-125 6000K IP20	číry klik	12,5	1320
51804103	KM18-S-MK-125 3000K IP20	matný klik	12,5	1320
51804104	KM18-S-MK-125 4000K IP20	matný klik	12,5	1320
51804106	KM18-S-MK-125 6000K IP20	matný klik	12,5	1320

LED sada obsahuje lištu, kryt, koncovky, príchytky, LED pás a konektor 2.1,5.5 Y alebo kábel 2x0,35mm<sup>2</sup> v závislosti od použitého napájacieho zdroja.



Najpoužívanejšie príslušenstvo

## KM18-S

materiál:  
hliník, plast  
LED pás

12 V

30000 h



Ra>90

### Napájací zdroj

obj. kód	typ	Vypínač	W	V
30310024	KMA-24-12	nie	24	12
30310036	KMA-36-12	nie	36	12
30310060	KMA-60-12	nie	60	12
30510012	KMM-12-12	-	12	12
30610020	KMC-20-15	-	20	12
30810024	KMV-24-12	-	24	12
30810040	KMV-40-12	-	40	12

### Vypínače

obj. kód	typ	W	V
20323061	Vypínač 250V, 6A, čierny	1500	250
20323060	Vypínač 250V, 6A, biely	1500	250
20312145	Vypínač dotykový KM-VD-02L	96/192	12/24
20312155	Vypínač bezdotykový KM-VB-02L	96/192	12/24

### Stmievače

obj. kód	obj. kód	W	V
38443071	Stmievač manuál 72-144W	72-144	12-24
38443072	Stmievač 72-144W	72-144	12-24
38443096	Stmievač 96-192W	96-192	12-24

# LED sady



KM39-S, strieborná

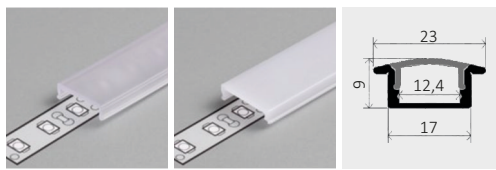

36-TK, klik číry

36-MK, klik matný

Možnosť výroby na mieru do 200 cm

## LED sada

obj. kód	typ	kryt	W/m	lm/m
53903403	KM39-S-TK-48 3000K IP20	číry klik	4,8	420
53903404	KM39-S-TK-48 4000K IP20	číry klik	4,8	420
53903406	KM39-S-TK-48 6000K IP20	číry klik	4,8	420
53904403	KM39-S-MK-48 3000K IP20	matný klik	4,8	420
53904404	KM39-S-MK-48 4000K IP20	matný klik	4,8	420
53904406	KM39-S-MK-48 6000K IP20	matný klik	4,8	420
53903603	KM39-S-TK-6 3000K IP20	číry klik	6	660
53903604	KM39-S-TK-6 4000K IP20	číry klik	6	660
53903606	KM39-S-TK-6 6000K IP20	číry klik	6	660
53904603	KM39-S-MK-6 3000K IP20	matný klik	6	660
53904604	KM39-S-MK-6 4000K IP20	matný klik	6	660
53904606	KM39-S-MK-6 6000K IP20	matný klik	6	660

## LED sada

obj. kód	typ	kryt	W/m	lm/m
53903903	KM39-S-TK-96 3000K IP20	číry klik	9,6	840
53903904	KM39-S-TK-96 4000K IP20	číry klik	9,6	840
53903906	KM39-S-TK-96 6000K IP20	číry klik	9,6	840
53904903	KM39-S-MK-96 3000K IP20	matný klik	9,6	840
53904904	KM39-S-MK-96 4000K IP20	matný klik	9,6	840
53904906	KM39-S-MK-96 6000K IP20	matný klik	9,6	840
53903103	KM39-S-TK-125 3000K IP20	číry klik	12,5	1320
53903104	KM39-S-TK-125 4000K IP20	číry klik	12,5	1320
53903106	KM39-S-TK-125 6000K IP20	číry klik	12,5	1320
53904103	KM39-S-MK-125 3000K IP20	matný klik	12,5	1320
53904104	KM39-S-MK-125 4000K IP20	matný klik	12,5	1320
53904106	KM39-S-MK-125 6000K IP20	matný klik	12,5	1320

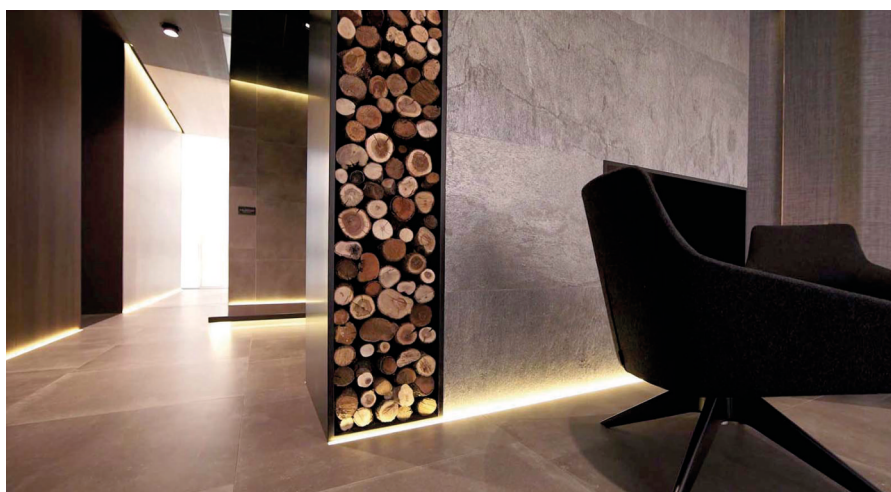

LED sada obsahuje lištu, kryt, koncovky, príchytky, LED pás a konektor 2.1,5,5 Y alebo kábel 2x0,35mm<sup>2</sup> v závislosti od použitého napájacieho zdroja.



Najpoužívanejšie príslušenstvo

## Napájací zdroj

obj. kód	typ	Vypínač	W	V
30310024	KMA-24-12	nie	24	12
30310036	KMA-36-12	nie	36	12
30310060	KMA-60-12	nie	60	12
30510012	KMM-12-12	-	12	12
30610020	KMC-20-15	-	20	12
30810024	KMV-24-12	-	24	12
30810040	KMV-40-12	-	40	12

## Vypínače

obj. kód	typ	W	V
20323061	Vypínač 250V, 6A, čierny	1500	250
20323060	Vypínač 250V, 6A, biely	1500	250
20312145	Vypínač dotykový KM-VD-02L	96/192	12/24
20312155	Vypínač bezdotykový KM-VB-02L	96/192	12/24

## Stmievacie

obj. kód	obj. kód	W	V
38443071	Stmieváč manuál 72-144W	72-144	12-24
38443072	Stmieváč 72-144W	72-144	12-24
38443096	Stmieváč 96-192W	96-192	12-24

## KM39-S

materiál:  
hliník, plast  
LED pás

12 V

30000 h



Ra>90



# LED sady

Možnosť výroby na mieru do 200 cm



KM15-C, čierna

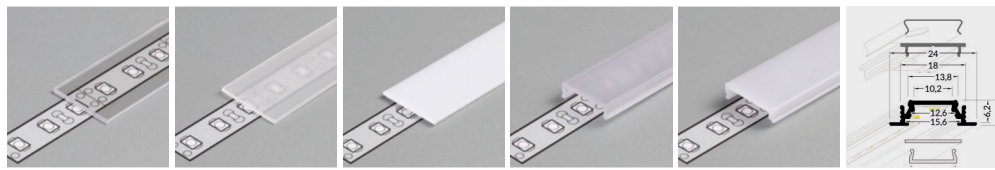

13-T, kryt číry

13-S, kryt mrazený

13-M, kryt matný

13-TK, klik číry

13-MK, klik matný

## LED sada

obj. kód	typ	kryt	W/m	lm/m
51520403	KM15-C-T-48 3000K IP20	číry	4,8	420
51520404	KM15-C-T-48 4000K IP20	číry	4,8	420
51520406	KM15-C-T-48 6000K IP20	číry	4,8	420
51521403	KM15-C-S-48 3000K IP20	mrazený	4,8	420
51521404	KM15-C-S-48 4000K IP20	mrazený	4,8	420
51521406	KM15-C-S-48 6000K IP20	mrazený	4,8	420
51522403	KM15-C-M-48 3000K IP20	matný	4,8	420
51522404	KM15-C-M-48 4000K IP20	matný	4,8	420
51522406	KM15-C-M-48 6000K IP20	matný	4,8	420
51523403	KM15-C-TK-48 3000K IP20	číry klik	4,8	420
51523404	KM15-C-TK-48 4000K IP20	číry klik	4,8	420
51523406	KM15-C-TK-48 6000K IP20	číry klik	4,8	420
51524403	KM15-C-MK-48 3000K IP20	matný klik	4,8	420
51524404	KM15-C-MK-48 4000K IP20	matný klik	4,8	420
51524406	KM15-C-MK-48 6000K IP20	matný klik	4,8	420
51520603	KM15-C-T-6 3000K IP20	číry	6	660
51520604	KM15-C-T-6 4000K IP20	číry	6	660
51520606	KM15-C-T-6 6000K IP20	číry	6	660
51521603	KM15-C-S-6 3000K IP20	mrazený	6	660
51521604	KM15-C-S-6 4000K IP20	mrazený	6	660
51521606	KM15-C-S-6 6000K IP20	mrazený	6	660
51522603	KM15-C-M-6 3000K IP20	matný	6	660
51522604	KM15-C-M-6 4000K IP20	matný	6	660
51522606	KM15-C-M-6 6000K IP20	matný	6	660
51523603	KM15-C-TK-6 3000K IP20	číry klik	6	660
51523604	KM15-C-TK-6 4000K IP20	číry klik	6	660
51523606	KM15-C-TK-6 6000K IP20	číry klik	6	660
51524603	KM15-C-MK-6 3000K IP20	matný klik	6	660
51524604	KM15-C-MK-6 4000K IP20	matný klik	6	660
51524606	KM15-C-MK-6 6000K IP20	matný klik	6	660

## LED sada

obj. kód	typ	kryt	W/m	lm/m
51520903	KM15-C-T-96 3000K IP20	číry	9,6	840
51520904	KM15-C-T-96 4000K IP20	číry	9,6	840
51520906	KM15-C-T-96 6000K IP20	číry	9,6	840
51521903	KM15-C-S-96 3000K IP20	mrazený	9,6	840
51521904	KM15-C-S-96 4000K IP20	mrazený	9,6	840
51521906	KM15-C-S-96 6000K IP20	mrazený	9,6	840
51522903	KM15-C-M-96 3000K IP20	matný	9,6	840
51522904	KM15-C-M-96 4000K IP20	matný	9,6	840
51522906	KM15-C-M-96 6000K IP20	matný	9,6	840
51523903	KM15-C-TK-96 3000K IP20	číry klik	9,6	840
51523904	KM15-C-TK-96 4000K IP20	číry klik	9,6	840
51523906	KM15-C-TK-96 6000K IP20	číry klik	9,6	840
51524903	KM15-C-MK-96 3000K IP20	matný klik	9,6	840
51524904	KM15-C-MK-96 4000K IP20	matný klik	9,6	840
51524906	KM15-C-MK-96 6000K IP20	matný klik	9,6	840
51520103	KM15-C-T-125 3000K IP20	číry	12,5	1320
51520104	KM15-C-T-125 4000K IP20	číry	12,5	1320
51520106	KM15-C-T-125 6000K IP20	číry	12,5	1320
51521103	KM15-C-S-125 3000K IP20	mrazený	12,5	1320
51521104	KM15-C-S-125 4000K IP20	mrazený	12,5	1320
51521106	KM15-C-S-125 6000K IP20	mrazený	12,5	1320
51522103	KM15-C-M-125 3000K IP20	matný	12,5	1320
51522104	KM15-C-M-125 4000K IP20	matný	12,5	1320
51522106	KM15-C-M-125 6000K IP20	matný	12,5	1320
51523103	KM15-C-TK-125 3000K IP20	číry klik	12,5	1320
51523104	KM15-C-TK-125 4000K IP20	číry klik	12,5	1320
51523106	KM15-C-TK-125 6000K IP20	číry klik	12,5	1320
51524103	KM15-C-MK-125 3000K IP20	matný klik	12,5	1320
51524104	KM15-C-MK-125 4000K IP20	matný klik	12,5	1320
51524106	KM15-C-MK-125 6000K IP20	matný klik	12,5	1320

LED sada obsahuje lištu, kryt, koncovky, príchytky, LED pás a konektor 2.1,5.5 Y alebo kábel 2x0,35mm<sup>2</sup> v závislosti od použitého napájacieho zdroja.

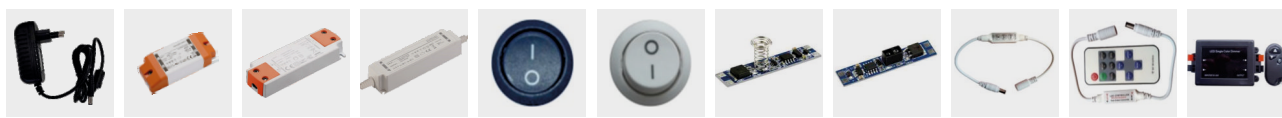

Najpoužívanejšie príslušenstvo

## KM15-C

materiál:  
hliník, plast  
LED pás

12 V

30000 h



Ra>90

### Napájací zdroj

obj. kód	typ	Vypínač	W	V
30310024	KMA-24-12	nie	24	12
30310036	KMA-36-12	nie	36	12
30310060	KMA-60-12	nie	60	12
30510012	KMM-12-12	-	12	12
30610020	KMC-20-15	-	20	12
30810024	KMV-24-12	-	24	12
30810040	KMV-40-12	-	40	12

### Vypínače

obj. kód	typ	W	V
20323061	Vypínač 250V, 6A, čierny	1500	250
20323060	Vypínač 250V, 6A, biely	1500	250
20312145	Vypínač dotykový KM-VD-02L	96/192	12/24
20312155	Vypínač bezdotykový KM-VB-02L	96/192	12/24

### Stmievače

obj. kód	obj. kód	W	V
38443071	Stmievač manuál 72-144W	72-144	12-24
38443072	Stmievač 72-144W	72-144	12-24
38443096	Stmievač 96-192W	96-192	12-24

# LED sady

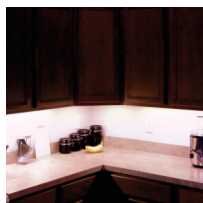

KM15-B, biela

Možnosť výroby na mieru do 200 cm

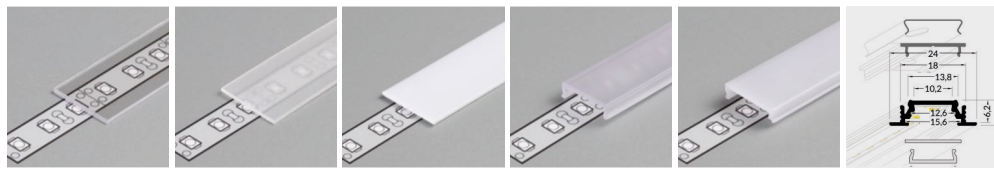

13-T, kryt číry    13-S, kryt mrazený    13-M, kryt matný    13-TK, klik číry    13-MK, klik matný

## LED sada

obj. kód	typ	kryt	W/m	lm/m
51510403	KM15-B-T-48 3000K IP20	číry	4,8	420
51510404	KM15-B-T-48 4000K IP20	číry	4,8	420
55310406	KM15-B-T-48 6000K IP20	číry	4,8	420
51511403	KM15-B-S-48 3000K IP20	mrazený	4,8	420
51511404	KM15-B-S-48 4000K IP20	mrazený	4,8	420
51511406	KM15-B-S-48 6000K IP20	mrazený	4,8	420
51512403	KM15-B-M-48 3000K IP20	matný	4,8	420
51512404	KM15-B-M-48 4000K IP20	matný	4,8	420
51512406	KM15-B-M-48 6000K IP20	matný	4,8	420
51513403	KM15-B-TK-48 3000K IP20	číry klik	4,8	420
51513404	KM15-B-TK-48 4000K IP20	číry klik	4,8	420
51513406	KM15-B-TK-48 6000K IP20	číry klik	4,8	420
51514403	KM15-B-MK-48 3000K IP20	matný klik	4,8	420
51514404	KM15-B-MK-48 4000K IP20	matný klik	4,8	420
51514406	KM15-B-MK-48 6000K IP20	matný klik	4,8	420
51510603	KM15-B-T-6 3000K IP20	číry	6	660
51510604	KM15-B-T-6 4000K IP20	číry	6	660
51510606	KM15-B-T-6 6000K IP20	číry	6	660
51511603	KM15-B-S-6 3000K IP20	mrazený	6	660
51511604	KM15-B-S-6 4000K IP20	mrazený	6	660
51511606	KM15-B-S-6 6000K IP20	mrazený	6	660
51512603	KM15-B-M-6 3000K IP20	matný	6	660
51512604	KM15-B-M-6 4000K IP20	matný	6	660
51512606	KM15-B-M-6 6000K IP20	matný	6	660
51513603	KM15-B-TK-6 3000K IP20	číry klik	6	660
51513604	KM15-B-TK-6 4000K IP20	číry klik	6	660
51513606	KM15-B-TK-6 6000K IP20	číry klik	6	660
51514603	KM15-B-MK-6 3000K IP20	matný klik	6	660
51514604	KM15-B-MK-6 4000K IP20	matný klik	6	660
51514606	KM15-B-MK-6 6000K IP20	matný klik	6	660

## LED sada

obj. kód	typ	kryt	W/m	lm/m
51510903	KM15-B-T-96 3000K IP20	číry	9,6	840
51510904	KM15-B-T-96 4000K IP20	číry	9,6	840
51510906	KM15-B-T-96 6000K IP20	číry	9,6	840
51511903	KM15-B-S-96 3000K IP20	mrazený	9,6	840
51511904	KM15-B-S-96 4000K IP20	mrazený	9,6	840
51511906	KM15-B-S-96 6000K IP20	mrazený	9,6	840
51512903	KM15-B-M-96 3000K IP20	matný	9,6	840
51512904	KM15-B-M-96 4000K IP20	matný	9,6	840
51512906	KM15-B-M-96 6000K IP20	matný	9,6	840
51513903	KM15-B-TK-96 3000K IP20	číry klik	9,6	840
51513904	KM15-B-TK-96 4000K IP20	číry klik	9,6	840
51513906	KM15-B-TK-96 6000K IP20	číry klik	9,6	840
51514903	KM15-B-MK-96 3000K IP20	matný klik	9,6	840
51514904	KM15-B-MK-96 4000K IP20	matný klik	9,6	840
51514906	KM15-B-MK-96 6000K IP20	matný klik	9,6	840
51510103	KM15-B-T-125 3000K IP20	číry	12,5	1320
51510104	KM15-B-T-125 4000K IP20	číry	12,5	1320
51510106	KM15-B-T-125 6000K IP20	číry	12,5	1320
51511103	KM15-B-S-125 3000K IP20	mrazený	12,5	1320
51511104	KM15-B-S-125 4000K IP20	mrazený	12,5	1320
51511106	KM15-B-S-125 6000K IP20	mrazený	12,5	1320
51512103	KM15-B-M-125 3000K IP20	matný	12,5	1320
51512104	KM15-B-M-125 4000K IP20	matný	12,5	1320
51512106	KM15-B-M-125 6000K IP20	matný	12,5	1320
51513103	KM15-B-TK-125 3000K IP20	číry klik	12,5	1320
51513104	KM15-B-TK-125 4000K IP20	číry klik	12,5	1320
51513106	KM15-B-TK-125 6000K IP20	číry klik	12,5	1320
51514103	KM15-B-MK-125 3000K IP20	matný klik	12,5	1320
51514104	KM15-B-MK-125 4000K IP20	matný klik	12,5	1320
51514106	KM15-B-MK-125 6000K IP20	matný klik	12,5	1320

LED sada obsahuje lištu, kryt, koncovky, príchytky, LED pás a konektor 2.1,5.5 Y alebo kábel 2x0,35mm<sup>2</sup> v závislosti od použitého napájacieho zdroja.

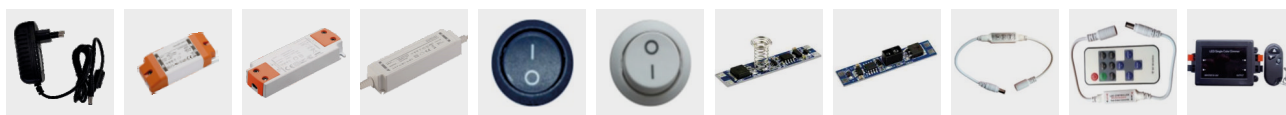

Najpoužívanejšie príslušenstvo

## Napájací zdroj

obj. kód	typ	Vypínač	W	V
30310024	KMA-24-12	nie	24	12
30310036	KMA-36-12	nie	36	12
30310060	KMA-60-12	nie	60	12
30510012	KMM-12-12	-	12	12
30610020	KMC-20-15	-	20	12
30810024	KMV-24-12	-	24	12
30810040	KMV-40-12	-	40	12

## Vypínače

obj. kód	typ	W	V
20323061	Vypínač 250V, 6A, čierny	1500	250
20323060	Vypínač 250V, 6A, biely	1500	250
20312145	Vypínač dotykový KM-VD-02L	96/192	12/24
20312155	Vypínač bezdotykový KM-VB-02L	96/192	12/24

## Stmievacie

obj. kód	obj. kód	W	V
38443071	Stmievateľ manuál 72-144W	72-144	12-24
38443072	Stmievateľ 72-144W	72-144	12-24
38443096	Stmievateľ 96-192W	96-192	12-24

## KM15-B

materiál:  
hliník, plast  
LED pás

12 V

30000 h



Ra>90



# LED sady

Možnosť výroby na mieru do 200 cm

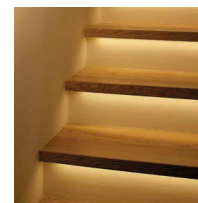
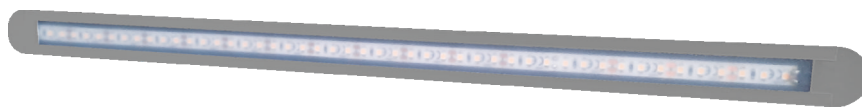

KM15-S, strieborná

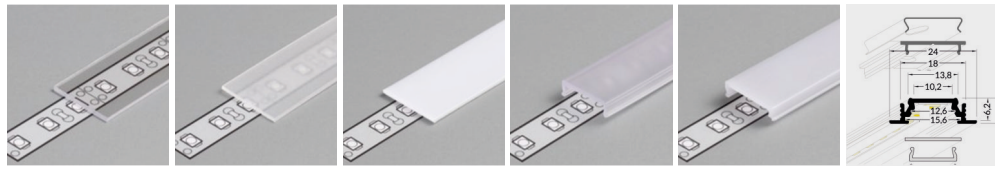

13-T, kryt číry

13-S, kryt mrazený

13-M, kryt matný

13-TK, klik číry

13-MK, klik matný

## LED sada

obj. kód	typ	kryt	W/m	lm/m
51500403	KM15-S-T-48 3000K IP20	číry	4,8	420
51500404	KM15-S-T-48 4000K IP20	číry	4,8	420
51500406	KM15-S-T-48 6000K IP20	číry	4,8	420
51501403	KM15-S-S-48 3000K IP20	mrazený	4,8	420
51501404	KM15-S-S-48 4000K IP20	mrazený	4,8	420
51501406	KM15-S-S-48 6000K IP20	mrazený	4,8	420
51502403	KM15-S-M-48 3000K IP20	matný	4,8	420
51502404	KM15-S-M-48 4000K IP20	matný	4,8	420
51502406	KM15-S-M-48 6000K IP20	matný	4,8	420
51503403	KM15-S-TK-48 3000K IP20	číry klik	4,8	420
51503404	KM15-S-TK-48 4000K IP20	číry klik	4,8	420
51503406	KM15-S-TK-48 6000K IP20	číry klik	4,8	420
51504403	KM15-S-MK-48 3000K IP20	matný klik	4,8	420
51504404	KM15-S-MK-48 4000K IP20	matný klik	4,8	420
51504406	KM15-S-MK-48 6000K IP20	matný klik	4,8	420
51500603	KM15-S-T-6 3000K IP20	číry	6	660
51500604	KM15-S-T-6 4000K IP20	číry	6	660
51500606	KM15-S-T-6 6000K IP20	číry	6	660
51501603	KM15-S-S-6 3000K IP20	mrazený	6	660
51501604	KM15-S-S-6 4000K IP20	mrazený	6	660
51501606	KM15-S-S-6 6000K IP20	mrazený	6	660
51502603	KM15-S-M-6 3000K IP20	matný	6	660
51502604	KM15-S-M-6 4000K IP20	matný	6	660
51502606	KM15-S-M-6 6000K IP20	matný	6	660
51503603	KM15-S-TK-6 3000K IP20	číry klik	6	660
51503604	KM15-S-TK-6 4000K IP20	číry klik	6	660
51503606	KM15-S-TK-6 6000K IP20	číry klik	6	660
51504603	KM15-S-MK-6 3000K IP20	matný klik	6	660
51504604	KM15-S-MK-6 4000K IP20	matný klik	6	660
51504606	KM15-S-MK-6 6000K IP20	matný klik	6	660

## LED sada

obj. kód	typ	kryt	W/m	lm/m
51500903	KM15-S-T-96 3000K IP20	číry	9,6	840
51500904	KM15-S-T-96 4000K IP20	číry	9,6	840
51500906	KM15-S-T-96 6000K IP20	číry	9,6	840
51501903	KM15-S-S-96 3000K IP20	mrazený	9,6	840
51501904	KM15-S-S-96 4000K IP20	mrazený	9,6	840
51501906	KM15-S-S-96 6000K IP20	mrazený	9,6	840
51502903	KM15-S-M-96 3000K IP20	matný	9,6	840
51502904	KM15-S-M-96 4000K IP20	matný	9,6	840
51502906	KM15-S-M-96 6000K IP20	matný	9,6	840
51503903	KM15-S-TK-96 3000K IP20	číry klik	9,6	840
51503904	KM15-S-TK-96 4000K IP20	číry klik	9,6	840
51503906	KM15-S-TK-96 6000K IP20	číry klik	9,6	840
51504903	KM15-S-MK-96 3000K IP20	matný klik	9,6	840
51504904	KM15-S-MK-96 4000K IP20	matný klik	9,6	840
51504906	KM15-S-MK-96 6000K IP20	matný klik	9,6	840
51500103	KM15-S-T-125 3000K IP20	číry	12,5	1320
51500104	KM15-S-T-125 4000K IP20	číry	12,5	1320
51500106	KM15-S-T-125 6000K IP20	číry	12,5	1320
51501103	KM15-S-S-125 3000K IP20	mrazený	12,5	1320
51501104	KM15-S-S-125 4000K IP20	mrazený	12,5	1320
51501106	KM15-S-S-125 6000K IP20	mrazený	12,5	1320
51502103	KM15-S-M-125 3000K IP20	matný	12,5	1320
51502104	KM15-S-M-125 4000K IP20	matný	12,5	1320
51502106	KM15-S-M-125 6000K IP20	matný	12,5	1320
51503103	KM15-S-TK-125 3000K IP20	číry klik	12,5	1320
51503104	KM15-S-TK-125 4000K IP20	číry klik	12,5	1320
51503106	KM15-S-TK-125 6000K IP20	číry klik	12,5	1320
51504103	KM15-S-MK-125 3000K IP20	matný klik	12,5	1320
51504104	KM15-S-MK-125 4000K IP20	matný klik	12,5	1320
51504106	KM15-S-MK-125 6000K IP20	matný klik	12,5	1320

LED sada obsahuje lištu, kryt, koncovky, príchytky, LED pás a konektor 2.1,5.5 Y alebo kábel 2x0,35mm<sup>2</sup> v závislosti od použitého napájacieho zdroja.



Najpoužívanejšie príslušenstvo

## KM15-S

materiál:  
hliník, plast  
LED pás

12 V

30000 h



Ra>90

### Napájací zdroj

obj. kód	typ	Vypínač	W	V
30310024	KMA-24-12	nie	24	12
30310036	KMA-36-12	nie	36	12
30310060	KMA-60-12	nie	60	12
30510012	KMM-12-12	-	12	12
30610020	KMC-20-15	-	20	12
30810024	KMV-24-12	-	24	12
30810040	KMV-40-12	-	40	12

### Vypínače

obj. kód	typ	W	V
20323061	Vypínač 250V, 6A, čierny	1500	250
20323060	Vypínač 250V, 6A, biely	1500	250
20312145	Vypínač dotykový KM-VD-02L	96/192	12/24
20312155	Vypínač bezdotykový KM-VB-02L	96/192	12/24

### Stmievače

obj. kód	obj. kód	W	V
38443071	Stmievač manuál 72-144W	72-144	12-24
38443072	Stmievač 72-144W	72-144	12-24
38443096	Stmievač 96-192W	96-192	12-24

# LED schodiskové

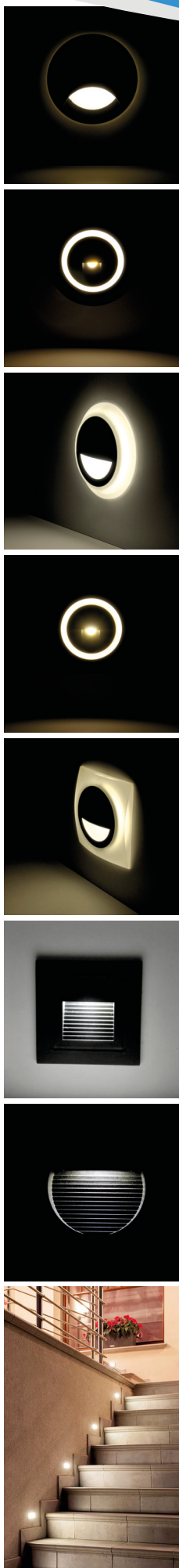

Q1-R 3W 4000K  
Obj. kód 313676



Q2-R 3W 4000K  
Obj. kód 313683



Q3-R 3W 4000K  
Obj. kód 313690

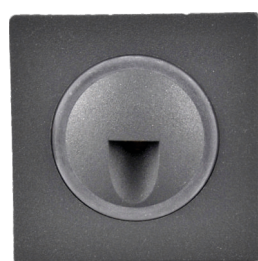

Q4-S 3W 4000K  
Obj. kód 313706



Q5-S 3W 4000K  
Obj. kód 313713

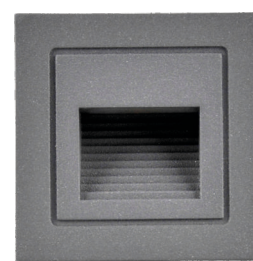

Q6-S 3W 4000K  
Obj. kód 313720

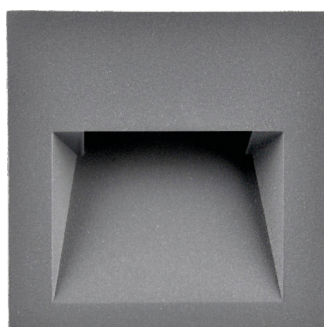

Q7-S 3W 4000K  
Obj. kód 313737



Q8-R 3W 4000K  
Obj. kód 313744



Q9-S 3W 4000K  
Obj. kód 313751



obj. kód	typ	farba	lm	farba svetla	rozmer (mm)	mont. otvor
313676	Q1-R 3W 4000K	biela	40	neutrálina	D60x59	D55
313683	Q2-R 3W 4000K	grafit	20	neutrálina	D60x59	D55
313690	Q3-S 3W 4000K	grafit	20	neutrálina	60x60x51	D55
313706	Q4-R 3W 4000K	grafit	40	neutrálina	D60x54	D55
313713	Q5-S 3W 4000K	grafit	40	neutrálina	60x60x54	D55
313720	Q6-S 3W 4000K	grafit	20	neutrálina	60x60x47	46x46
313737	Q7-S 3W 4000K	grafit	55	neutrálina	90x90x43	85x85
313744	Q8-R 3W 4000K	grafit	60	neutrálina	D95x18	-
313751	Q9-S 3W 4000K	grafit	50	neutrálina	90x90x18	-

**Q-R**  
**Q-S**

materiál:  
hliník

LED

3 W

50/60 Hz

220-240 V

4000 K

25000 h

IP 20





## LED schodiskové/panely

### ZIKO

materiál:  
kov, plast

LED

1,5 W

30 lm

12 V DC

4000 K

20000 h

IP 20



ZIKO KM1801-BL



ZIKO KM1802-CN



ZIKO KM1803-NK



Príslušenstvo: KRABICA D60  
Obj. kód 74560902

obj. kód	typ	farba	farba svetla	rozmer (mm)	mont. otvor
62601801	ZIKO KM1801-BL	biela	neutrálna	73x73x29	D60
62601802	ZIKO KM1802-CN	čierna	neutrálna	73x73x29	D60
62601803	ZIKO KM1803-NK	brúsený nikel	neutrálna	73x73x29	D60



### HELEN-R

materiál:  
plast

LED

220- 240 V

50/60 Hz



30000 h

Ra>80

IP44  
IP 54



HELEN-R

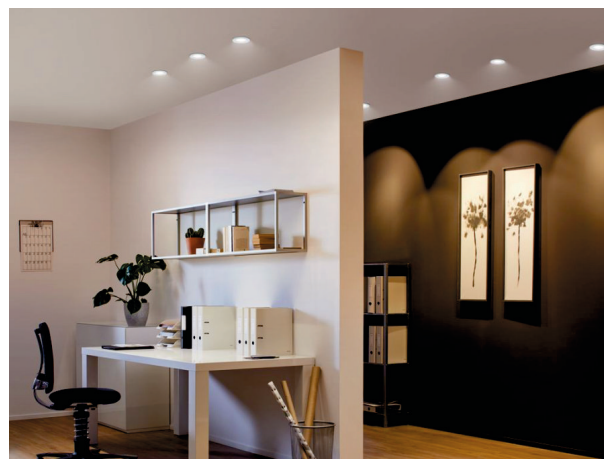

obj. kód	typ	W	lm	IP	farba	farba svetla	rozmer (mm)
2024360	HELEN-R 5W 3000K IP44	5	290	44	biela	teplá	D95x38
2027480	HELEN-R 5W 4000K IP54	5	425	54	biela	neutrálna	D95x24,5
2027490	HELEN-R 5W 6000K IP54	5	425	54	biela	studená	D95x24,5
2027500	HELEN-R 9W 4000K IP54	9	765	54	biela	neutrálna	D118x24,5
2027510	HELEN-R 9W 6000K IP54	9	765	54	biela	studená	D118x24,5
2027520	HELEN-R 18W 4000K IP54	18	1530	54	biela	neutrálna	D170x24,5
2027530	HELEN-R 18W 6000K IP54	18	1530	54	biela	studená	D170x24,5



# LED panely



LENA-RX

## LENA-RX

materiál:  
kov, plast

LED

180-240 V

50 Hz



50000 h

Ra>80

IP 20



obj. kód	typ	W	farba	lm	farba svetla	rozmer (mm)	mont. otvor
2023880	LENA-RX 3W 3000K	3	biela	270	teplá	D80x20	D70
2023890	LENA-RX 3W 4000K	3	biela	285	neutrálna	D80x20	D70
2023900	LENA-RX 3W 6000K	3	biela	300	studená	D80x20	D70
2023910	LENA-RX 6W 3000K	6	biela	540	teplá	D120x20	D105
2023920	LENA-RX 6W 4000K	6	biela	570	neutrálna	D120x20	D105
2023930	LENA-RX 6W 6000K	6	biela	600	studená	D120x20	D105
2023940	LENA-RX 12W 3000K	12	biela	1080	teplá	D168x20	D155
2023950	LENA-RX 12W 4000K	12	biela	1140	neutrálna	D168x20	D155
2023960	LENA-RX 12W 6000K	12	biela	1200	studená	D168x20	D155
2023970	LENA-RX 18W 3000K	18	biela	1620	teplá	D225x20	D205
2023980	LENA-RX 18W 4000K	18	biela	1710	neutrálna	D225x20	D205
2023990	LENA-RX 18W 6000K	18	biela	1800	studená	D225x20	D205
2024000	LENA-RX 24W 3000K	24	biela	2160	teplá	D300x20	D280
2024010	LENA-RX 24W 4000K	24	biela	2280	neutrálna	D300x20	D280
2024020	LENA-RX 24W 6000K	24	biela	2400	studená	D300x20	D280



LENA-SX

## LENA-SX

materiál:  
kov, plast

LED

180-240 V

50 Hz



50000 h

Ra>80

IP 20



obj. kód	typ	W	farba	lm	farba svetla	rozmer (mm)	mont. otvor
2022330	LENA-SX 3W 3000K	3	biela	270	teplá	85x85x20	73x73
2024040	LENA-SX 3W 4000K	3	biela	285	neutrálna	85x85x20	73x73
2024050	LENA-SX 3W 6000K	3	biela	300	studená	85x85x20	73x73
2024060	LENA-SX 6W 3000K	6	biela	540	teplá	118x118x20	106x106
2024070	LENA-SX 6W 4000K	6	biela	570	neutrálna	118x118x20	106x106
2024080	LENA-SX 6W 6000K	6	biela	600	studená	118x118x20	106x106
2024090	LENA-SX 12W 3000K	12	biela	1080	teplá	168x168x20	154x154
2024100	LENA-SX 12W 4000K	12	biela	1140	neutrálna	168x168x20	154x154
2024110	LENA-SX 12W 6000K	12	biela	1200	studená	168x168x20	154x154
2024120	LENA-SX 18W 3000K	18	biela	1620	teplá	221x221x20	204x204
2024130	LENA-SX 18W 4000K	18	biela	1710	neutrálna	221x221x20	204x204
2024140	LENA-SX 18W 6000K	18	biela	1800	studená	221x221x20	204x204
2024150	LENA-SX 24W 3000K	24	biela	2160	teplá	296x296x20	276x276
2024160	LENA-SX 24W 4000K	24	biela	2280	neutrálna	296x296x20	276x276
2024170	LENA-SX 24W 6000K	24	biela	2400	studená	296x296x20	276x276



## LED panely

### LENA-RG

materiál:  
kov, sklo

LED

180-240 V

50 Hz



50000 h

Ra>80

IP 20



LENA-RG

obj. kód	typ	W	farba	lm	farba svetla	rozmer (mm)	mont. otvor
2023400	LENA-RG 6W 3000K	6	biela	540	teplá	D99x40	D70
2023410	LENA-RG 6W 4000K	6	biela	570	neutrálna	D99x40	D70
2023420	LENA-RG 6W 6000K	6	biela	600	studená	D99x40	D70
2023430	LENA-RG 12W 3000K	12	biela	1080	teplá	D160x40	D125
2023440	LENA-RG 12W 4000K	12	biela	1140	neutrálna	D160x40	D125
2023450	LENA-RG 12W 6000K	12	biela	1200	studená	D160x40	D125
2023460	LENA-RG 16W 3000K	16	biela	1440	teplá	D200x40	D165
2023470	LENA-RG 16W 4000K	16	biela	1520	neutrálna	D200x40	D165
2023480	LENA-RG 16W 6000K	16	biela	1600	studená	D200x40	D165



### LENA-SG

materiál:  
kov, sklo

LED

180-240 V

50 Hz



50000 h

Ra>80

IP 20



LENA-SG

obj. kód	typ	W	farba	lm	farba svetla	rozmer (mm)	mont. otvor
2020331	LENA-SG 6W 3000K	6	biela	540	teplá	99x99x40	75x75
2023500	LENA-SG 6W 4000K	6	biela	570	neutrálna	99x99x40	75x75
2023510	LENA-SG 6W 6000K	6	biela	600	studená	99x99x40	75x75
2023520	LENA-SG 12W 3000K	12	biela	1080	teplá	160x160x40	125x125
2023530	LENA-SG 12W 4000K	12	biela	1140	neutrálna	160x160x40	125x125
2023540	LENA-SG 12W 6000K	12	biela	1200	studená	160x160x40	125x125
2023550	LENA-SG 16W 3000K	16	biela	1440	teplá	200x200x40	165x165
2023560	LENA-SG 16W 4000K	16	biela	1520	neutrálna	200x200x40	165x165
2023570	LENA-SG 16W 6000K	16	biela	1600	studená	200x200x40	165x165



# LED panely



LINA-R



## LINA-R

materiál:  
plast

LED

220-240 V

50/60 Hz



30000 h

Ra>85

IP 20



obj. kód	typ	W	farba	lm	K	farba svetla	rozmer (mm)
2027160	LINA-R 3W 4000K	3	biela	330	4000	neutrálna	D91x28
2027170	LINA-R 3W 6000K	3	biela	330	6000	studená	D91x28
2027180	LINA-R 6W 4000K	6	biela	660	4000	neutrálna	D121x28,4
2027190	LINA-R 6W 6000K	6	biela	660	6000	studená	D121x28,4
2027200	LINA-R 12W 4000K	12	biela	1320	4000	neutrálna	D171x28,4
2027210	LINA-R 12W 6000K	12	biela	1320	6000	studená	D171x28,4
2027220	LINA-R 18W 4000K	18	biela	1980	4000	neutrálna	D221x28,9
2027230	LINA-R 18W 6000K	18	biela	1980	6000	studená	D221x28,9
2027240	LINA-R 24W 4000K	24	biela	2640	4000	neutrálna	D291x29,1
2027250	LINA-R 24W 6000K	24	biela	2640	6000	studená	D291x29,1



LINA-S



## LINA-S

materiál:  
plast

LED

220-240 V

50/60 Hz



30000 h

Ra>85

IP 20



obj. kód	typ	W	farba	lm	K	farba svetla	rozmer (mm)
2027260	LINA-S 3W 4000K	3	biela	330	4000	neutrálna	90,2x90,2x28,2
2027270	LINA-S 3W 6000K	3	biela	330	6000	studená	90,2x90,2x28,2
2027280	LINA-S 6W 4000K	6	biela	660	4000	neutrálna	121x121x28,4
2027290	LINA-S 6W 6000K	6	biela	660	6000	studená	121x121x28,4
2027300	LINA-S 12W 4000K	12	biela	1320	4000	neutrálna	171x171x28,4
2027310	LINA-S 12W 6000K	12	biela	1320	6000	studená	171x171x28,4
2027320	LINA-S 18W 4000K	18	biela	1980	4000	neutrálna	221x221x28,8
2027330	LINA-S 18W 6000K	18	biela	1980	6000	studená	221x221x28,8
2027340	LINA-S 24W 4000K	24	biela	2640	4000	neutrálna	295x295x28,6
2027350	LINA-S 24W 6000K	24	biela	2640	6000	studená	295x295x28,6





# LED panely

## DARIA

materiál:  
kov, plast

LED

85- 265 V

50 Hz



20000 h

Ra>80

IP 44



DARIA



obj. kód	typ	W	farba	lm	farba svetla	rozmer (mm)
2025510	DARIA 18W 4000K IP44	18	biela	1872	neutrálna	D120 x 32
2025520	DARIA 18W 6500K IP44	18	biela	1908	studená	D120 x 32
2025540	DARIA 24W 4000K IP44	24	biela	2544	neutrálna	D170 x 35
2025550	DARIA 24W 6500K IP44	24	biela	2592	studená	D170 x 35
2025570	DARIA 36W 4000K IP44	36	biela	3888	neutrálna	D225 x 35
2025580	DARIA 36W 6500K IP44	36	biela	3960	studená	D225 x 35



## HDC

materiál:  
plast

LED

180- 260 V

50 Hz



25000 h

Ra>80

IP 20



HDC



obj. kód	typ	W	farba	lm	farba svetla	rozmer (mm)
62703124	HDC12RN 12W 4000K	12	biela	1200	neutrálna	D166x18
62703126	HDC12RC 12W 6000K	12	biela	1200	studená	D166x18
62703184	HDC18RN 18W 4000K	18	biela	1800	neutrálna	D220x18
62703186	HDC18RC 18W 6000K	18	biela	1800	studená	D220x16



# LED panely



LINDA-R

## LINDA-R

materiál:  
kov, plast

LED

185-240 V

50 Hz



50000 h

Ra>80

IP 20



obj. kód	typ	W	farba	lm	farba svetla	rozmer (mm)
2023640	LINDA-R 12W 3000K	12	biela	1080	teplá	D173x35
2023650	LINDA-R 12W 4000K	12	biela	1140	neutrálina	D173x35
2023660	LINDA-R 12W 6000K	12	biela	1200	studená	D173x35
2023670	LINDA-R 20W 3000K	20	biela	1800	teplá	D225x37
2023680	LINDA-R 20W 4000K	20	biela	1900	neutrálina	D225x37
2023690	LINDA-R 20W 6000K	20	biela	2000	studená	D225x37
2023700	LINDA-R 24W 3000K	24	biela	1920	teplá	D300x37
2023710	LINDA-R 24W 4000K	24	biela	2280	neutrálina	D300x37
2023720	LINDA-R 24W 6000K	24	biela	2400	studená	D300x37



LINDA-S

## LINDA-S

materiál:  
kov, plast

LED

185-240 V

50 Hz



50000 h

Ra>80

IP 20



obj. kód	typ	W	farba	lm	farba svetla	rozmer (mm)
2023790	LINDA-S 12W 3000K	12	biela	1080	teplá	173x173x35
2023800	LINDA-S 12W 4000K	12	biela	1140	neutrálina	173x173x35
2023810	LINDA-S 12W 6000K	12	biela	1200	studená	173x173x35
2023820	LINDA-S 20W 3000K	20	biela	1800	teplá	223x223x37
2023830	LINDA-S 20W 4000K	20	biela	1900	neutrálina	223x223x37
2023840	LINDA-S 20W 6000K	20	biela	2000	studená	223x223x37
2023850	LINDA-S 24W 3000K	24	biela	1920	teplá	298x298x37
2023860	LINDA-S 24W 4000K	24	biela	2280	neutrálina	298x298x37
2023870	LINDA-S 24W 6000K	24	biela	2400	studená	298x298x37





# LED panely

## LARA-R

materiál:  
plast

LED

220-240 V

50/60 Hz



30000 h

Ra>85

IP 20



LARA-R



obj. kód	typ	W	farba	lm	farba svetla	rozmer (mm)
2027360	LARA-R 12W 4000K	12	biela	1320	neutrálina	D167x30,7
2027370	LARA-R 12W 6000K	12	biela	1320	studená	D167x30,7
2027380	LARA-R 18W 4000K	18	biela	1980	neutrálina	D216x30,8
2027390	LARA-R 18W 6000K	18	biela	1980	studená	D216x30,8
2027400	LARA-R 24W 4000K	24	biela	2640	neutrálina	D289x31,2
2027410	LARA-R 24W 6000K	24	biela	2640	studená	D289x31,2



## LARA-S

materiál:  
plast

LED

220-240 V

50/60 Hz



30000 h

Ra>85

IP 20



LARA-S



obj. kód	typ	W	farba	lm	farba svetla	rozmer (mm)
2027420	LARA-S 12W 4000K	12	biela	1320	neutrálina	167,3x167,3x30,7
2027430	LARA-S 12W 6000K	12	biela	1320	studená	167,3x167,3x30,7
2027440	LARA-S 18W 4000K	18	biela	1980	neutrálina	214x214x31
2027450	LARA-S 18W 6000K	18	biela	1980	studená	214x214x31
2027460	LARA-S 24W 4000K	24	biela	2640	neutrálina	287x287x30,7
2027470	LARA-S 24W 6000K	24	biela	2640	studená	287x287x30,7



## VENUS-BC

materiál:  
kov, plast

LED

220-240 V

50/60 Hz



50000 h

Ra>83

IP 20

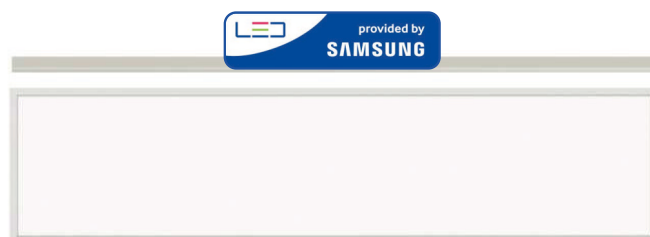

Panel LED VENUS-BC

### LED panel

obj. kód	typ	W	lm	farba svetla	farba	rozmer (mm)
2429940	VENUS BC 48W 120X30CM 4000K	48	5187	neutrálina	biela	1200x300
2429950	VENUS BC 48W 120X30CM 6500K	48	5280	studená	biela	1200x300



VENUS BC 48W

## VENUS

materiál:  
hliník, plast

LED

175-255 V

50 Hz



Ra>80

50000 h

IP 20



### LED panel

obj. kód	typ	W	lm	farba svetla	farba	rozmer (mm)
2424130	VENUS BC 48W 4000K	48	4250	neutrálina	biela	595x595
2424140	VENUS BC 48W 6500K	48	4320	studená	biela	595x595





# LED panely

## SURYA

materiál:  
hliník, plast

LED

50/60 Hz



Ra>80

4200 K

IP 20

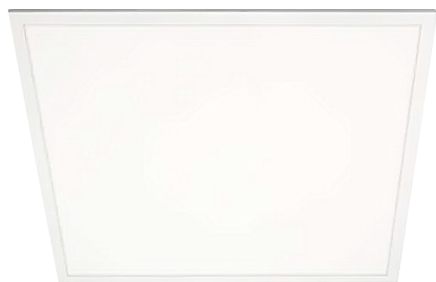

LED panel 600 x 600



Napájací zdroj

### LED panel - bez napájacieho zdroja

obj. kód	typ	W	U	lm	životnosť	farba	rozmer (mm)
2412391	SURYA 40W 4200K 10P	40	185-265 V	3120	30000 h	biela	595x595x8

### Napájací zdroj - dodávaný samostatne

obj. kód	typ	W	U	farba	rozmer (mm)
6200050	SURYA 40W	40	185-265 V	biela, modrá	90x35x20

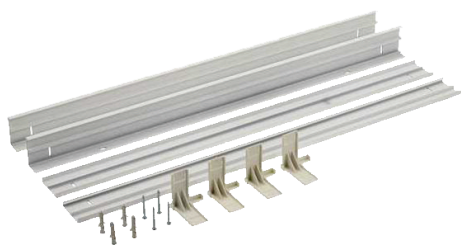

Rám pre LED panel



Záves



Úchyt

## PRÍSLUŠENSTVO VENUS, SURYA

materiál:  
hliník, plast

### Príslušenstvo

obj. kód	typ	montáž	farba	materiál
9901212	PANELFIX-S - rám 600x600	povrchová	biela	kov
9901230	PANELFIX-P - záves, set 4 ks	závesná	šedá	kov
9901240	PANELFIX-C - úchyt, set 4 ks	do sadrokartónu	šedá	kov

Záruka  
**5**  
rokov

provided by  
**SAMSUNG**

<19  
UGR



ZAGREY

## ZAGREY

materiál:  
kov, plast

LED

36 W

170-265 V

50/60 Hz



50000 h



Ra>80



IP 20

### LED panel

obj. kód	typ	lm	farba svetla	farba	rozmer (mm)
2430010	ZAGREY 36W 4000K 60X60 URG<19 5Y	4680	neutrálina	biela	600x600
2430020	ZAGREY 36W 6500K 60X60 URG<19 5Y	5040	studená	biela	600x600





# LED panely

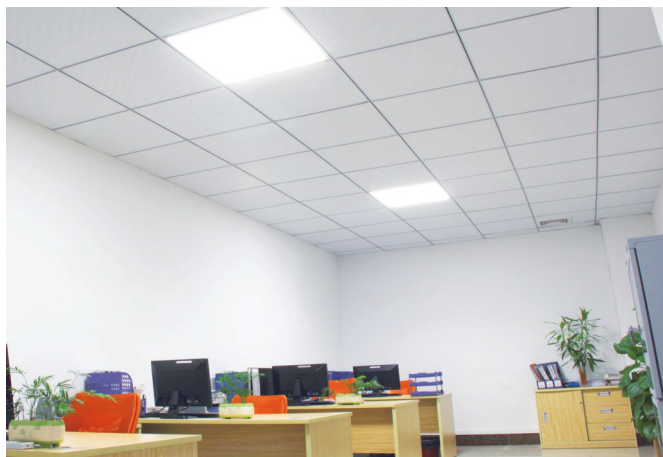

LED panel 600 x 600



LED panel 600 x 600 prísadený



HPB4060-40W 60x60

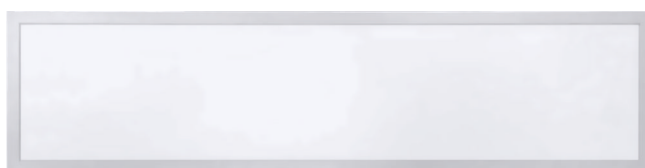

LED panel 300 x 1200



Rám pre LED panel



Úchyt



Záves

## LED PANEL

materiál:  
kov, plast

LED

50 Hz



Ra>80

4000 K

IP 20



### LED panel

obj. kód	typ	W	U	lm	životnosť	rozmer (mm)
62700340	HPL4060 40W	40	175-265 V	4400	20000 h	600x600
62700341	LOR4060ST 40W	40	220-240 V	4400	25000 h	600x600
62700351	LOR40120ST 40W	40	220-240 V	4200	25000 h	300x1200
62700339	HPL4060-10, 40W 2-PACK	40	175-265 V	4400	20000 h	600x600
62700345	HPB4060SM-40W PRISADENÝ	40	175-265 V	4400	20000 h	600x600
62700342	HPB4060-40W 60x60	40	185-265 V	4400	35000 h	595x595x24

### Rám

obj. kód	typ	montáž	rozmer (mm)
62700357	LOP901W	povrchová	600x600
62700359	LOP902W	povrchová	300x1200

### Príslušenstvo

obj. kód	typ	montáž
62700365	LOP905 - úchyt, set 4 ks	do sadrokartónu
62700367	LOP903D - záves, set 4 ks	závesná





TRILINE-60 20W 4500K  
Obj. kód 3310760



TRILINE-120 40W 4500K  
Obj. kód 3310770



TRILINE-150 60W 4500K  
Obj. kód 3310780



obj. kód	typ	W	farba	lm	farba svetla	rozmer (mm)
3310760	TRILINE-60 20W 4500K	20	šedá	2400	neutrálna	600x70x55
3310770	TRILINE-120 40W 4500K	40	šedá	4800	neutrálna	1200x70x55
3310780	TRILINE-150 60W 4500K	60	šedá	7200	neutrálna	1500x70x55

## TRILINE

materiál:  
plast ABS & PC

LED

85-265 V

50/60 Hz

30000 h

Ra>80

IP 65

4000 K



Svietidlo DELFIA  
Obj. kód 62407020

## DELFINA

materiál:  
plast, kov

2x T8

LED

230 V

50 Hz

IP 20



obj. kód	typ	farba	rozmer (mm)
62700080	DELFINA 2X120CM T8 LED	biela, čirý difúzor	1265x120x55



## LED technické

### LINEA LHT

materiál: hliník, PC

LED

220-240 V

50/60 Hz

4000 K

25000 h

RA>80

IP 65

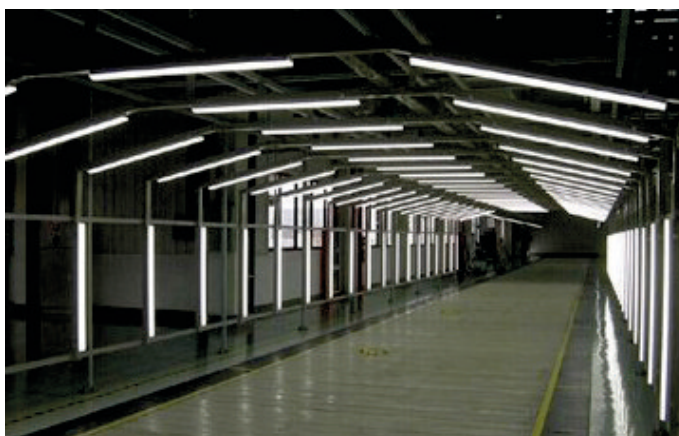

LINEA LHT



obj. kód	typ	W	lm	farba	rozmer (mm)
62700065	LHT071, 18W	18	2740	biela	644x78,5x41,5
62700066	LHT072, 36W	36	5778	biela	1244x78,5x41,5
62700067	LHT073, 48W	48	7700	biela	1544x78,5x41,5



### KROS

materiál: PC

LED

185-265 V

50/60 Hz

4000 K

30000 h

RA>80

IP 65

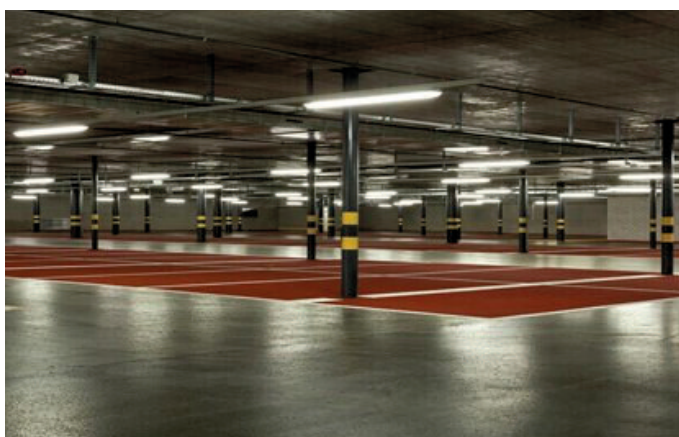

KROS KM3060-18W, obj. kód. 62306018  
KROS KM3060-36W, obj. kód. 62306036

obj. kód	typ	W	lm	farba	rozmer (mm)
62306018	KROS KM3060-18W	18	1500	biela	580x62x56
62306036	KROS KM3060-36W	36	3000	biela	1180x62x56





ZEBRA  
Obj. kód 62700085

obj. kód	typ	farba	rozmer (mm)
62700085	ZEBRA 2X120CM T8 LED	biela, difúzor chróm	1260x130x65

## ZEBRA

materiál:  
plast, kov

2x T8

LED

230 V

50 Hz

IP 20



HERMETIC-B 2X120CM T8 LED  
bez plechu



HERMETIC 2XT8 LED

obj. kód	typ	farba	kryt	rozmer (mm)
62700069	HERMETIC 2x60CM T8 LED	šedá	áno	82x94x670
62700070	HERMETIC 2x120CM T8 LED	šedá	áno	82x94x1270
62700071	HERMETIC 2x150CM T8 LED	šedá	áno	82x94x1570
62700075	HERMETIC-B 2x120CM T8 LED	šedá	nie	58x115x1280

## HERMETIC

materiál:  
plast, kov

2x T8

LED

230 V

50/60 Hz

IP 65





## LED technické

### HDS

materiál:  
plast

LED

220-240 V

50/60 Hz

25000 h

RA>80



110°

IP 44



HDS1502-15W 4000K, obj. kód 62700010  
HDS1503-15W 6500K, obj. kód 62700011  
HDS3002-30W 4000K, obj. kód 62700013  
HDS3003-30W 6500K, obj. kód 62700014

obj. kód	typ	W	lm	farba	rozmer (mm)
62700010	HDS1502-15W 4000K	15	1500	biela	580x76x25
62700011	HDS1503-15W 6500K	15	1500	biela	580x76x25
62700013	HDS3002-30W 4000K	30	3200	biela	1180x76x25
62700014	HDS3003-30W 6500K	30	3200	biela	1180x76x25



### HDS

materiál:  
plast

LED

36W

195-265 V

50/60 Hz

RA>80

20000 h



120°

IP 20

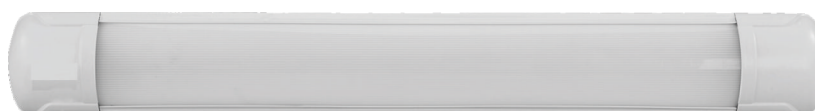
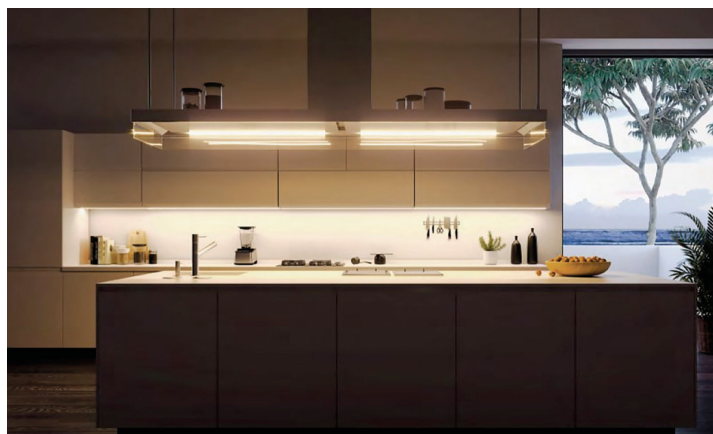

HDS3603-36W 6500K, obj. kód 62700021

obj. kód	typ	W	lm	farba	rozmer (mm)
62700021	HDS3603-36W 6500K	36	2880	biela	1192x75x26



# LED podlinkové

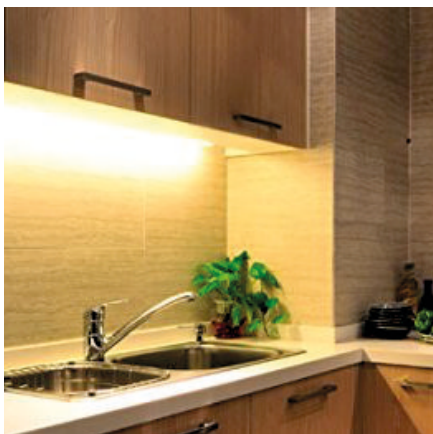

KM2016 BL  
KM2016 B BL



KM2016 SL  
KM2016 B SL

## KM2016

materiál: kov,  
plast, sklo

LED

230 V

50 Hz

Ra>80

4000 K

IP 20



obj. kód	typ	W	farba	lm	rozmer (mm)	pripojenie
62440350	KM2016-5W B BL	5	biela	400	347x35x85	na svorkovnicu
62440550	KM2016-10W B BL	10	biela	800	575x35x85	na svorkovnicu
62440900	KM2016-15W B BL	15	biela	1250	913x35x85	na svorkovnicu
62440351	KM2016-5W B SL	5	strieborná	400	347x35x85	na svorkovnicu
62440551	KM2016-10W B SL	10	strieborná	800	575x35x85	na svorkovnicu
62440901	KM2016-15W B SL	15	strieborná	1250	913x35x85	na svorkovnicu
62440352	KM2016-5W BL	5	biela	400	347x35x85	na kábel
62440552	KM2016-10W BL	10	biela	800	575x35x85	na kábel
62440902	KM2016-15W BL	15	biela	1250	913x35x85	na kábel
62440353	KM2016-5W SL	5	strieborná	400	347x35x85	na kábel
62440553	KM2016-10W SL	10	strieborná	800	575x35x85	na kábel
62440903	KM2016-15W SL	15	strieborná	1250	913x35x85	na kábel

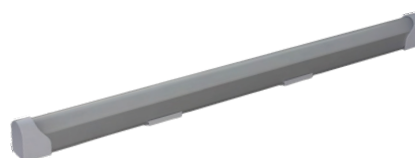
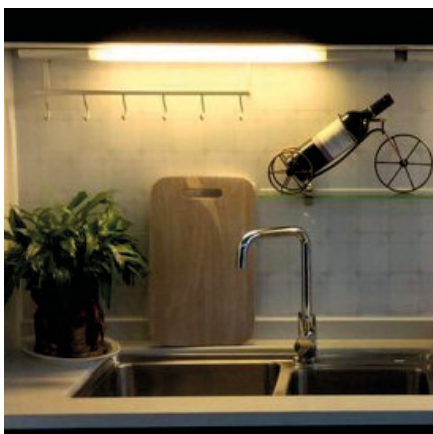

KM4009-10W  
Obj. kód 62407010



KM4009-15W  
Obj. kód 62407015

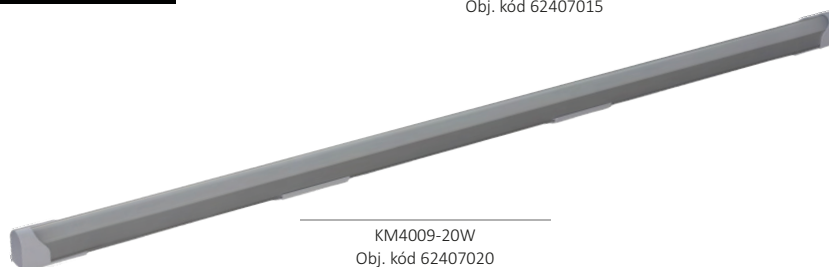

KM4009-20W  
Obj. kód 62407020

## KM4009

materiál:  
kov, plast

LED

230 V

50 Hz

Ra>80

4000 K

IP 20



obj. kód	typ	W	farba	lm	rozmer (mm)	pripojenie
62407010	KM4009-10W	10	strieborná	850	600x29x44	na svorkovnicu
62407015	KM4009-15W	15	strieborná	1300	900x29x44	na svorkovnicu
62407020	KM4009-20W	20	strieborná	1700	1200x29x44	na svorkovnicu





# LED podlinkové

## FIT-A

materiál:  
hliník, plast

LED

220-240 V

50/60 Hz



6400 K

IP 20

30000 h

Ra>83

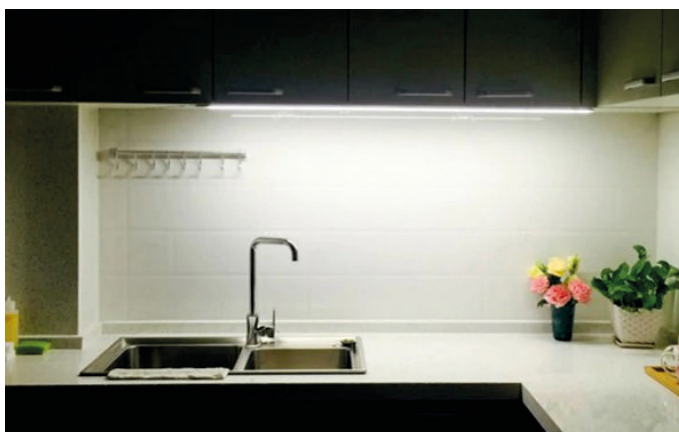

FIT-A 18W 6400K  
Obj. kód 2313380



FIT-A 36W 6400K  
Obj. kód 2313360

obj. kód	typ	W	lm	farba	rozmer (mm)
2313380	FIT-A 18W 6400K	18	1836	biela	76x590
2313360	FIT-A 36W 6400K	36	3672	biela	76x1180



## KM4007

materiál: plast

LED

170-260 V

50 Hz



4500 K

40000 h

Ra>80

IP 20



KM4007-9W, obj. kód. 62400709



KM4007-18W, obj. kód. 62400718



KM4007-26W, obj. kód. 62400726



KM4007-36W, obj. kód. 62400736

obj. kód	typ	W	lm	farba	rozmer (mm)
62400709	KM4007-9W	9	810	biela	305x75x25
62400718	KM4007-18W	18	1620	biela	630x75x25
62400726	KM4007-26W	26	2080	biela	940x75x25
62400736	KM4007-36W	36	3240	biela	1235x75x25



# LED podlinkové

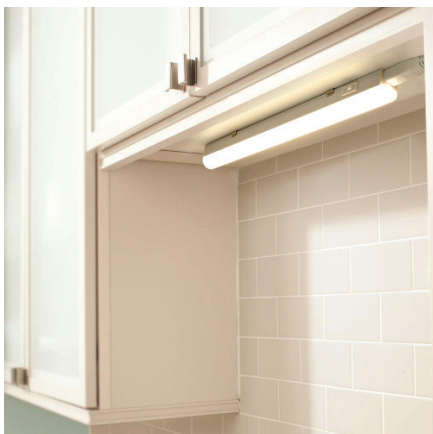

KM4004-4W  
Obj. kód 62400404



KM4004-9W  
Obj. kód 62400408



KM4004-13W  
Obj. kód 62400410

## KM4004

materiál:  
plast

LED

240 V

50 Hz

Ra>80

4000 K

IP 20



obj. kód	typ	W	farba	lm	rozmer (mm)	pripojenie
62400404	KM4004-4W	4	biela	300	289x36x30	na kábel
62400408	KM4004-9W	9	biela	720	517x36x30	na kábel
62400410	KM4004-13W	13	biela	1050	850x36x30	na kábel





# Lampy

## VIOLA

materiál: plast

LED

5 V

4000 K

10000 h

IP 44

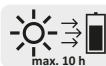

max. 10 h



2 h/200 lm

8 h/50 lm

30 h/10 lm

3,7 V 1200mAh  
Li-Ion

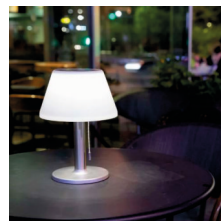

VIOLA LED 4000K  
Obj. kód 325457

obj. kód	typ	farba	lm	rozmer (mm)
325457	VIOLA LED 4000K	strieborná	10-50-200	D200x278

## BONO

materiál:  
kov, sklo

LED

3,4 W

450 lm

230 V

30000 h

4000 K



50 Hz



Ra>80



IP 20



BONO KM1180-NK  
Obj. kód 62010040



BONO tienidlo  
Obj. kód 62010045



BONO LED modul  
Obj. kód 62010047

obj. kód	typ	farba	rozmer (mm)
62010040	BONO KM1180-NK	nikel	D121x157
62010045	BONO TIENIDLO	opal	D120
62010047	BONO LED MODUL	biela	D33x23



# Lampy



ŽABA USB-AKU ZN  
Obj. kód 32722



PANDA USB-AKU CN  
Obj. kód 327215



ZAJAC USB-AKU MD  
Obj. kód 327048



ZAJAC USB-AKU RZ  
Obj. kód 327178

obj. kód	typ	farba	rozmer (mm)
327215	PANDA USB-AKU CN	čierno-biela	195x165x245
327222	ŽABA USB-AKU ZN	zelená	195x160x250
327048	ZAJAC USB-AKU MD	modrá	190x160x305
327178	ZAJAC USB-AKU RZ	ružová	190x160x305

## DETSKÉ

materiál:  
ABS, PP

LED

2,5 W

5 V DC  
USB C

3000 K  
teplá biela

20000 h

Li-ion 18650  
3,7V 1200 mAh

8h 30%, 6h 60%,  
4h 100%

IP20



Ra>80



## MACO

materiál:  
ABS, PP

LED

2,5 W

220-240 V

50/60 Hz

3000 K  
teplá biela

IP 20

Ra>80



MACO 308221 BL  
Obj. kód 308221



MACO 309907 RZ  
Obj. kód 309907



MACO-O 308252 MD  
Obj. kód 308252

obj. kód	typ	farba	rozmer (mm)
308221	MACO 308221 BL	biela	190x160x255
308252	MACO-O 308252 MD	modrá	210x195x255
309907	MACO 309907 RZ	ružová	235x160x245



lm  
10-30-70

## DETSKÉ RGB+W

materiál: plast

LED

2,5 W

220-240 V

50/60 Hz

4000 K  
+ RGB

IP 20

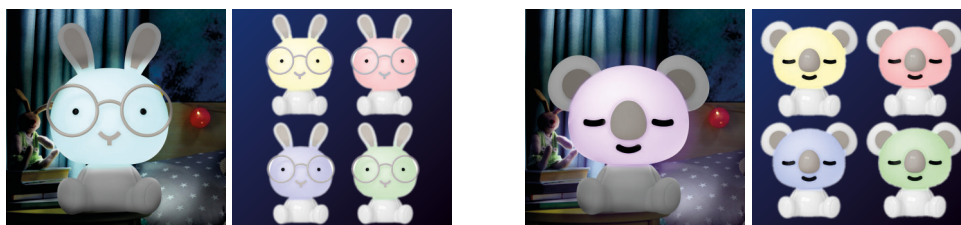

ZAJAC LED 2,5W RGB+W  
Obj. kód 325631



KOALA LED 2,5W RGB+W  
Obj. kód 325648

obj. kód	typ	farba	lm	farba svetla	rozmer (mm)
325631	ZAJAC LED 2,5W RGB+W	biela	110	neutrálna biela + RGB	D190x305
325648	KOALA LED 2,5W RGB+W	biela	110	neutrálna biela + RGB	D255x250

## USPÁVANKA

materiál:  
ABS, PC, tkanina

LED

RGB

5 V

timer

auto off

10 melódíí

IP 20



JEDNOROŽEC LED RGB  
Obj. kód 326737

ŽIRAFA LED RGB  
Obj. kód 326744

MACO LED RGB  
Obj. kód 326751

ZAJAC LED RGB  
Obj. kód 326768

PES LED RGB  
Obj. kód 326775

KOALA LKED RGB  
Obj. kód 326782

obj. kód	typ	farba	rozmer (mm)
326737	JEDNOROŽEC LED RGB	biela, ružová	115x9,5x20
326744	ŽIRAFA LED RGB	biela, žltá	115x9,5x20
326751	MACO LED RGB	biela, hnedá	115x9,5x20
326768	ZAJAC LED RGB	biela, ružová	115x9,5x20
326775	PES LED RGB	Biela, modrá, sivá	115x9,5x20
326782	KOALA LED RGB	biela, tyrkysová	115x9,5x20



MOON LED 1W 4000K-6500K-BLUE  
Obj. kód 312983

## MOON

materiál:  
plast, silikón

LED

1 W

5 V

4000 K  
6500 K  
+  
MODRÁ

IP 20



obj. kód	typ	farba	rozmer (mm)
312983	MOON LED 1W 4000K-6500K-BLUE	biela	129x129x117



MAX 12-15 h  
3000 K  
+ RGB

MACO 312952 BL SILIKON  
Obj. kód 312952



MAX 12-15 h  
3000 K  
+ RGB

MACO 312969 MD SILIKON  
Obj. kód 312969



MAX 12-15 h  
3000 K  
+ RGB

MACO 312976 RZ SILIKON  
Obj. kód 312976



MAX 6 h  
3000 K  
+ RGB

MACKA 3000K+RGB USB-C SILIKON  
Obj. kód 327642



MAX 10 h  
RGB

KAPIBARA RGB USB-C SILIKON  
Obj. kód 329004



MAX 6 h  
3000 K

PANDA 3000K USB-C SILIKON  
Obj. kód 327529

## SILIKON

materiál:  
plast, silikón

LED

5 V DC

IP 20

Ra>80



1200 mAh

obj. kód	typ	W	lm	farba svetla	farba	rozmer (mm)
312952	MACO 312952 BL SILIKON	0,8	max. 20	teplá biela + RGB	biela	D110x160
312969	MACO 312969 MD SILIKON	0,8	max. 20	teplá biela + RGB	modrá	D110x160
312976	MACO 312976 RZ SILIKON	0,8	max. 20	teplá biela + RGB	ružová	D110x160
327642	MACKA 3000K+RGB USB-C SILIKON	1	max. 59	teplá biela + RGB	biela, šedá, žltá	96x117x126
329004	KAPIBARA RGB USB-C SILIKON	1	max. 59	RGB	bežová, hnedá	98x114x116
327529	PANDA 3000K USB-C SILIKON	2	max.20	teplá biela	biela, čierna	109x100x110



# Lampy

## LOTUS

materiál: plast  
rozmer:  
175x375x220 mm

LED

6,5 W

480 lm

IP 20

230 V



25000 h



4000 K



50 Hz



KM1311-BL LOTUS  
Obj. kód 62010070



KM1311-CN LOTUS  
Obj. kód 62010071



KM1311-CV LOTUS  
Obj. kód 62010072



KM1311-ZT LOTUS  
Obj. kód 62010073



KM1311-MD LOTUS  
Obj. kód 62010074



KM1311-ST LOTUS  
Obj. kód 62010075

obj. kód	typ	farba
62010070	KM1311-BL LOTUS	biela
62010071	KM1311-CN LOTUS	čierna
62010072	KM1311-CV LOTUS	červená
62010073	KM1311-ZT LOTUS	zlatá
62010074	KM1311-MD LOTUS	modrá
62010075	KM1311-ST LOTUS	strieborná



## ZERA

materiál:  
kov, plast

GU10

10 W

230 V

50 Hz

IP 20



ZERA KM2609-BL  
Obj. kód 60402601



ZERA KM2609-CN  
Obj. kód 60402602

obj. kód	typ	farba	rozmer (mm)
60402601	ZERA KM2609-BL	biela	380x140x140
60402602	ZERA KM2609-CN	čierna	380x140x140

# Lampy



## PUPIL

materiál: plast



PUPIL-WH 6W 5V  
obj. kód 5301600

PUPIL-GR 6W 5V  
obj. kód 5301610

IP 20	<b>LED</b>
USB	6 W
Ra>80	150 lm
	5 V
	30000 h
	CCT 3000 K <input type="radio"/> 4000 K <input type="radio"/> 6400 K <input type="radio"/>



obj. kód	typ	farba	rozmer (mm)
5301600	PUPIL-WH 6W 5V	biela	340x136x100
5301610	PUPIL-GR 6W 5V	zelená	340x136x100



GAMA KM4010-BL  
Obj. kód 60401001



GAMA KM4010-CN  
Obj. kód 60401002



GAMA KM4010-ST  
Obj. kód 60401003



GAMA KM4010-CV  
Obj. kód 60401004



GAMA KM4010-MD  
Obj. kód 60401005



GAMA KM4010-ZN  
Obj. kód 60401006



GAMA KM4010-ZL  
Obj. kód 60401007



GAMA KM4010-RU  
Obj. kód 60401008



GAMA KM4010-MCH  
Obj. kód 60401009



GAMA KM4010-PT  
Obj. kód 60401010



GAMA KM4010-MP  
Obj. kód 60401011

obj. kód	typ	farba
60401001	GAMA KM4010-BL	biela
60401002	GAMA KM4010-CN	čierna
60401003	GAMA KM4010-ST	strieborná
60401004	GAMA KM4010-CV	červená
60401005	GAMA KM4010-MD	modrá
60401006	GAMA KM4010-ZN	zelená

obj. kód	typ	farba
60401007	GAMA KM4010-ZL	žltá
60401008	GAMA KM4010-RU	ružová
60401009	GAMA KM4010-MCH	matný chróm
60401010	GAMA KM4010-PT	patina
60401011	GAMA KM4010-MP	medená patina

## GAMA

materiál:  
kov, plast

E27
max. 60 W
220-240 V
50 Hz
IP 20



# Lampy

## BENTO

materiál:  
plast

LED

6,5 W

220-240 V

50/60 Hz



120°

25000 h

700 lm

CCT

3000 K

4000 K

6400 K



IP 20



BENTO KM2371-BL  
Obj. kód 62010120



BENTO KM2371-CN  
Obj. kód 62010121

obj. kód	typ	farba	rozmer (mm)
62010120	BENTO KM2371-BL	biela	370x318x130
62010121	BENTO KM2371-CN	čierna	370x318x130



## TOBI

materiál:  
kov, plast

E27

max. 12 W

230 V

50 Hz

IP 20



TOBI-BL E27 12W  
Obj. kód 60030820



TOBI-CN E27 12W  
Obj. kód 60030821



TOBI-MD E27 12W  
Obj. kód 60030822



TOBI-CV E27 12W  
Obj. kód 60030823



TOBI-ZN E27 12W  
Obj. kód 60030824



TOBI-RZ E27 12W  
Obj. kód 60030825

obj. kód	typ	farba
60030820	TOBI-BL E27 12W	biela
60030821	TOBI-CN E27 12W	čierna
60030822	TOBI-MD E27 12W	modrá
60030823	TOBI-CV E27 12W	červená
60030824	TOBI-ZN E27 12W	zelená
60030825	TOBI-RZ E27 12W	ružová



TUBA-K KM1931-BL  
Obj. kód 60401931



TUBA-K KM1931-CN  
Obj. kód 60401932

obj. kód	typ	farba	rozmer (mm)
60401931	TUBA-K KM1931-BL	biela	D71x100x405
60401932	TUBA-K KM1931-CN	čierna	D71x100x405

## TUBA-K

materiál:  
plast

GU 10

max. 9 W

230 V

50/60 Hz

IP 20



TUBA-S KM1932-BL  
Obj. kód 60401933



TUBA-S KM1932-CN  
Obj. kód 60401934

obj. kód	typ	farba	rozmer (mm)
60401933	TUBA-S KM1932-BL	biela	130x130x1200
60401934	TUBA-S KM1932-CN	čierna	130x130x1200

## TUBA-S

materiál:  
kov, plast

GU 10

max. 9 W

230 V

50/60 Hz

IP 20





# Lampy

## FERRARA

materiál:  
ABS, kov

LED

13 W

220-240 V

220-240 V

50/60 Hz

CCT  
3000-6500 K



IP 20

700 lm



Ra > 80

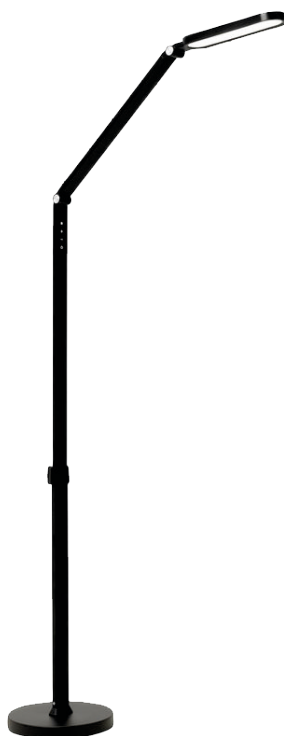

FERRARA LED 13W CCT  
Obj. kód 325006



obj. kód	typ	farba	rozmer (mm)
325006	FERRARA LED 13W CCT	čierna	641-1640 x 210 x 450



## MAGICAL

materiál: plast

LED

7 W

220-240 V

50/60 Hz

IP 20

25000h

RGB



MAGICAL LED 7W RGB  
Obj. kód 325211

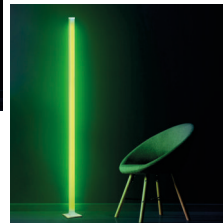
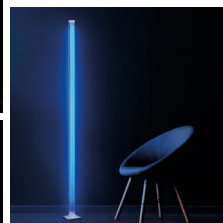
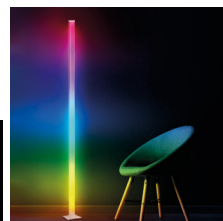
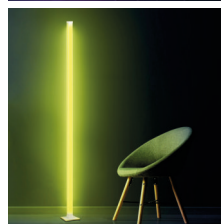
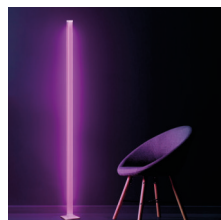

obj. kód	typ	farba	rozmer (mm)
325211	MAGICAL LED 7W RGB	biela	125x125x1500

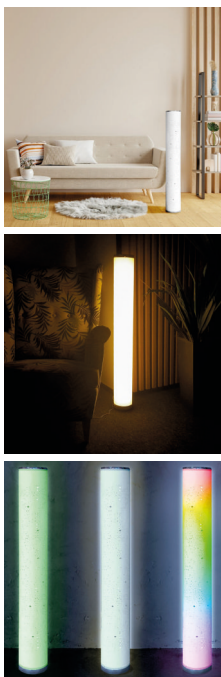

STELLA LED 12W RGB+W  
Obj. kód 325341

## STELLA

materiál: plast

LED

12 W

220-240 V

50/60 Hz

IP 20

25000h

3000 K  
+ RGB



obj. kód	typ	farba	rozmer (mm)
325341	STELLA LED 12W RGB+W	biela	D129x1030

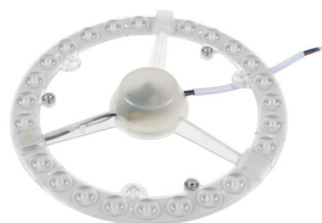

LED modul ARKO,  
vymeniteľný



ROVER KM1071-24W  
Obj. kód 62213244



ROVER KM1071-18W  
Obj. kód 62213184



ROVER KM1071-12W  
Obj. kód 62213124

## ROVER

materiál:  
kov, plast

LED

220-240 V

50/60 Hz

4000 K

RA>80

IP 44

30000 h



obj. kód	typ	farba	výkon	lm	rozmer (mm)
62213124	ROVER KM1071-12W	biela	12 W	1020	D260x100
62213184	ROVER KM1071-18W	biela	18 W	1550	D330x100
62213244	ROVER KM1071-24W	biela	24 W	2040	D380x100

LED stropnice s vymeniteľným modulom.





# Stropnice

## WOODY

materiál:  
kov, plast

LED

220-240 V

50/60 Hz

4000 K

25000 h



IP 20



Ra>80



WOODY-30 LED 15W 4000K  
Obj. kód 319005



WOODY-40 LED 24W 4000K  
Obj. kód 319012

obj. kód	typ	W	lm	farba	rozmer (mm)
319005	WOODY-30 LED 15W 4000K	15	1600	biela, hnedá	D280x40
319012	WOODY-40 LED 24W 4000K	24	2600	biela, hnedá	D380x48



## VENERA

materiál: plast

LED

170-240 V

50 Hz

4000 K

25000 h



IP 40



Ra>80



VENERA-18W D22 4000K  
Obj. kód 2027120



VENERA-24W D29 4000K  
Obj. kód 2027130



VENERA-36W D35 4000K  
Obj. kód 2027140



VENERA-50W D45 4000K  
Obj. kód 2027150

obj. kód	typ	W	lm	farba	rozmer (mm)
2027120	VENERA-18W D22 4000K	18	2160	biela	D220x40
2027130	VENERA-24W D29 4000K	24	2880	biela	D290x42
2027140	VENERA-36W D35 4000K	36	4320	biela	D350x43
2027150	VENERA-50W D45 4000K	50	6000	biela	D450x48





KM1061 15W  
Obj. kód 62216154

## AKRA

materiál: PC

LED

185-265 V

50 Hz

4000 K

RA>80

IP 54

30000 h



obj. kód	typ	farba	W	lm	rozmer (mm)
62216154	KM1061-15W	biela	15	1350	D220x50mm



HCP3004N 30W 4000K, obj. kód 62700304  
HCP3004C 30W 6000K, obj. kód 62700306



HCP3014N 30W 4000K, obj. kód 62700314  
HCP3014C 30W 6000K, obj. kód 62700316

## HCP

materiál: plast

LED

180-260 V

50 Hz

30 W

3200 lm

Ra>80

IP 20

25000 h



obj. kód	typ	farba svetla	farba	rozmer (mm)
62700304	HCP3004N 30W 4000K	neutrálina	biela	D330x53
62700306	HCP3004C 30W 6000K	studená	biela	D330x53
62700314	HCP3014N 30W 4000K	neutrálina	biela	330x330x53
62700316	HCP3014C 30W 6000K	studená	biela	330x330x53



# Stropnice

## PEARL-A

materiál:  
kov, plast

LED

180-265 V

50 Hz

CCT  
3000-6400 K

Ra>80



IP 20



20000 h



3000 K



6400 K



PEARL-A35, LED 50W, obj. kód 2024600



PEARL-A45, LED 75W, obj. kód 2024610

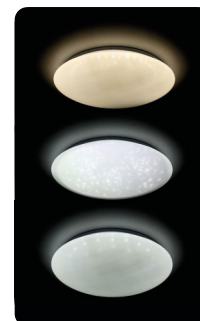

obj. kód	typ	farba	výkon	lm	rozmer (mm)
2024600	PEARL-A35, LED 50W	biela	50 W	3200	D385x110
2024610	PEARL-A45, LED 75W	biela	75 W	4200	D485x110

LED stropnica s diaľkovým ovládaním.



## SERA

materiál:  
kov, plast

LED

220-240 V

50/60 Hz

CCT  
3000-6500 K

RA>80



IP 20



25000 h



3000 K



6400 K



SERA KM2580-60W, obj. kód 62212580



SERA KM2550-48W, obj. kód 62212550

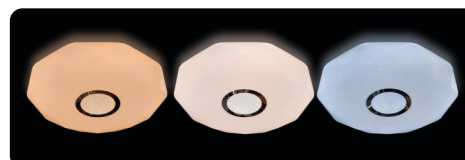

obj. kód	typ	farba	W	lm	rozmer (mm)
62212550	SERA KM2550-48W	biela	48	3600	D520x100
62212580	SERA KM2580-60W	biela	60	4500	D780x110





FINESSE R4-45 D48 LED 60W CCT-DIP WHT  
Obj. kód 2026290

## FINESSE R4

materiál:  
kov, plast

LED

60 W

180-265 V

50 Hz

CCT  
3000-6000 K



4800 lm



Ra>80



IP 20



30000 h



obj. kód	typ	farba	rozmer (mm)
2026290	FINESSE R4-45 D48 LED 60W CCT-DIP WHT	biela	D480x50



FINESSE R3-30 D40 LED 40W CCT-DIP NCK  
Obj. kód 2026050

## FINESSE R3

materiál:  
kov, plast

LED

180-265 V

50 Hz

CCT  
3000-6000 K

Ra>80



IP 20



30000 h



30000 h



obj. kód	typ	farba	výkon	lm	rozmer (mm)
2026050	FINESSE R3-30 D40 LED 30W CCT-DIP NCK	nikel	30 W	2400	D400x100

## FINESSE R2

materiál:  
kov, plast

LED

45 W

180-265 V

50 Hz

CCT  
3000-6000 K

3600 lm



Ra>80



IP 20



30000 h



FINESSE R2-45 D50 LED 45W CCT-DIP WHT+WO  
Obj. kód 2026220



FINESSE R2-45 D50 LED 45W CCT-DIP BLC+WO  
Obj. kód 2026230

obj. kód	typ	farba	rozmer (mm)
2026220	FINESSE R2-45 D50 LED 45W CCT-DIP WHT+WO	biela, drevo	D500x50
2026230	FINESSE R2-45 D50 LED 45W CCT-DIP BLC+WO	čierna, drevo	D500x50



## FINESSE R1

materiál:  
kov, plast

LED

180-265 V

50 Hz

3000-6000 K

Ra>80

IP 20



30000 h



120°



FINESSE R1-25 D30 LED 25W CCT-DIP WHT  
Obj. kód 2026060



FINESSE R1-35 D30 LED 25W CCT-DIP WHT  
Obj. kód 2026070

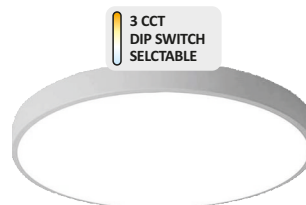

FINESSE R1-45 D40 LED 45W CCT-DIP WHT  
Obj. kód 2026080



FINESSE R1-65 D60 LED 60W DIM+MOB WHT  
Obj. kód 2026090

obj. kód	typ	farba	W	lm	rozmer (mm)
2026060	FINESSE R1-25 D30 LED 25W CCT-DIP WHT	biela	25	2000	D300x50
2026070	FINESSE R1-35 D40 LED 35W CCT-DIP WHT	biela	35	2800	D400x50
2026080	FINESSE R1-45 D50 LED 45W CCT-DIP WHT	biela	45	3600	D500x50
2026090	FINESSE R1-60 D60 LED 60W DIM+MOB WHT	biela	60	4800	D600x50



# Stropnice



3 CCT  
DIP SWITCH  
SELCTABLE



FINESSE R1-25 D30 LED 25W CCT-DIP BLC  
Obj. kód 2026100

3 CCT  
DIP SWITCH  
SELCTABLE



FINESSE R1-35 D30 LED 25W CCT-DIP BLC  
Obj. kód 2026110

3 CCT  
DIP SWITCH  
SELCTABLE



FINESSE R1-45 D40 LED 45W CCT-DIP BLC  
Obj. kód 2026120

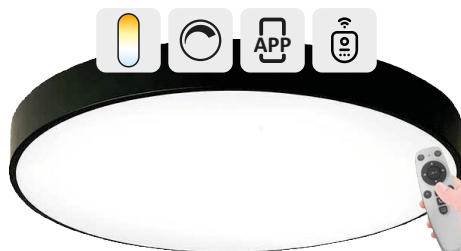

FINESSE R1-65 D60 LED 60W DIM+MOB BLC  
Obj. kód 2026130



HSR 3X1.5M ROUND HAN SET BLC  
Obj. kód 2026410

## FINESSE R1

materiál:  
kov, plast

LED

180-265 V

50 Hz

3000-6000 K

Ra>80

IP 20

30000 h

obj. kód	typ	farba	W	lm	rozmer (mm)
2026100	FINESSE R1-25 D30 LED 25W CCT-DIP BLC	čierna	25	2000	D300x50
2026110	FINESSE R1-35 D40 LED 35W CCT-DIP BLC	čierna	35	2800	D400x50
2026120	FINESSE R1-45 D50 LED 45W CCT-DIP BLC	čierna	45	3600	D500x50
2026130	FINESSE R1-60 D60 LED 60W DIM+MOB BLC	čierna	60	4800	D600x50



Voliteľné príslušenstvo

obj. kód	typ	farba	príslušenstvo	dĺžka lanka (mm)
2026410	HSR 3X1.5M ROUND HAN SET BLC	čierna	záves	3x1500



3 CCT  
DIP SWITCH  
SELCTABLE



FINESSE S1-25 30X30 LED 25W CCT-DIP WHT  
Obj. kód 2026140

3 CCT  
DIP SWITCH  
SELCTABLE

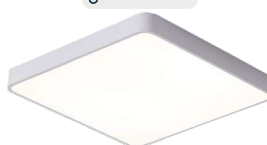

FINESSE S1-35 40X40 LED 35W CCT-DIP WHT  
Obj. kód 2026150

3 CCT  
DIP SWITCH  
SELCTABLE



FINESSE S1-45 50X50 LED 45W CCT-DIP WHT  
Obj. kód 2026160



FINESSE S1-60 60X60 LED 60W DIM+MOB WHT  
Obj. kód 2026170

## FINESSE S1

materiál:  
kov, plast

LED

180-265 V

50 Hz

3000-6000 K

Ra>80

IP 20

30000 h

obj. kód	typ	farba	W	lm	rozmer (mm)
2026140	FINESSE S1-25 30X30 LED 25W CCT-DIP WHT	biela	25	2000	300x300x50
2026150	FINESSE S1-35 40X40 LED 35W CCT-DIP WHT	biela	35	2800	400x400x50
2026160	FINESSE S1-45 50X50 LED 45W CCT-DIP WHT	biela	45	3600	500x500x50
2026170	FINESSE S1-60 60X60 LED 60W DIM+MOB WHT	biela	60	4800	600x600x50





# Stropnice

3 CCT  
DIP SWITCH  
SELCTABLE



FINESSE S1-25 30X30 25W CCT-DIP BLC  
Obj. kód 2026180

3 CCT  
DIP SWITCH  
SELCTABLE

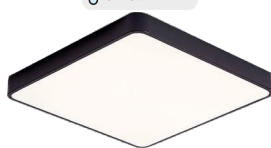

FINESSE S1-35 40X40 35W CCT-DIP BLC  
Obj. kód 2026190

3 CCT  
DIP SWITCH  
SELCTABLE



FINESSE S1-45 50X50 45W CCT-DIP BLC  
Obj. kód 2026200

## FINESSE S1

materiál:  
kov, plast

LED

180-265 V

50 Hz

3000-6000 K

Ra>80

IP 20



30000 h



FINESSE S1-60 60X60 LED 60W DIM+MOB BLC  
Obj. kód 2026210

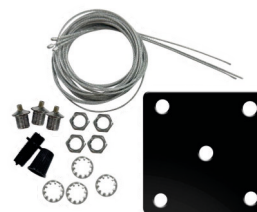

HSS 4X1.5M SQUARE HAN SET BLC  
Obj. kód 2026420

obj. kód	typ	farba	W	lm	rozmer (mm)
2026180	FINESSE S1-25 30X30 LED 25W CCT-DIP BLC	čierna	25	2000	300x300x50
2026190	FINESSE S1-35 40X40 LED 35W CCT-DIP BLC	čierna	35	2800	400x400x50
2026200	FINESSE S1-45 50X50 LED 45W CCT-DIP BLC	čierna	45	3600	500x500x50
2026210	FINESSE S1-60 60X60 LED 60W DIM+MOB BLC	čierna	60	4800	600x600x50

Voliteľné príslušenstvo

obj. kód	typ	farba	príslušenstvo	dĺžka lanka (mm)
2026420	HSS 4X1.5M SQUARE HAN SET BLC	čierna	záves	4x1500



## DISC

materiál:  
kov, plast

LED

180-265 V

50 Hz

CCT  
3000-6000 K

Ra>80

IP 20



30000 h



DISC-1 D50 LED 46W CCT-DIP WHT+BLC  
Obj. kód 2026240

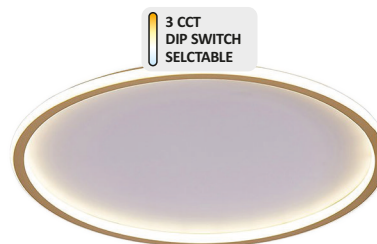

DISC-2 D50 LED 46W CCT-DIP WHT+GLD  
Obj. kód 2026250

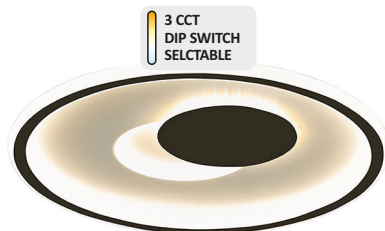

DISC-3 D40 LED 52W CCT-DIP WHT+BLC  
Obj. kód 2026260

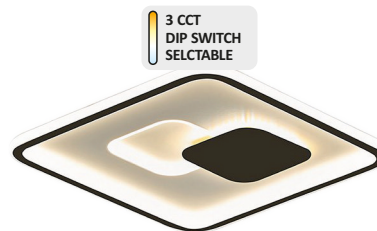

DISC-4 40X40 LED 60W CCT-DIP WHT+BLC  
Obj. kód 2026270

obj. kód	typ	farba	W	lm	rozmer (mm)
2026240	DISC-1 D50 LED 46W CCT-DIP WHT+BLC	biela, čierna	46	2760	D500x45
2026250	DISC-2 D50 LED 46W CCT-DIP WHT+GLD	biela, zlatá	46	2760	D500x45
2026260	DISC-3 D40 LED 52W CCT-DIP WHT+BLC	biela, čierna	52	3120	D400x45
2026270	DISC-4 40X40 LED 60W CCT-DIP WHT+BLC	biela, čierna	60	3600	400x400x70



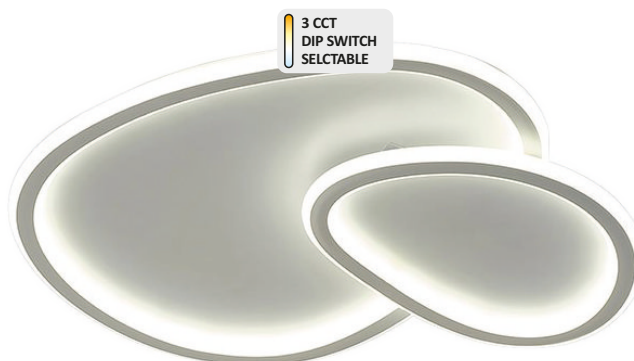

RING 48x40 LED 64W CCT-DIP WHT  
Obj. kód 2026280

## RING

materiál:  
kov, plast

LED

180-265 V

50 Hz

CCT  
3000-6000 K

Ra>80



IP 20



30000 h



obj. kód	typ	farba	W	lm	rozmer (mm)
2026280	RING 48x40 LED 64W CCT-DIP WHT	biela	64	3840	D480x50

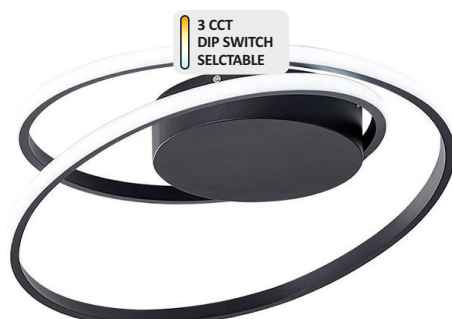

RING 38 D46 LED 38W CCT-DIP BLC  
Obj. kód 2026370



RING 38 D46 LED 38W CCT-DIP WHT  
Obj. kód 2026380

## RING 38

materiál:  
kov, plast

LED

38 W

180-265 V

50 Hz

CCT  
3000-6000 K

2280 lm



Ra>80



IP 20



30000 h



obj. kód	typ	farba	rozmer (mm)
2026370	RING 38 D46 LED 38W CCT-DIP BLC	čierna	D460x120
2026380	RING 38 D46 LED 38W CCT-DIP WHT	biela	D460X120

## FINESSE D

materiál:  
kov, plast

LED

180-260 V

50 Hz

CCT  
3000-6000 K

RA>80

IP 20



30000 h



FINESSE D-45 D50 LED  
45W CCT-DIP BLC, obj. kód 2026300



FINESSE D-60 D60 LED  
60W DIM+MOB BLC, obj. kód 2026310

obj. kód	typ	farba	W	lm	rozmer (mm)
2026300	FINESSE D-45 D50 LED 45W CCT-DIP BLC	čierna	45	3600	D500x70
2026310	FINESSE D-60 D60 LED 60W DIM+MOB BLC	čierna	60	4800	D600x70



## FINESSE F

materiál:  
kov, plast

LED

180-260 V

50 Hz

CCT  
3000-6000 K

RA>80

IP 20



30000 h



FINESSE F-45 50X50 LED 45W CCT-DIP BLC  
Obj. kód 2026320



FINESSE F-60 60X60 LED 60W DIM+MOB BLC  
Obj. kód 2026330

obj. kód	typ	farba	W	lm	rozmer (mm)
2026320	FINESSE F-45 50X50 LED 45W CCT-DIP BLC	čierna	45	3600	500x500x70
2026330	FINESSE F-60 60X60 LED 60W DIM+MOB BLC	čierna	60	4800	600x600x70





WAVE D60 LED 48W CCT-DIP BLC  
Obj. kód 2026390



WAVE D60 LED 48W CCT-DIP WHT  
Obj. kód 2026400

## WAVE

materiál:  
kov, plast

LED

48 W

180-265 V

50 Hz

CCT  
3000-6000 K

2280 lm



Ra>80



IP 20



30000 h



obj. kód	typ	farba	rozmer (mm)
2026390	WAVE D60 LED 48W CCT-DIP BLC	čierna	D600x180x1500
2026400	WAVE D60 LED 48W CCT-DIP WHT	biela	D600x180x1500



DUO D40+60 LED 48W CCT-DIP BLC  
Obj. kód 2026340

## DUO

materiál:  
kov, plast

LED

48 W

180-265 V

50 Hz

CCT  
3000-6000 K

2280 lm



Ra>80



IP 20



30000 h



obj. kód	typ	farba	rozmer (mm)
2026340	DUO D40+60 LED 48W CCT-DIP BLC	čierna	D600-D400x1500



# Stropnice

## TRIO

materiál:  
kov, plast

LED

40 W

175-265 V

50 Hz

4000 K

3200 lm

Ra>80



IP 20



50000 h

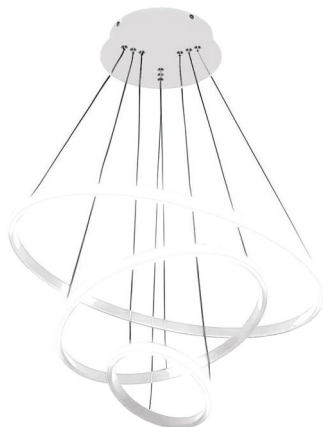

TRIO 40W 4000K WH  
Obj. kód 2025960



TRIO 40W 4000K BL  
Obj. kód 2025961

obj. kód	typ	farba	rozmer (mm)
2025960	TRIO 40W 4000K WH	biela	D600-D400-D200x1600
2025961	TRIO 40W 4000K BL	čierna	D600-D400-D200x1600



## TRIO-1

materiál:  
kov, plast

LED

56 W

180-265 V

50 Hz

CCT  
3000-6000 K

3360 lm

Ra>80



IP 20



30000 h



TRIO-1 D20+40+60 LED 56W CCT-DIP BLC  
Obj. kód 2026350



TRIO-1 D20+40+60 LED 56W CCT-DIP WHT  
Obj. kód 2026360

obj. kód	typ	farba	rozmer (mm)
2026350	TRIO-1 D20+40+60 LED 56W CCT-DIP BLC	čierna	D600-D400-D200x1500
2026360	TRIO-1 D20+40+60 LED 56W CCT-DIP WHT	biela	D600-D400-D200x1500



# Stropnice

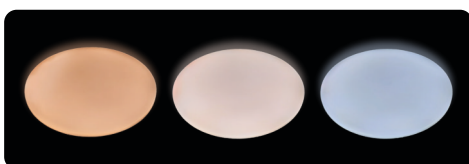

KONA KM2240-36W, obj. kód: 62212240



KONA KM2250-48W, obj. kód: 62212250

## KONA

materiál:  
kov, plast

LED

220-240 V

50/60 Hz

CCT  
3000-6500 K



RA>80



IP 20



25000 h



obj. kód	typ	farba	W	lm	rozmer (mm)
62212240	KONA KM2240-36W	biela	36	2700	D390x60
62212250	KONA KM2250-48W	biela	48	3600	D490x60



DESERT 40 - 48W  
Obj. kód 310798



DESERT 40K - 72W  
Obj. kód 312723

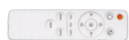

DESERT 50 - 72W  
Obj. kód 324313

## DESERT

materiál:  
kov, plast

LED

220-240 V

50/60 Hz

CCT  
3000-6500 K

Ra>80



IP 20



25000 h



obj. kód	typ	farba	W	lm	rozmer (mm)
310798	DESERT 40 - 48W	biela, chróm	48	5200	D380x60
324313	DESERT 50 - 72W	biela, chróm	72	8000	D480x60
312723	DESERT 40K - 72W	biela, chróm	72	8000	430x430x65





# Stropnice

## SYRIUS

materiál:  
kov, plast

LED

220-240 V

50/60 Hz

CCT  
3000-6500 K

Ra>80



IP 20



25000 h



SYRIUS 40K - 72W  
Obj. kód 312730



obj. kód	typ	farba	W	lm	rozmer (mm)
312730	SYRIUS 40K - 72W	biela, chróm	72	8000	430x430x70



## GLOSSY

materiál:  
kov, plast

LED

220-240 V

50/60 Hz

CCT  
3000-6500 K

Ra>80

IP 20



25000 h



GLOSSY 1 - 72W  
Obj. kód 314819



obj. kód	typ	farba	W	lm	rozmer (mm)
314819	GLOSSY 1 - 72 W	biela, chróm	72	8000	D510x70



# Stropnice



RATAN KM2340-24W  
Obj, kód 62212340



RATAN KM2350-48W  
Obj, kód 62212350

## RATAN

materiál:  
kov, plast

LED

100-240 V

50/60 Hz

CCT  
3000-6500 K

Ra>80



IP 20



30000 h



obj. kód	typ	farba	W	lm	rozmer (mm)
62212340	RATAN KM2340-24W	biela	24	1800	D380x65
62212350	RATAN KM2350-48W	biela	48	3600	D480x65



FLORA KM2440-24W  
Obj, kód 62212440



FLORA KM2450-48W  
Obj, kód 62212450

## FLORA

materiál:  
kov, plast

LED

100-240 V

50/60 Hz

CCT  
3000-6500 K

Ra>80



IP 20



30000 h



obj. kód	typ	farba	W	lm	rozmer (mm)
62212440	FLORA KM2440-24W	biela, čierna	24	1800	D390x60
62212450	FLORA KM2450-48W	biela, čierna	48	3600	D490x60



# Stropnice

## DIAMOND

materiál:  
kov, plast

LED

180-265 V

50/60 Hz

CCT  
3000-6400 K

Ra>80

IP 20



20000 h



F

3000 K

IR

6400 K



DIAMOND-DG35 48W  
Obj, kód 2025450



DIAMOND-DG45 72W  
Obj, kód 2025460

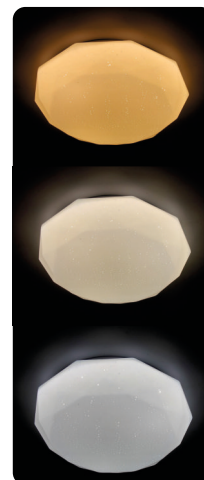

obj. kód	typ	farba	W	lm	rozmer (mm)
2025450	DIAMOND-DG35 LED 48W	biela	48	1680-3600-1920	D410x85
2025460	DIAMOND-DG45 LED 72W	biela	72	2700-5760-3060	D510x105



## PEARL-M

materiál:  
kov, plast

LED

180-265 V

50/60 Hz

CCT  
3000-6400 K

Ra>80

IP 20



20000 h



F

3000 K

IR

6400 K



PEARL-M35 LED 48W  
Obj, kód 2025470

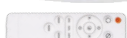

PEARL-M45 LED 72W  
Obj, kód 2025480



obj. kód	typ	farba	W	lm	rozmer (mm)
2025470	PEARL-M35 LED 48W	biela	48	1680-3600-1920	D380x80
2025480	PEARL-M45 LED 72W	biela	72	2700-5760-3060	D480x90





TORNO KM1081-12W  
Obj. kód 62218124



TORNO KM1081-18W  
Obj. kód 62218184



## TORNO

materiál:  
kov, plast

LED

220-240 V

50/60 Hz

4000 K

Ra>80

IP 44

30000 h

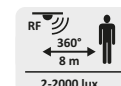

obj. kód	typ	farba	W	lm	rozmer (mm)
62218124	TORNO KM1081-12W	biela	12	900	D260x90
62218184	TORNO KM1081-18W	biela	18	1400	D330x105



DIANA-18W 4000K  
Obj. kód 2025840



DIANA-18W 6000K  
Obj. kód 2025850



## DIANA

materiál:  
plast

LED

220-240 V

50 Hz

Ra>80

IP 20

25000 h

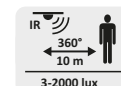

obj. kód	typ	farba	W	lm	farba svetla	rozmer (mm)
2025840	DIANA-18W 4000K	biela	18	1575	neutrálina	D295x70
2025850	DIANA-18W 6000K	biela	18	1620	studená	D295x70



# Stropnice

## MONO

materiál:  
kov, plast

LED

100-240 V

50/60 Hz

CCT  
3000-6500 K

Ra>80

IP 20



30000 h



F



obj. kód	typ	farba	W	lm	rozmer (mm)
62212640	MONO KM2640-24W	biela, čierna	24	2500	D380x75
62212650	MONO KM2650-48W	biela, čierna	48	5000	D480x75

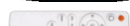

MONO KM2640-24W  
Obj. kód 62212640

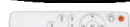

MONO KM2650-48W  
Obj. kód 62212650

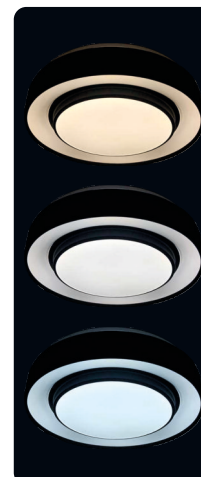

## LEMA

materiál:  
kov, plast

LED

185-265 V

50 Hz

4000 K

Ra>80

IP 20

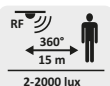

30000 h



F



obj. kód	typ	farba	výkon	lm	rozmer (mm)
62215244	KM1051-24W S 4000K	biela	24 W	1500	D350x95



KM1051-24W S 4000K  
Obj. kód 62215244



NOTILUS-RH35 48W  
Obj. kód 2025430



NOTILUS-RH45 72W  
Obj. kód 2025440

## NOTILUS

materiál:  
kov, plast

LED

180-265 V

50/60 Hz

CCT  
3000-6400 K

Ra>80



IP 20



20000 h



obj. kód	typ	farba	W	lm	rozmer (mm)
2025430	NOTILUS-RH35 48W CCT	biela, tnsparent	48	1680-3600-1920	D400x80
2025440	NOTILUS-RH45 72W CCT	biela, tnsparent	72	2700-5760-3060	D510x105



LUZ BR 12W 4000K  
Obj. kód 3401000



LUZ BR 18W 4000K  
Obj. kód 3400700



LUZ BRN 25W WH 4000K  
Obj. kód 3400920



LUZ BRN 25W BL 4000K  
Obj. kód 3401010

## LUZ-BR LUZ-BRN

materiál:  
plast

LED

220-240 V

50/60 Hz

4000 K

Ra>80



IP 65



25000 h



obj. kód	typ	farba	W	lm	rozmer (mm)
3401000	LUZ BR 12W 4000K	biela	12	816	D170x50
3400700	LUZ BR 18W 4000K	biela	18	1224	D220x99
3400920	LUZ BRN 25W WH 4000K	biela	25	1700	D270x93
3401010	LUZ BRN 25W BL 4000K	čierna	25	1525	D270x93



# Stropnice

## ADAR

materiál:  
kov, plast

LED

220-240 V

50/60 Hz

4000 K

Ra>80

IP 44

25000 h

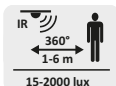

ADAR 17W PIR  
Obj. kód 313416

obj. kód	typ	farba	W	lm	rozmer (mm)
313416	ADAR 17W PIR	biela	17	1900	D330x85



## LIKYA P

materiál:  
plast

E27

max.  
2x 25W

220-240 V

50/60 Hz

IP 20

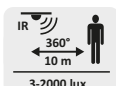

LIKYA P 2XE27  
Obj. kód 2022661

obj. kód	typ	farba	rozmer (mm)
2022661	LIKYA P 2XE27	biela	D290x100

# Stropnice



ORI-CH 12W 4000K IP65  
Obj. kód 2025970



ORI-CH 18W 4000K IP65  
Obj. kód 2025980

## ORI-CH

materiál:  
plast

LED

220-240 V

50/60 Hz

4000 K

Ra>80

IP 65

25000 h



obj. kód	typ	farba	W	lm	rozmer (mm)
2025970	ORI-CH 12W 4000K IP65	antracit	12	840	D160x74
2025980	ORI-CH 18W 4000K IP65	antracit	18	1260	D220x69

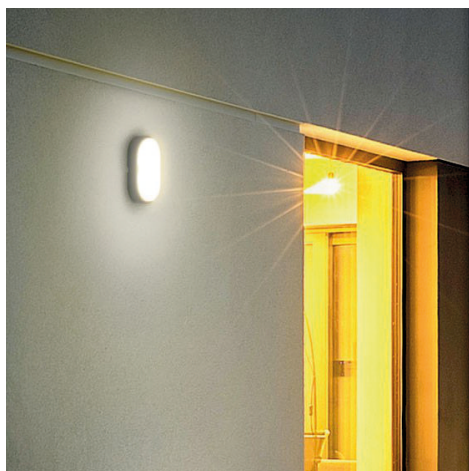

LUZ BO 12W 4000K  
Obj. kód 3400850

## LUZ-BO

materiál:  
plast

LED

220-240 V

50/60 Hz

4000 K

Ra>80

IP 65

25000 h



obj. kód	typ	farba	W	lm	rozmer (mm)
3400850	LUZ BO 12W 4000K	biela	12	816	205x105x54



# Stropnice

## ORI-W

materiál:  
plast

LED

220-240 V

50/60 Hz

4000 K

RA>80

IP 65



120°

25000 h



ORI-W1 12W 4000K IP65  
Obj. kód 2025600



ORI-W2 18W 4000K IP65  
Obj. kód 2025620

obj. kód	typ	farba	W	lm	rozmer (mm)
2025600	ORI-W1 12W 4000K IP65	čierna	12	1020	D170x68
2025620	ORI-W2 18W 4000K IP65	čierna	18	1260	D220x68



## ORI-BB

## ORI-C6

materiál:  
plast

LED

220-240 V

50/60 Hz

4000 K

Ra>80

IP 65



120°

25000 h

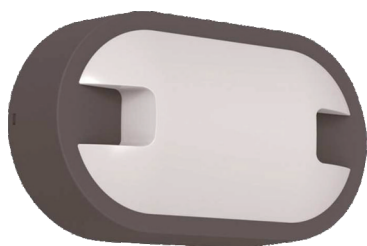

ORI-BB 15W 4000K IP65  
Obj. kód 2025650

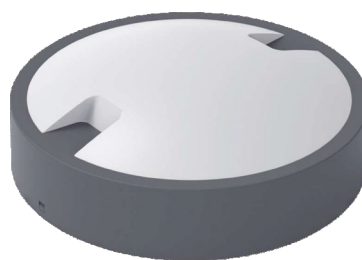

ORI-C6 18W 4000K IP65  
Obj. kód 2025640

obj. kód	typ	farba	W	lm	rozmer (mm)
2025650	ORI-BB 15W 4000K IP65	antracit, biela	15	975	215x125x59
2025640	ORI-C6 18W 4000K IP65	antracit, biela	18	1260	D220x65





LUZ BCO 12W 4000K  
Obj. kód 3401030

## LUZ-BCO

materiál:  
kov, plast

LED

220-240 V

50/60 Hz

4000 K

Ra>80



120°

IP 65



25000 h



F



obj. kód	typ	farba	W	lm	rozmer (mm)
3401030	LUZ BCO 12W 4000K	biela	12	840	190x113x40



LUZ BRG 12W 4000K  
Obj. kód 3400870

## LUZ-BRG

materiál: plast

LED

220-240 V

50/60 Hz

4000 K

Ra>80



120°

IP 65



25000 h



F



obj. kód	typ	farba	W	lm	rozmer (mm)
3400870	LUZ BRG 12W 4000K	čierna	12	816	D170x64



# Stropnice

## LUZ-BC

materiál:  
plast, kov

LED

220-240 V

50/60 Hz

4000 K

Ra>80

IP 65



120°

25000 h



LUZ BC 15W 4000K  
Obj. kód 3400890



LUZ BC 15W 4000K BLACK  
Obj. kód 3401060



LUZ BC 30W 4000K  
Obj. kód 3401040

obj. kód	typ	W	lm	farba	rozmer (mm)
3400890	LUZ BC 15W 4000K	15	1020	biela	D190x45
3401060	LUZ BC 15W 4000K BLACK	15	825	čierna	D190x42
3401040	LUZ BC 30W 4000K WH	30	2040	biela	D320x50



## LUZ-BS

materiál:  
plast, kov

LED

220-240 V

50/60 Hz

4000 K

Ra>80

IP 65



120°

25000 h



LUZ BS 15W 4000K  
Obj. kód 3400860



LUZ BS 30W 4000K WH  
Obj. kód 3401050



LUZ BS 15W BL 4000K  
Obj. kód 3401020

obj. kód	typ	farba	W	lm	rozmer (mm)
3400860	LUZ BS 15W 4000K	biela	15	1020	190x190x45
3401020	LUZ BS 15W BL 4000K	čierna	15	720	190x190x45
3401050	LUZ-BS 30W 4000K WH	biela	30	2040	320x320x50





ROUND BL 304064  
Obj. kód 60304064



ROUND CN 604065  
Obj. kód 60604065

obj. kód	typ	farba
60304064	ROUND BL 304064	biela
60604065	ROUND CN 604065	čierna

## ROUND

materiál: plast, sklo  
rozmer: D210x105 mm

E27

max. 100 W

230 V

50 Hz

IP 44



BRICK  
Obj. kód 60350009

## BRICK

materiál: plast  
rozmer:  
250x120x120 mm

E27

21 W

230 V

50 Hz

IP 54



obj. kód	typ	farba
60350009	350009 BRICK	šedá



# Stropnice



## LUZ-BRP

materiál: plast

LED

220-240 V

50/60 Hz

4000 K

Ra>80

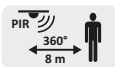

IP 65



25000 h



LUZ BRP 18W 4000K  
Obj. kód 3400880

obj. kód	typ	farba	W	lm	senzor	rozmer (mm)
3400880	LUZ BRP 18W 4000K	biela	18	1224	áno - pohybový, súmrakový	D200x55



OVAL 60 BL 302015  
Obj. kód 60302015



OVAL 60 HN 502019  
Obj. kód 60502019



OVAL 60 CN 602016  
Obj. kód 60602016

## OVAL

materiál:

plast, sklo

rozmer:

170x125x110 mm

E27

230 V

50 Hz

IP 44



OVAL 60 SIM2 121173  
Obj. kód 60121173



OVAL 100 SD/PR 100178  
Obj. kód 60100178

obj. kód	typ	farba	W
60302015	OVAL 60 BL 302015	biela	60
60602016	OVAL 60 CN 602016	čierna	60
60502019	OVAL 60 HN 502019	hnedá	60
60100178	OVAL 100 SD/PR 100178	šedá	100
60121173	OVAL 60 SIM2 121173	šedá	60

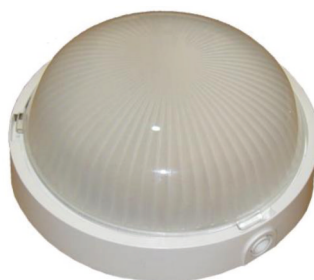

VEGA BL-OP 015021  
Obj. kód 60015021



VEGA BL-PR 015014  
Obj. kód 60015014

## VEGA

materiál:  
plast, sklo  
rozmer:  
D239x95 mm

E27

100 W

230 V

50 Hz

IP 44



obj. kód	typ	farba	tienidlo
60015021	VEGA BL-OP 015021	biela	opal
60015014	VEGA BL-PR 015014	biela	prismatik



ALFA-7070T 100W BL-PR  
Obj. kód 60013011



ALFA-7070T 75W BL-PR  
Obj. kód 60013012

## ALFA

materiál:  
ALFA 100W: plast, sklo  
ALFA 75W: plast  
rozmer:  
D245x85 mm

E27

75-100 W

230 V

50 Hz

IP 44



ALFA-7070T 75W BL-MA PIR  
Obj. kód 60013015



10-2000 lux  
5s. - 8min.



ALFA-7070T 75W BL-MA HF  
Obj. kód 60013017



30-2000 lux  
5s. - 10min.

obj. kód	typ	farba	W	senzor
60013011	ALFA-7070T 100W BL-PR	biela	100	nie
60013012	ALFA-7070T 75W BL-PR	biela	75	nie
60013015	ALFA-7070T 75W BL-MA PIR	biela	75	áno, IR
60013017	ALFA-7070T 75W BL-MA HF	biela	75	áno, RF

## POINT

materiál: plast, sklo  
rozmer:  
D230x90 mm

E27

max.  
100 W

230 V

50 Hz

IP 44



225055 POINT  
Obj. kód 60225055

obj. kód	typ	farba
60225055	225055 POINT	biela

## LUNA

materiál:  
plast, sklo  
rozmer:  
D240x85 mm

E27

100 W

230 V

50 Hz

IP 44



LUNA BL-OP 013027  
Obj. kód 60013027



LUNA CN-OP 891809  
Obj. kód 60891809



LUNA BL-PR 013010  
Obj. kód 60013010



LUNA CN-PR 886669  
Obj. kód 60886669

obj. kód	typ	farba	tienidlo
60013027	LUNA BL-OP 013027	biela	opal
60013010	LUNA BL-PR 013010	biela	prismatik
60891809	LUNA CN-OP 891809	čierna	opal
60886669	LUNA CN-PR 886669	čierna	prismatik



TRIO-8080T 75W BL-TR  
Obj. kód 60013020

obj. kód	typ	farba
60013020	TRIO-8080T 75W BL-TR	biela

## TRIO

materiál: plast  
rozmer: D245x85 mm

E27

230 V

max. 75 W

50 Hz

IP 44



OVAL-7040T-P 40W BL  
Obj. kód 60302016



OVAL-7063T 100W BL  
Obj. kód 60302017



OVAL-7063T 75W BL  
Obj. kód 60302018

## OVAL

materiál:  
OVAL 40W: plast  
OVAL 100W: plast, sklo, kov  
OVAL 75W: plast, kov

E27

230 V

50 Hz



IP 44



obj. kód	typ	farba	W	rozmer (mm)
60302016	OVAL-7040T-P 40W BL	biela	40	170x125x115
60302017	OVAL-7063T 100W BL	biela	100	195x135x115
60302018	OVAL-7063T 75W BL	biela	75	195x135x115



# Podhľadové

## KM144 KM429

materiál: kov

GX 5,3

50 W

12 V

IP 20



KM144-CH  
Obj. kód 63000502

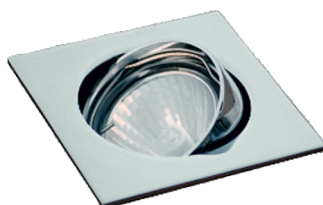

KM429-CH  
Obj. kód 63000512

obj. kód	typ	farba	rozmer (mm)	otvor (mm)
63000502	KM144-CH	chróm	75x75	D60
63000512	KM429-CH	chróm	80x80	D75



OH14 MAT BL  
Obj. kód 63000520



OH14 MAT CN  
Obj. kód 63000521



OH14 CH  
Obj. kód 63000522

## OH14

materiál: kov

GX 5,3

50 W

12 V

50 Hz

IP 20



OH14 MAT CH  
Obj. kód 63000523



OH14 MAT PT  
Obj. kód 63000524

obj. kód	typ	farba	rozmer (mm)	otvor (mm)
63000520	OH14 MAT BL	matná biela	D82 x 34	D75
63000521	OH14 MAT CN	matná čierna	D82 x 34	D75
63000522	OH14 CH	chróm	D82 x 34	D75
63000523	OH14 MAT CH	matný chróm	D82 x 34	D75
63000524	OH14 MAT PT	patina	D82 x 34	D75

# Podhľadové



OH15 MAT BL  
Obj. kód 63000530



OH15 MAT CN  
Obj. kód 63000531



OH15 CN  
Obj. kód 63000532



OH15 MAT CN  
Obj. kód 63000533



OH15 MAT PT  
Obj. kód 63000534

obj. kód	typ	farba	rozmer (mm)	otvor (mm)
63000530	OH15 MAT BL	matná biela	D96 x 26	D80
63000531	OH15 MAT CN	matná čierna	D96 x 26	D80
63000532	OH15 CH	chróm	D96 x 26	D80
63000533	OH15 MAT CH	matný chróm	D96 x 26	D80
63000534	OH15 MAT PT	patina	D96 x 26	D80

## OH15

materiál: kov

GX 5,3

50 W

12 V

50 Hz

IP 20



OH28 CH  
Obj. kód 63000542

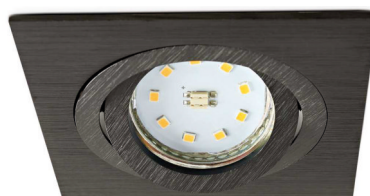

OH28 MAT CN  
Obj. kód 63000541

## OH28

materiál:  
kov

GX 5,3

50 W

12 V

IP 20



obj. kód	typ	farba	rozmer (mm)
63000542	OH28 CH	chróm	92x92
63000541	OH28 MAT CN	matná čierna	92x92



## Podhľadové

### ZANZI-P

materiál: plast

LED

1 W

100-240 V

50/60 Hz

Ra>80

IP 20

25000 h



ZANZI-P 1W 3000K WHITE  
Obj. kód 2026810



ZANZI-P 1W 4000K WHITE  
Obj. kód 2026820



ZANZI-P 1W 3000K BLACK  
Obj. kód 2026830



ZANZI-P 1W 4000K BLACK  
Obj. kód 2026840

obj. kód	typ	farba	lm	farba svetla	rozmer (mm)
2026810	ZANZI-P 1W 3000K WHITE	biela	75	teplá	D35x29
2026820	ZANZI-P 1W 4000K WHITE	biela	75	neutrálna	D35x29
2026830	ZANZI-P 1W 3000K BLACK	čierna	75	teplá	D35x29
2026840	ZANZI-P 1W 4000K BLACK	čierna	75	neutrála	D35x29



### ZANZI-M

materiál: hliník, plast

LED

3 W

100-240 V

50/60 Hz

Ra>80

IP 20

25000 h



ZANZI-M 3W 3000K M CHROM  
Obj. kód 2026850



ZANZI-M 3W 4000K M CHROM  
Obj. kód 2026860



ZANZI-M 3W 3000K WHITE  
Obj. kód 2026870



ZANZI-M 3W 4000K WHITE  
Obj. kód 2026880

obj. kód	typ	farba	lm	farba svetla	rozmer (mm)
2026850	ZANZI-M 3W 3000K M CHROM	matný chróm	225	teplá	D35x25
2026860	ZANZI-M 3W 4000K M CHROM	matný chróm	225	neutrálna	D35x25
2026870	ZANZI-M 3W 3000K WHITE	biela	225	teplá	D35x25
2026880	ZANZI-M 3W 4000K WHITE	biela	225	neutrálna	D35x25



# Podhľadové



NICK-R 5W 4200K  
Obj. kód 2026770



NICK-R 5W 6400K  
Obj. kód 2026780

## NICK-R

materiál: plast

LED

5W

100-240 V

50/60 Hz

Ra>80

IP 20



25000 h



obj. kód	typ	farba	lm	farba svetla	rozmer (mm)
2026770	NICK-R 5W 4200K	biela	590	neutrálna	D86x20
2026780	NICK-R 5W 6400K	biela	600	studená	D86x20



NICK-S 5W 4200K  
Obj. kód 2026790



NICK-S 5W 6400K  
Obj. kód 2026800

## NICK-S

materiál: plast

LED

5W

100-240 V

50/60 Hz

Ra>80

IP 20



25000 h



obj. kód	typ	farba	lm	farba svetla	rozmer (mm)
2026790	NICK-S 5W 4200K	biela	590	neutrálna	86x86x20
2026800	NICK-S 5W 6400K	biela	600	studená	86x86x20



# Podhl'adové

## FORMATO

materiál: kov, sklo

LED

220-240 V

50/60 Hz

4200K

Ra>80

IP 20

30000 h



FORMATO-D1 3W 4200K  
Obj. kód 2012460



FORMATO-D3 5W 4200K  
Obj. kód 2012520

obj. kód	typ	farba	W	lm	rozmer (mm)
2012460	FORMATO-D1 3W 4200K	chróm, biela	3	240	D100x70
2012520	FORMATO-D3 5W 4200K	chróm, biela	5	400	D140x70



## RITA-2

materiál: hliník, plast

LED

1 W

220-240 V

50/60 Hz

Ra>80

IP 20

30000 h



RITA-2 1W 3000K CHROM  
Obj. kód 2021580



RITA-2 1W 6000K CHROM  
Obj. kód 2021590

obj. kód	typ	farba	lm	farba svetla	rozmer (mm)
2021580	RITA-2 1W 3000K CHROM	chróm	100	teplá	D31x22
2021590	RITA-2 1W 6000K CHROM	chróm	100	studená	D31x22





ARIEL-R TRANSP  
Obj. kód 63000600



ARIEL-R BLACK  
Obj. kód 63000601

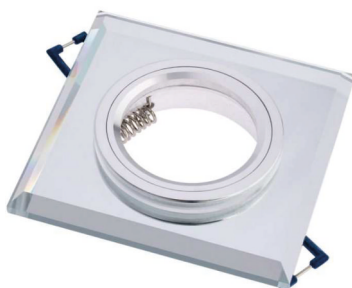

ARIEL-S TRANSP  
Obj. kód 63000602



ARIEL-S BLACK  
Obj. kód 63000603

obj. kód	typ	farba	rozmer (mm)	otvor (mm)
63000600	ARIEL-R TRANSP	transparentná	D90x20	D65
63000601	ARIEL-R BLACK	čierna	D90x20	D65
63000602	ARIEL-S TRANSP	transparentná	90x90x20	D65
63000603	ARIEL-S BLACK	čierna	90x90x20	D65

## ARIEL

materiál:  
kov, sklo

MR16

50 W

12 V

IP 20

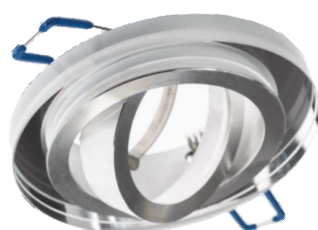

ARIAN-R TRANSP  
Obj. kód 63000610



ARIAN-R BLACK  
Obj. kód 63000611



ARIAN-S TRANSP  
Obj. kód 63000612



ARIAN-S BLACK  
Obj. kód 63000613

obj. kód	typ	farba	rozmer (mm)	otvor (mm)
63000610	ARIAN-R TRANSP	transparentná	D90x20	D65
63000611	ARIAN-R BLACK	čierna	D90x20	D65
63000612	ARIAN-S TRANSP	transparentná	90x90x20	D65
63000613	ARIAN-S BLACK	čierna	90x90x20	D65

## ARIAN

materiál:  
kov, sklo

MR16

50 W

12 V

IP 20





## Podhľadové

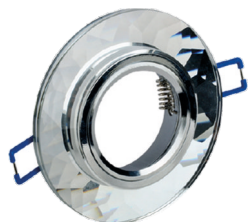

PALACE-1 R CHROME  
Obj. kód 2012100

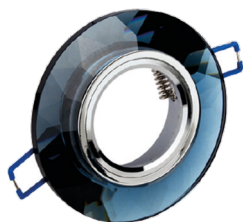

PALACE-1 R BLACK  
Obj. kód 2012110

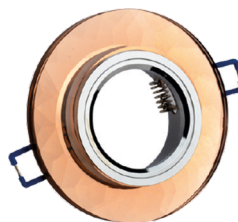

PALACE-1 R COPPER  
Obj. kód 2012120

### PALACE

materiál:  
kov, sklo

GX 5,3

50 W

12 V

IP 20

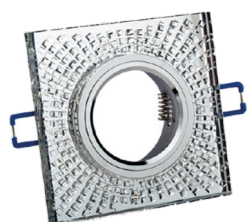

PALACE-2 R CHROME  
Obj. kód 2012130



PALACE-2 R CHROME  
Obj. kód 2012140



PALACE-3 R CHROME  
Obj. kód 2012150

obj. kód	typ	farba	rozmer (mm)	otvor (mm)
2012100	PALACE-1 R CHROME	chróm/číra	D95x22	D60
2012110	PALACE-1 R BLACK	chróm/čierna	D95x22	D60
2012120	PALACE-1 R COPPER	chróm/medená	D95x22	D60
2012130	PALACE-2 S CHROME	chróm/číra	95x95x22	D60
2012140	PALACE-2 R CHROME	chróm/číra	D95x22	D60
2012150	PALACE-3 R CHROME	chróm/číra	D95x30	D60

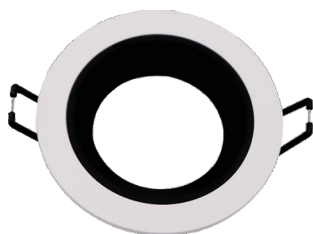

OLA-D01 WHT-BLC  
Obj. kód 2012540



OLA-D00 WHT  
Obj. kód 2012550

### OLA-D

materiál:  
hliník, akryl

GU10

50 W

220-240 V

50/60 Hz

IP 20



OLA-D11 BLC  
Obj. kód 2012560

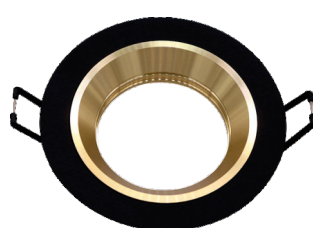

OLA-D12 BLC-GLD  
Obj. kód 2012570

obj. kód	typ	farba	rozmer (mm)	otvor (mm)
2012540	OLA-D01 WHT-BLC	bielo-čierna	D90x28	D60
2012550	OLA-D00 WHT	biela	D90x28	D60
2012560	OLA-D11 BLC	čierna	D90x28	D60
2012570	OLA-D12 BLC-GLD	čierno-zlatá	D90x28	D60



DONNA-10 WHT  
Obj. kód 2012760

## DONNA-10

materiál:  
hliník, akryl

GU10

50 W

220-240 V

50/60 Hz

IP 20



obj. kód	typ	farba	rozmer (mm)	otvor (mm)
2012760	DONNA-10 WHT	biela	D78x40	D65



OLA-S01 WHT-BLC  
Obj. kód 2012630



OLA-S00 WHT  
Obj. kód 2012640



OLA-S11 BLC  
Obj. kód 2012650



OLA-S12 BLC-BRS  
Obj. kód 2012660

## OLA-S

materiál:  
hliník, akryl

GU10

50 W

220-240 V

50/60 Hz

IP 20



obj. kód	typ	farba	rozmer (mm)
2012630	OLA-S01 WHT-BLC	bielo-čierna	D85x81
2012640	OLA-S00 WHT	biela	D85x81
2012650	OLA-S11 BLC	čierna	D85x81
2012660	OLA-S12 BLC-BRS	čierno-medená	D85x81



# Tuby

## DONNA-AB

materiál:  
hliník, akryl

GU10

50 W

220-240 V

50/60 Hz

IP 20



DONNA-AB WHT  
Obj. kód 2012850



DONNA-AB BLC  
Obj. kód 2012860

obj. kód	typ	farba	rozmer (mm)
2012850	DONNA-AB WHT	biela	D80x145
2012860	DONNA-AB BLC	čierna-biela	D80x145

## DONNA-AS

materiál:  
hliník, akryl

GU10

50 W

220-240 V

50/60 Hz

IP 20



DONNA-AS WHT  
Obj. kód 2012830



DONNA-AS BLC  
Obj. kód 2012840

obj. kód	typ	farba	rozmer (mm)
2012830	DONNA-AS WHT	biela	D65x112
2012840	DONNA-AS BLC	čierna-biela	D65x112



DONNA-BB WHT  
Obj. kód 2012870



DONNA-BB BLC  
Obj. kód 2012880

## DONNA-BB

materiál:  
hliník, akryl

GU10

50 W

220-240 V

50/60 Hz

IP 20



obj. kód	typ	farba	rozmer (mm)
2012870	DONNA-BB WHT	biela	D80x145
2012880	DONNA-BB BLC	čierna-biela	D80x145



FABRI GU10 BL  
Obj. kód 319883



FABRI GU10 CN  
Obj. kód 319890

## FABRI

materiál:  
hliník, akryl

GU10

10 W

220-240 V

50/60 Hz

IP 20



obj. kód	typ	farba	rozmer (mm)
319883	FABRI GU10 BL	biela	D70x110
319890	FABRI GU10 CN	čierna	D70x110



# Tuby

## RUBIN

materiál:  
hliník

GU10

10 W

220-240 V

50/60 Hz

IP 20



RUBIN-RO GU10 BL  
Obj. kód 319821



RUBIN-RO GU10 CN  
Obj. kód 319838



RUBIN-PA GU10 BL  
Obj. kód 319845



RUBIN-PA GU10 CN  
Obj. kód 319852



obj. kód	typ	farba	rozmer (mm)
319821	RUBIN-RO GU10 BL	biela	D80x100
319838	RUBIN-RO GU10 CN	čierna	D80x100
319845	RUBIN-PA GU10 BL	biela	D80x100
319852	RUBIN-PA GU10 CN	čierna	D80x100

## HOLA

materiál:  
hliník

GU10

220-240 V

50/60 Hz

IP 20



HOLA-WHT  
Obj. kód 2102850



HOLA-BLC  
Obj. kód 2102840

obj. kód	typ	farba	rozmer (mm)
2102850	HOLA-WHT	biela	D70x106
2102840	HOLA-BLC	čierna	D70x106

# Tuby



FINO-R GU10 BLACK  
Obj. kód 2026890



FINO-R GU10 WHITE  
Obj. kód 2026900



FINO-R GU10 WHITE-GOLD  
Obj. kód 2026910



FINO-R GU10 BLACK-GOLD  
Obj. kód 2026920

obj. kód	typ	farba	rozmer (mm)
2026890	FINO-R GU10 BLACK	čierna	D80x140
2026900	FINO-R GU10 WHITE	biela	D80x140
2026910	FINO-R GU10 WHITE-GOLD	biela, zlatá	D80x140
2026920	FINO-R GU10 BLACK-GOLD	čierna, zlatá	D80x140

## FINO-R

materiál:  
hliník

GU10

220-240 V

50/60 Hz

IP 20



FINO-S GU10 WHITE-BLACK  
Obj. kód 2026930



FINO-S GU10 BLACK  
Obj. kód 2026940



FINO-S GU10 WHITE  
Obj. kód 2026950



FINO-S GU10 WHITE-GOLD  
Obj. kód 2026960

obj. kód	typ	farba	rozmer (mm)
2026930	FINO-S GU10 WHITE-BLACK	biela, čierna	74x74x140
2026940	FINO-S GU10 BLACK	čierna	74x74x140
2026950	FINO-S GU10 WHITE	biela	74x74x140
2026960	FINO-S GU10 WHITE-GOLD	biela, zlatá	74x74x140

## FINO-S

materiál:  
hliník

GU10

220-240 V

50/60 Hz

IP 20





# Tuby

## AMAT-M

materiál:  
kov

GU10

35 W

230 V

50 Hz

IP 20



AMAT-M BLACK-R  
Obj. kód 63000621



AMAT-M WHITE-R  
Obj. kód 63000620



AMAT-M BLACK-S  
Obj. kód 63000626



AMAT-M WHITE-S  
Obj. kód 63000625

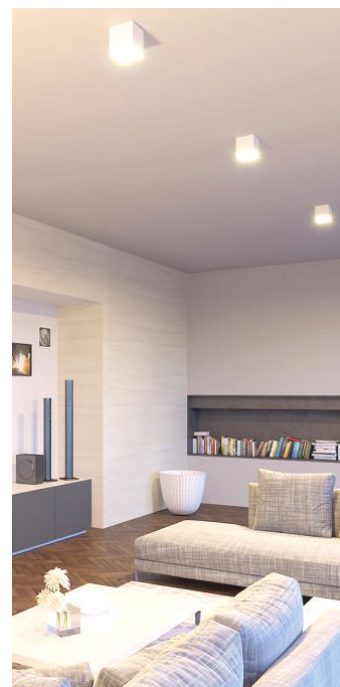

obj. kód	typ	farba	rozmer (mm)
63000621	AMAT-M BLACK-R	čierna	D80x84
63000620	AMAT-M WHITE-R	biela	D80x84
63000626	AMAT-M BLACK-S	čierna	80x80x84
63000625	AMAT-M WHITE-S	biela	80x80x84

## OH36-S

## OH37-S

materiál: kov

LED  
modul

230 V

50 Hz

max 35W

IP 20



OH36-S WHITE  
Obj. kód 63000705



OH36-S BLACK  
Obj. kód 63000706



OH36-S CHR  
Obj. kód 63000707



OH37-S BLACK  
Obj. kód 63000710

obj. kód	typ	farba	rozmer (mm)
63000705	OH36-S WHITE	biela	D80x50
63000706	OH36-S BLACK	čierna	D80x50
63000707	OH36-S CHR	brúsený hliník	D80x50
63000710	OH37-S BLACK	čierna	80x80x50

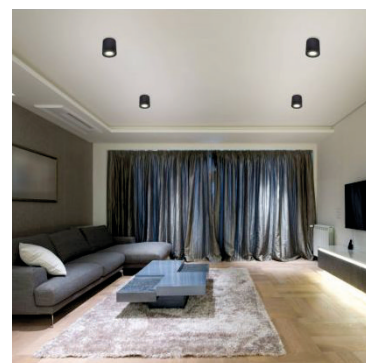
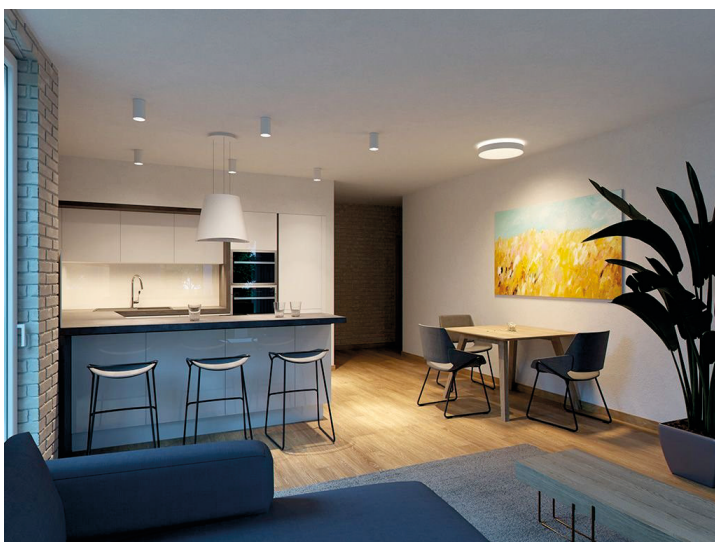



# TRACK systém



MAGNA-S1



MAGNA-S2



MAGNA-S5



MAGNA-S3



MAGNA-S4



## MAGNA

materiál:  
hliník, plast

LED

48 V

IP 20

Ra >80

25000 h



### Svietidlo

obj. kód	typ	W	lm	uhol	farba	rozmer (mm)
2102120	MAGNA-S1 12W 3000K	12	960	15°	čierna	D50x120
2102130	MAGNA-S1 12W 4000K	12	984	15°	čierna	D50x120
2102140	MAGNA-S1 20W 3000K	20	1600	24°	čierna	D60x140
2102150	MAGNA-S1 20W 4000K	20	1640	24°	čierna	D60x140
2102160	MAGNA-S1 30W 3000K	30	2400	24°	čierna	D70x160
2102170	MAGNA-S1 30W 4000K	30	2460	24°	čierna	D70x160
2102080	MAGNA-S2 12W 3000K	12	960	36°	čierna	220x22x25
2102090	MAGNA-S2 12W 4000K	12	984	36°	čierna	220x22x25
2102100	MAGNA-S2 18W 3000K	18	1440	36°	čierna	330x22x25
2102110	MAGNA-S2 18W 4000K	18	1476	36°	čierna	330x22x25
2102180	MAGNA-S3 6W 3000K	6	480	24°	čierna	110x22x110
2102190	MAGNA-S3 6W 4000K	6	492	24°	čierna	110x22x110
2102200	MAGNA-S3 12W 3000K	12	960	24°	čierna	220x22x110
2102210	MAGNA-S3 12W 4000K	12	984	24°	čierna	220x22x110
2102000	MAGNA-S4 10W 3000K	10	800	120°	čierna	300x22x25
2102010	MAGNA-S4 10W 4000K	10	820	120°	čierna	300x22x25
2102020	MAGNA-S4 20W 3000K	20	1600	120°	čierna	600x22x25
2102030	MAGNA-S4 20W 4000K	20	1640	120°	čierna	600x22x25
2102040	MAGNA-S4 30W 3000K	30	2400	120°	čierna	900x22x25
2102050	MAGNA-S4 30W 4000K	30	2460	120°	čierna	900x22x25
2102060	MAGNA-S4 40W 3000K	40	3200	120°	čierna	1200x22x25
2102070	MAGNA-S4 40W 4000K	40	3280	120°	čierna	1200x22x25
2102220	MAGNA-S5 12W 3000K	12	960	24°	čierna	D40x300
2102230	MAGNA-S5 12W 4000K	12	984	24°	čierna	D40x300

# TRACK systém



MAGNA-S20-Z 1M BLACK  
MAGNA-S20-Z 2M BLACK



MAGNA-S20-P 1M BLACK  
MAGNA-S20-P 2M BLACK



MAGNA-R30 BLACK VER



MAGNA-CI BLACK



MAGNA-SCI BLACK



MAGNA-R20 BLACK



MAGNA-S1 BLACK



MAGNA-PE BLACK

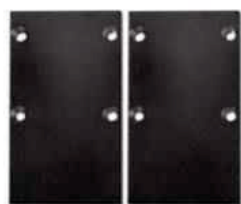

MAGNA-C BLACK



MAGNA-PS BLACK 100W  
MAGNA-PS BLACK 200W

## Príslušenstvo

obj. kód	typ	príslušenstvo	farba	rozmer (mm)
9910720	MAGNA-S20-Z 1M BLACK	lišta magnetic zápustná	čierna	1000x53x26
9910730	MAGNA-S20-Z 2M BLACK	lišta magnetic zápustná	čierna	2000x53x26
9910700	MAGNA-S20-P 1M BLACK	lišta magnetic povrchová	čierna	1000x53x26
9910710	MAGNA-S20-P 2M BLACK	lišta magnetic povrchová	čierna	2000x53x26
9910800	MAGNA-R30 BLACK VER	spojka rohová zápustná vertikálna	čierna	-
9910770	MAGNA-CI BLACK	konektor rohový	čierna	-
9910780	MAGNA-SCI BLACK	spojka rohová povrchová	čierna	-
9910790	MAGNA-R20 BLACK	spojka rohová zápustná	čierna	-
9910760	MAGNA-S1 BLACK	konektor rovný	čierna	-
9910750	MAGNA-PE BLACK	záves	-	-
9910740	MAGNA-C BLACK	koncovka	čierna	-

## Napájacie zdroje

obj. kód	typ	U vstup	U výstup	Hz	W	IP
9910810	MAGNA-PS BLACK 100W	220-240 V	48V	50/60 Hz	100	20
9910820	MAGNA-PS BLACK 200W	220-240 V	48V	50/60 Hz	200	20

## MAGNA PRÍSLUŠENSTVO

materiál:  
hliník

48 V





# TRACK systém



## TRACK

materiál:  
hliník, plast

LED/GU10

180-240 V

50/60 Hz

4500 K

IP 20

Ra >80

30000 h



### Svietidlo

obj. kód	typ	W	lm	pätica	farba	rozmer (mm)
2101670	SUN-P2 12W 4500K BLACK	12	876	-	čierna	D54x200
2101690	SUN-P2 12W 4500K WHITE	12	876	-	biela	D54x200
2101730	SUN-G2 20W 4500K BLACK	20	1660	-	čierna	D65x160
2101770	SUN-G2 20W 4500K WHITE	20	1660	-	biela	D65x160
2101810	SUN-G3 30W 4500K BLACK	30	2490	-	čierna	D80x180
2101850	SUN-G3 30W 4500K WHITE	30	2490	-	biela	D80x180
2102800	LUMO-N GU10 BLACK	max. 30 W	-	GU10	čierna	D60x100
2102810	LUMO-N GU10 WHITE	max. 30 W	-	GU10	biela	D60x100
63000641	TRACK-Z GU10 CN	max. 30 W	-	GU10	čierna	D60x240x1300
63000640	TRACK-Z GU10 BL	max. 30 W	-	GU10	biela	D60x240x1300
321602	TRACK-2 PARIS GU10 BL	max. 10 W	-	GU10	biela	D55xmax 190
321619	TRACK-2 PARIS GU10 CN	max. 10 W	-	GU10	čierna	D55xmax 190
321701	TRACK-2 MARIBEL GU10 BL+ZT	max. 10 W	-	GU10	biela, zlatá	75x68x215
321718	TRACK-2 MARIBEL GU10 CN+ZT	max. 10 W	-	GU10	čierna, zlatá	75x68x215

### Príslušenstvo

obj. kód	typ	príslušenstvo	farba	rozmer (mm)
9902670	TRACK PT1 1M WHITE	lišta	biela	1000
9902680	TRACK PT1 1M BLACK	lišta	čierna	1000
9902690	TRACK PT1 2M WHITE	lišta	biela	2000
9902700	TRACK PT1 2M BLACK	lišta	čierna	2000
9902570	APT-1 SQUARE WHITE	spojka	biela	
9902580	APT-1 SQUARE BLACK	spojka	čierna	
9902590	APT-1 T-TYPE WHITE	spojka	biela	
9902600	APT-1 T-TYPE BLACK	spojka	čierna	
9902610	APT-1 CROSS WHITE	spojka	biela	
9902620	APT-1 CROSS BLACK	spojka	čierna	
9902630	APT-1 LINEAR WHITE	spojka	biela	
9902640	APT-1 LINEAR BLACK	spojka	čierna	
9902650	APT-1 FLEXI WHITE	spojka	biela	
9902660	APT-1 FLEXI BLACK	spojka	čierna	

provided by  
**SAMSUNG**

NAPÁJACÍ ZDROJ

**PHILIPS  
TRIDONIC  
OSRAM**

NA ZÁKLADE  
POŽIADAVKY MOŽNOSŤ  
STMIEVANIA

0 – 10 V, DALI

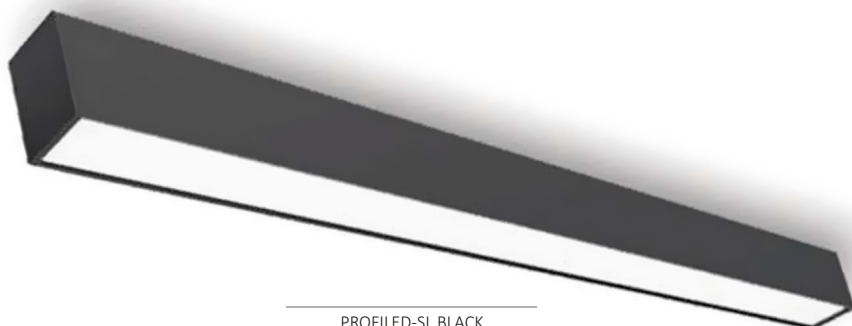

PROFILED-SL BLACK

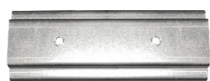

PROFILED SL CONNECTOR



PROFILED HANGING-SET BL



PROFILED-SL-L BL



PROFILED-SL-T BL

## Svietidlo

obj. kód	typ	W	lm	farba	rozmer (mm)
2427700	PROFILED-SL 20W 3000K BL 60CM	20	2000	čierna	590x53x83
2427710	PROFILED-SL 20W 4000K BL 60CM	20	2100	čierna	590x53x83
2427720	PROFILED-SL 20W 6500K BL 60CM	20	2200	čierna	590x53x83
2427820	PROFILED-SL 32W 3000K BL 90CM	32	3200	čierna	890x53x83
2427830	PROFILED-SL 32W 4000K BL 90CM	32	3360	čierna	890x53x83
2427840	PROFILED-SL 32W 6500K BL 90CM	32	3520	čierna	890x53x83
2427940	PROFILED-SL 42W 3000K BL 120CM	42	4200	čierna	1200x53x83
2427950	PROFILED-SL 42W 4000K BL 120CM	42	4410	čierna	1200x53x83
2427960	PROFILED-SL 42W 6500K BL 120CM	42	4620	čierna	1200x53x83
2428060	PROFILED-SL 50W 3000K BL 150CM	50	5000	čierna	1490x53x83
2428070	PROFILED-SL 50W 4000K BL 150CM	50	5250	čierna	1490x53x83
2428080	PROFILED-SL 50W 6500K BL 150CM	50	5500	čierna	1490x53x83
2428180	PROFILED-SL 66W 3000K BL 200CM	66	6600	čierna	2000x53x83
2428190	PROFILED-SL 66W 4000K BL 200CM	66	6930	čierna	2000x53x83
2428200	PROFILED-SL 66W 6500K BL 200CM	66	7260	čierna	2000x53x83



## Príslušenstvo

obj. kód	typ	príslušenstvo	W	lm	farba	rozmer (mm)
9910010	PROFILED-SL CONNECTOR	spojka	-	-	šedá	-
9910020	PROFILED HANGING-SET BL	záves	-	-	čierna	-
2429140	PROFILED-SL-L 9W 3000K BL 25x25CM	L spojka	9	900	čierna	250x250x53
2429150	PROFILED-SL-L 9W 4000K BL 25x25CM	L spojka	9	945	čierna	250x250x53
2429160	PROFILED-SL-L 9W 6500K BL 25x25CM	L spojka	9	990	čierna	250x250x53
2429380	PROFILED-SL-T 9W 3000K BL 25x25CM	T spojka	9	900	čierna	250x250x53
2429390	PROFILED-SL-T 9W 4000K BL 25x25CM	T spojka	9	945	čierna	250x250x53
2429400	PROFILED-SL-T 9W 6500K BL 25x25CM	T spojka	9	990	čierna	250x250x53

## PROFILED-SL

materiál:  
hliník, PC

LED

220-240 V

50/60 Hz

IP 40

Ra >80

50000 h





# Lineárne



PROFILED-SL WHITE

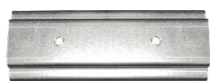
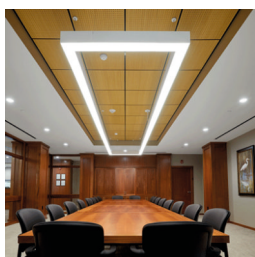
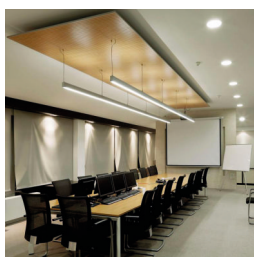
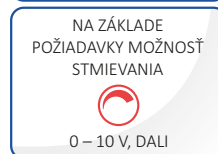

PROFILED SL CONNECTOR



PROFILED HANGING-SET WH



PROFILED-SL-L WH



PROFILED-SL-T WH

## Svietidlo

obj. kód	typ	W	lm	farba	rozmer (mm)
2427100	PROFILED-SL 20W 3000K WH 60CM	20	2000	biela	590x53x83
2427110	PROFILED-SL 20W 4000K WH 60CM	20	2100	biela	590x53x83
2427120	PROFILED-SL 20W 6500K WH 60CM	20	2200	biela	590x53x83
2427220	PROFILED-SL 32W 3000K WH 90CM	32	3200	biela	890x53x83
2427230	PROFILED-SL 32W 4000K WH 90CM	32	3360	biela	890x53x83
2427240	PROFILED-SL 32W 6500K WH 90CM	32	3520	biela	890x53x83
2427340	PROFILED-SL 42W 3000K WH 120CM	42	4200	biela	1200x53x83
2427350	PROFILED-SL 42W 4000K WH 120CM	42	4410	biela	1200x53x83
2427360	PROFILED-SL 42W 6500K WH 120CM	42	4620	biela	1200x53x83
2427460	PROFILED-SL 50W 3000K WH 150CM	50	5000	biela	1490x53x83
2427470	PROFILED-SL 50W 4000K WH 150CM	50	5250	biela	1490x53x83
2427480	PROFILED-SL 50W 6500K WH 150CM	50	5500	biela	1490x53x83
2427580	PROFILED-SL 66W 3000K WH 200CM	66	6600	biela	2000x53x83
2427590	PROFILED-SL 66W 4000K WH 200CM	66	6930	biela	2000x53x83
2427600	PROFILED-SL 66W 6500K WH 200CM	66	7260	biela	2000x53x83

## PROFILED-SL

materiál:  
hliník, PC

LED

220-240 V

50/60 Hz

IP 40

Ra >80



50000 h



## Príslušenstvo

obj. kód	typ	príslušenstvo	W	lm	farba	rozmer (mm)
9910010	PROFILED-SL CONNECTOR	spojka	-	-	šedá	-
9910030	PROFILED HANGING-SET WH	záves	-	-	biela	-
2429020	PROFILED-SL-L 9W 3000K WH 25x25CM	L spojka	9	900	biela	250x250x53
2429030	PROFILED-SL-L 9W 4000K WH 25x25CM	L spojka	9	945	biela	250x250x53
2429040	PROFILED-SL-L 9W 6500K WH 25x25CM	L spojka	9	990	biela	250x250x53
2429260	PROFILED-SL-T 9W 3000K WH 25x25CM	T spojka	9	900	biela	250x250x53
2429270	PROFILED-SL-T 9W 4000K WH 25x25CM	T spojka	9	945	biela	250x250x53
2429280	PROFILED-SL-T 9W 6500K WH 25x25CM	T spojka	9	990	biela	250x250x53

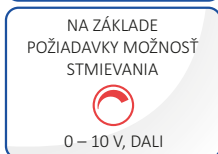

PROFILED-SL GRY

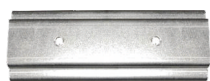

PROFILED SL CONNECTOR



PROFILED HANGING-SET GRY



PROFILED-SL-L GRY



PROFILED-SL-T GRY

## Svietidlo

obj. kód	typ	W	lm	farba	rozmer (mm)
2424780	PROFILED-SL 20W 3000K GRY 60CM	20	2000	šedá	590x53x83
2424790	PROFILED-SL 20W 4000K GRY 60CM	20	2100	šedá	590x53x83
2424800	PROFILED-SL 20W 6500K GRY 60CM	20	2200	šedá	590x53x83
2424810	PROFILED-SL 32W 3000K GRY 90CM	32	3200	šedá	890x53x83
2424820	PROFILED-SL 32W 4000K GRY 90CM	32	3360	šedá	890x53x83
2424830	PROFILED-SL 32W 6500K GRY 90CM	32	3520	šedá	890x53x83
2424840	PROFILED-SL 42W 3000K GRY 120CM	42	4200	šedá	1200x53x83
2424850	PROFILED-SL 42W 4000K GRY 120CM	42	4410	šedá	1200x53x83
2424860	PROFILED-SL 42W 6500K GRY 120CM	42	4620	šedá	1200x53x83
2424870	PROFILED-SL 50W 3000K GRY 150CM	50	5000	šedá	1490x53x83
2424880	PROFILED-SL 50W 4000K GRY 150CM	50	5250	šedá	1490x53x83
2424890	PROFILED-SL 50W 6500K GRY 150CM	50	5500	šedá	1490x53x83
2424900	PROFILED-SL 66W 3000K GRY 200CM	66	6600	šedá	2000x53x83
2424910	PROFILED-SL 66W 4000K GRY 200CM	66	6930	šedá	2000x53x83
2424920	PROFILED-SL 66W 6500K GRY 200CM	66	7260	šedá	2000x53x83



## Príslušenstvo

obj. kód	typ	príslušenstvo	W	lm	farba	rozmer (mm)
9910010	PROFILED-SL CONNECTOR	spojka	-	-	šedá	-
9910040	PROFILED HANGING-SET GRY	záves	-	-	šedá	-
9910430	PROFILED-SL-L 9W 3000K GRY 25x25CM	L spojka	9	900	šedá	250x250x53
9910440	PROFILED-SL-L 9W 4000K GRY 25x25CM	L spojka	9	945	šedá	250x250x53
9910450	PROFILED-SL-L 9W 6500K GRY 25x25CM	L spojka	9	990	šedá	250x250x53
9910520	PROFILED-SL-T 9W 3000K GRY 25x25CM	T spojka	9	900	šedá	250x250x53
9910530	PROFILED-SL-T 9W 4000K GRY 25x25CM	T spojka	9	945	šedá	250x250x53
9910540	PROFILED-SL-T 9W 6500K GRY 25x25CM	T spojka	9	990	šedá	250x250x53

## PROFILED-SL

materiál:  
hliník, PC

LED

220-240 V

50/60 Hz

IP 40

Ra >80

50000 h





# Lineárne

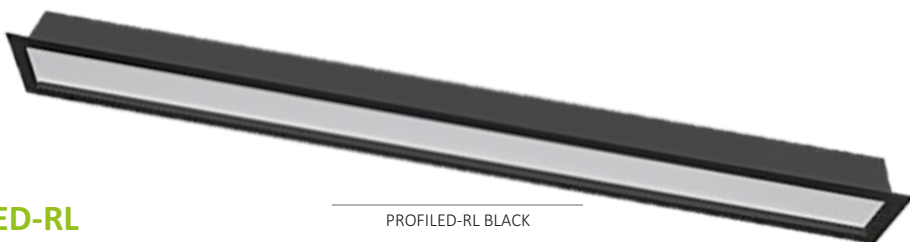

PROFILED-RL BLACK



PROFILED-RL-L BL

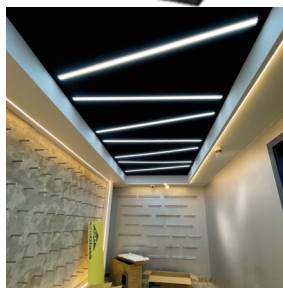

## PROFILED-RL

materiál:  
hliník, PC

LED

220-240 V

50/60 Hz

IP 40

Ra >80

50000 h



### Svietidlo

obj. kód	typ	W	lm	farba	montáž	rozmer (mm)
2428300	PROFILED-RL 20W 3000K BL 60CM	20	2000	čierna	zapustená	590x65x45
2428310	PROFILED-RL 20W 4000K BL 60CM	20	2100	čierna	zapustená	590x65x45
2428320	PROFILED-RL 20W 6500K BL 60CM	20	2200	čierna	zapustená	590x65x45
2428420	PROFILED-RL 42W 3000K BL 120CM	42	4200	čierna	zapustená	1200x65x45
2428430	PROFILED-RL 42W 4000K BL 120CM	42	4410	čierna	zapustená	1200x65x45
2428440	PROFILED-RL 42W 6500K BL 120CM	42	4620	čierna	zapustená	1200x65x45

### Príslušenstvo

obj. kód	typ	príslušenstvo	W	lm	farba	rozmer (mm)
2428900	PROFILED-RL-L 9W 3000K BL 25x25CM	L spojka zápustná	9	900	čierna	250x250x65
2428910	PROFILED-RL-L 9W 4000K BL 25x25CM	L spojka zápustná	9	945	čierna	250x250x65
2428920	PROFILED-RL-L 9W 6500K BL 25x25CM	L spojka zápustná	9	990	čierna	250x250x65



NAPÁJACÍ ZDROJ

PHILIPS  
TRIDONIC  
OSRAM

NA ZÁKLADE  
POŽIADAVKY MOŽNOSŤ  
STMIEVANIA



0 – 10 V, DALI



PROFILED-RL WHITE



PROFILED-RL-L WH

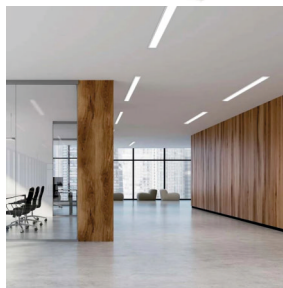

## PROFILED-RL

materiál:  
hliník, PC

LED

220-240 V

50/60 Hz

IP 40

Ra >80

50000 h



### Svietidlo

obj. kód	typ	W	lm	farba	montáž	rozmer (mm)
2428540	PROFILED-RL 20W 3000K WH 60CM	20	2000	biela	zapustená	590x65x45
2428550	PROFILED-RL 20W 4000K WH 60CM	20	2100	biela	zapustená	590x65x45
2428560	PROFILED-RL 20W 6500K WH 60CM	20	2200	biela	zapustená	590x65x45
2428660	PROFILED-RL 42W 3000K WH 120CM	42	4200	biela	zapustená	1200x65x45
2428670	PROFILED-RL 42W 4000K WH 120CM	42	4410	biela	zapustená	1200x65x45
2428680	PROFILED-RL 42W 6500K WH 120CM	42	4620	biela	zapustená	1200x65x45

### Príslušenstvo

obj. kód	typ	príslušenstvo	W	lm	farba	rozmer (mm)
2428780	PROFILED-RL-L 9W 3000K WH 25x25CM	L spojka zápustná	9	900	biela	250x250x65
2428790	PROFILED-RL-L 9W 4000K WH 25x25CM	L spojka zápustná	9	945	biela	250x250x65
2428800	PROFILED-RL-L 9W 6500K WH 25x25CM	L spojka zápustná	9	990	biela	250x250x65



NAPÁJACÍ ZDROJ

PHILIPS  
TRIDONIC  
OSRAM

NA ZÁKLADE  
POŽIADAVKY MOŽNOSŤ  
STMIEVANIA



0 – 10 V, DALI



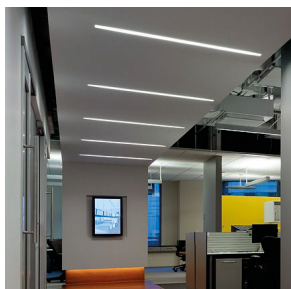
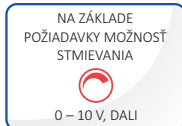

PROFILED-RL GRY



PROFILED-RL-L GRY

## PROFILED-RL

materiál:  
hliník, PC

LED

220-240 V

50/60 Hz

IP 40

Ra &gt;80

50000 h



## Svietidlo

obj. kód	typ	W	lm	farba	montáž	rozmer (mm)
2424960	PROFILED-RL 20W 3000K GRY 60CM	20	2000	šedá	zapustená	590x65x45
2424970	PROFILED-RL 20W 4000K GRY 60CM	20	2100	šedá	zapustená	590x65x45
2424980	PROFILED-RL 20W 6500K GRY 60CM	20	2200	šedá	zapustená	590x65x45
2425050	PROFILED-RL 42W 3000K GRY 120CM	42	4200	šedá	zapustená	1200x65x45
2425060	PROFILED-RL 42W 4000K GRY 120CM	42	4410	šedá	zapustená	1200x65x45
2425070	PROFILED-RL 42W 6500K GRY 120CM	42	4620	šedá	zapustená	1200x65x45

## Príslušenstvo

obj. kód	typ	príslušenstvo	W	lm	farba	rozmer (mm)
9910160	PROFILED-RL-L 9W 3000K GRY 25x25CM	L spojka zápusťná	9	900	šedá	250x250x65
9910170	PROFILED-RL-L 9W 4000K GRY 25x25CM	L spojka zápusťná	9	945	šedá	250x250x65
9910180	PROFILED-RL-L 9W 6500K GRY 25x25CM	L spojka zápusťná	9	990	šedá	250x250x65

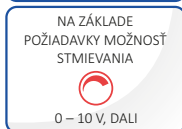

PROFILED-PC WHITE

## PROFILED-PC

materiál:  
hliník, PC

LED

220-240 V

50/60 Hz

IP 40

Ra &gt;80

50000 h



Súčasťou balenia je 1,5 m dlhý lankový záves.

## Svietidlo

obj. kód	typ	W	lm	farba	rozmer (mm)
2423820	PROFILED-PC 46W 3000K WH 60CM	46	5980	biela	D600x80x80
2423830	PROFILED-PC 46W 4000K WH 60CM	46	6164	biela	D600x80x80
2423840	PROFILED-PC 46W 6500K WH 60CM	46	6348	biela	D600x80x80
2423850	PROFILED-PC 72W 3000K WH 90CM	72	9360	biela	D900x80x80
2423860	PROFILED-PC 72W 4000K WH 90CM	72	9648	biela	D900x80x80
2423870	PROFILED-PC 72W 6500K WH 90CM	72	9936	biela	D900x80x80
2423880	PROFILED-PC 96W 3000K WH 120CM	96	12480	biela	D1200x80x80
2423890	PROFILED-PC 96W 4000K WH 120CM	96	12864	biela	D1200x80x80
2423900	PROFILED-PC 96W 6500K WH 120CM	96	13248	biela	D1200x80x80



# Lineárne

## PROFILED-PC

materiál:  
hliník, PC

LED

220-240 V

50/60 Hz

IP 40

Ra >80

50000 h



PROFILED-PC BLACK

Súčasťou balenia je 1,5 m dlhý lankový záves.

### Svietidlo

obj. kód	typ	W	lm	farba	rozmer (mm)
2423910	PROFILED-PC 46W 3000K BL 60CM	46	5980	čierna	D600x80x80
2423920	PROFILED-PC 46W 4000K BL 60CM	46	6164	čierna	D600x80x80
2423930	PROFILED-PC 46W 6500K BL 60CM	46	6348	čierna	D600x80x80
2423940	PROFILED-PC 72W 3000K BL 90CM	72	9360	čierna	D900x80x80
2423950	PROFILED-PC 72W 4000K BL 90CM	72	9648	čierna	D900x80x80
2423960	PROFILED-PC 72W 6500K BL 90CM	72	9936	čierna	D900x80x80
2423970	PROFILED-PC 96W 3000K BL 120CM	96	12480	čierna	D1200x80x80
2423980	PROFILED-PC 96W 4000K BL 120CM	96	12864	čierna	D1200x80x80
2423990	PROFILED-PC 96W 6500K BL 120CM	96	13248	čierna	D1200x80x80



NAPÁJACÍ ZDROJ  
**PHILIPS TRIDONIC OSRAM**

NA ZÁKLADE  
POŽIADAVKY MOŽNOSŤ  
STMIEVANIA  
0 – 10 V, DALI



## PROFILED-PR

materiál:  
hliník, PC

LED

220-240 V

50/60 Hz

IP 40

Ra >80

50000 h



PROFILED-PR WHITE

Súčasťou balenia je 1,5 m dlhý lankový záves.

### Svietidlo

obj. kód	typ	W	lm	farba	rozmer (mm)
2423550	PROFILED-PR 50W 3000K WH 60CM	50	7800	biela	D600x80
2423560	PROFILED-PR 50W 4000K WH 60CM	50	8040	biela	D600x80
2423570	PROFILED-PR 50W 6500K WH 60CM	50	8280	biela	D600x80
2423580	PROFILED-PR 100W 3000K WH 90CM	100	11700	biela	D900x80
2423590	PROFILED-PR 100W 4000K WH 90CM	100	12060	biela	D900x80
2423600	PROFILED-PR 100W 6500K WH 90CM	100	12420	biela	D900x80



NAPÁJACÍ ZDROJ  
**PHILIPS TRIDONIC OSRAM**

NA ZÁKLADE  
POŽIADAVKY MOŽNOSŤ  
STMIEVANIA  
0 – 10 V, DALI





PROFILED-PR GRY

Súčasťou balenia je 1,5 m dlhý lankový záves.

## PROFILED-PR

materiál:  
hliník, PC

LED

220-240 V

50/60 Hz

IP 40

Ra >80

50000 h



### Svietidlo

obj. kód	typ	W	lm	farba	rozmer (mm)
2423730	PROFILED-PR 50W 3000K GRY 60CM	50	7800	šedá	D600x80
2423740	PROFILED-PR 50W 4000K GRY 60CM	50	8040	šedá	D600x80
2423750	PROFILED-PR 50W 6500K GRY 60CM	50	8280	šedá	D600x80
2423760	PROFILED-PR 100W 3000K GRY 90CM	100	11700	šedá	D900x80
2423770	PROFILED-PR 100W 4000K GRY 90CM	100	12060	šedá	D900x80
2423780	PROFILED-PR 100W 6500K GRY 90CM	100	12420	šedá	D900x80



PROFILED-PR BLACK

Súčasťou balenia je 1,5 m dlhý lankový záves.

## PROFILED-PR

materiál:  
hliník, PC

LED

220-240 V

50/60 Hz

IP 40

Ra >80

50000 h



### Svietidlo

obj. kód	typ	W	lm	farba	rozmer (mm)
2423640	PROFILED-PR 50W 3000K BL 60CM	50	7800	čierna	D600x80
2423650	PROFILED-PR 50W 4000K BL 60CM	50	8040	čierna	D600x80
2423660	PROFILED-PR 50W 6500K BL 60CM	50	8280	čierna	D600x80
2423670	PROFILED-PR 100W 3000K BL 90CM	100	11700	čierna	D900x80
2423680	PROFILED-PR 100W 4000K BL 90CM	100	12060	čierna	D900x80
2423690	PROFILED-PR 100W 6500K BL 90CM	100	12420	čierna	D900x80



## PROFILED-PS

materiál:  
hliník, PC

LED

220-240 V

50/60 Hz

IP 40

Ra >80

50000 h



PROFILED-PS 80W WHITE

Súčasťou balenia je 1,5 m dlhý lankový záves.



### Svietidlo

obj. kód	typ	W	lm	farba	rozmer (mm)
2423280	PROFILED-PS 60W 3000K WH 60CM	60	5980	biela	610x610x80
2423290	PROFILED-PS 60W 4000K WH 60CM	60	6164	biela	610x610x80
2423300	PROFILED-PS 60W 6500K WH 60CM	60	6348	biela	610x610x80
2423310	PROFILED-PS 80W 3000K WH 90CM	80	9360	biela	900x900x80
2423320	PROFILED-PS 80W 4000K WH 90CM	80	9648	biela	900x900x80
2423330	PROFILED-PS 80W 6500K WH 90CM	80	9936	biela	900x900x80
2423340	PROFILED-PS 110W 3000K WH 120CM	110	12480	biela	1180x1180x80
2423350	PROFILED-PS 110W 4000K WH 120CM	110	12864	biela	1180x1180x80
2423360	PROFILED-PS 110W 6500K WH 120CM	110	13248	biela	1180x1180x80



## PROFILED-PS

materiál:  
hliník, PC

LED

220-240 V

50/60 Hz

IP 40

Ra >80

50000 h

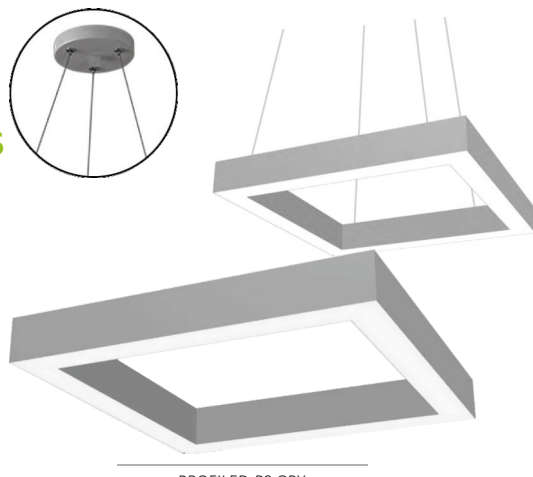

PROFILED-PS GRY

Súčasťou balenia je 1,5 m dlhý lankový záves.



### Svietidlo

obj. kód	typ	W	lm	farba	rozmer (mm)
2423460	PROFILED-PS 60W 3000K GRY 60CM	60	5980	šedá	610x610x80
2423470	PROFILED-PS 60W 4000K GRY 60CM	60	6164	šedá	610x610x80
2423480	PROFILED-PS 60W 6500K GRY 60CM	60	6348	šedá	610x610x80
2423490	PROFILED-PS 80W 3000K GRY 90CM	80	9360	šedá	900x900x80
2423500	PROFILED-PS 80W 4000K GRY 90CM	80	9648	šedá	900x900x80
2423510	PROFILED-PS 80W 6500K GRY 90CM	80	9936	šedá	900x900x80
2423520	PROFILED-PS 110W 3000K GRY 120CM	110	12480	šedá	1180x1180x80
2423530	PROFILED-PS 110W 4000K GRY 120CM	110	12864	šedá	1180x1180x80
2423540	PROFILED-PS 110W 6500K GRY 120CM	110	13248	šedá	1180x1180x80



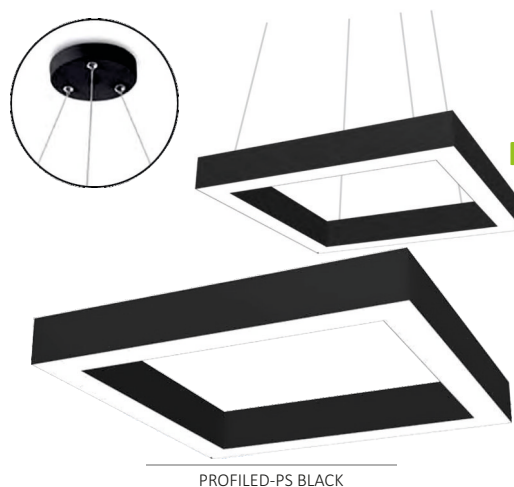

PROFILED-PS BLACK

Súčasťou balenia je 1,5 m dlhý lankový záves.

## PROFILED-PS

materiál:  
hliník, PC

LED

220-240 V

50/60 Hz

IP 40

Ra >80

50000 h



### Svietidlo

obj. kód	typ	W	lm	farba	rozmer (mm)
2423370	PROFILED-PS 60W 3000K BL 60CM	60	5980	čierna	610x610x80
2423380	PROFILED-PS 60W 4000K BL 60CM	60	6164	čierna	610x610x80
2423390	PROFILED-PS 60W 6500K BL 60CM	60	6348	čierna	610x610x80
2423400	PROFILED-PS 80W 3000K BL 90CM	80	9360	čierna	900x900x80
2423410	PROFILED-PS 80W 4000K BL 90CM	80	9648	čierna	900x900x80
2423420	PROFILED-PS 80W 6500K BL 90CM	80	9936	čierna	900x900x80
2423430	PROFILED-PS 110W 3000K BL 120CM	110	12480	čierna	1180x1180x80
2423440	PROFILED-PS 110W 4000K BL 120CM	110	12864	čierna	1180x1180x80
2423450	PROFILED-PS 110W 6500K BL 120CM	110	13248	čierna	1180x1180x80



FITLINE-60W 120cm WHITE,  
Obj. kód 3300150



FITLINE-60W 120CM BLACK,  
Obj. kód 3300160

## FITLINE

materiál:  
hliník, plast

LED

60 W

170-240 V

50/60 Hz

4000 K

IP 20

Ra >80

30000 h



obj. kód	typ	farba	lm	rozmer (mm)
3300150	FITLINE-60W 120CM WHITE	biela	6600	1200x50x60
3300160	FITLINE-60W 120CM BLACK	čierna	6600	1200x50x60

## LINETA

materiál: kov

LED

40 W

170-240 V

50/60 Hz

IP 40

Ra >80

50000 h



LINETA-40W 3000K WHITE, obj. kód 2429780  
LINETA-40W 4000K WHITE, obj. kód 2429790



LINETA-40W 3000K BLACK, obj. kód 2429810  
LINETA-40W 4000K BLACK, obj. kód 2429820

obj. kód	typ	farba	lm	farba svetla	rozmer (mm)
2429780	LINETA-40W 3000K WHITE	biela	4300	teplá	52x82x1200
2429790	LINETA-40W 4000K WHITE	biela	4400	neutrálna	52x82x1200
2429810	LINETA-40W 3000K BLACK	čierna	4300	teplá	52x82x1200
2429820	LINETA-40W 4000K BLACK	čierna	4400	neutrálna	52x82x1200



## MARIBEL

materiál:  
hliník

GU10

220-240 V

50/60 Hz

IP 20



MARIBEL 1xGU10 CN,  
Obj. kód 319906



MARIBEL 2xGU10 CN,  
Obj. kód 319913



MARIBEL 3xGU10 CN,  
Obj. kód 319920



MARIBEL 4xGU10 CN,  
Obj. kód 319937



MARIBEL-K 4xGU10 CN,  
Obj. kód 319944



MARIBEL 6xGU10 CN,  
Obj. kód 319951

obj. kód	typ	max. W	farba	rozmer (mm)
319906	MARIBEL 1xGU10 CN	1x 10 W	čierna, zlatá	D60x165
319913	MARIBEL 2xGU10 CN	2x 10 W	čierna, zlatá	D60x165x260
319920	MARIBEL 3xGU10 CN	3x 10 W	čierna, zlatá	D60x165x380
319937	MARIBEL 4xGU10 CN	4x 10 W	čierna, zlatá	D60x165x590
319944	MARIBEL-K 4xGU10 CN	4x 10 W	čierna, zlatá	260x165x260
319951	MARIBEL 6xGU10 CN	6x 10 W	čierna, zlatá	D60x165x1190





MARIBEL-1 GU10 BL+ZT,  
Obj. kód 321190



MARIBEL-2 GU10 BL+ZT,  
Obj. kód 321206



MARIBEL-3 GU10 BL+ZT,  
Obj. kód 321213



MARIBEL-4 GU10 BL+ZT,  
Obj. kód 321220



MARIBEL-4K GU10 BL+ZT,  
Obj. kód 321237



MARIBEL-6 GU10 BL+ZT,  
Obj. kód 321244

## MARIBEL

materiál:  
hliník

GU10

220-240 V

50/60 Hz

IP 20



obj. kód	typ	max. W	farba	rozmer (mm)
321190	MARIBEL-1 GU10 BL+ZT	1x 10 W	biela, zlatá	D60x165
321206	MARIBEL-2 GU10 BL+ZT	2x 10 W	biela, zlatá	60x165x260
321213	MARIBEL-3 GU10 BL+ZT	3x 10 W	biela, zlatá	60x165x380
321220	MARIBEL-4 GU10 BL+ZT	4x 10 W	biela, zlatá	60x165x590
321237	MARIBEL-4K GU10 BL+ZT	4x 10 W	biela, zlatá	260x165x260
321244	MARIBEL-6 GU10 BL+ZT	6x 10 W	biela, zlatá	60x165x1190



PARIS-1 GU10 BL,  
Obj. kód 322272



PARIS-3 GU10 BL,  
Obj. kód 322296



PARIS-2 GU10 BL,  
Obj. kód 322289



PARIS-4 GU10 BL,  
Obj. kód 322302



PARIS-6 GU10 BL,  
Obj. kód 322319

## PARIS

materiál:  
hliník

Gu10

220-240 V

50/60 Hz

IP 20



obj. kód	typ	max. W	farba	rozmer (mm)
322272	PARIS-1 GU10 BL	1x 10 W	biela	55x55x165
322289	PARIS-2 GU10 BL	2x 10 W	biela	55x165x260
322296	PARIS-3 GU10 BL	3x 10 W	biela	55x165x390
322302	PARIS-4 GU10 BL	4x 10 W	biela	55x165x595
322319	PARIS-6 GU10 BL	6x 10 W	biela	55x165x1195



## Interiérové



PARIS-1 GU10 CN,  
Obj. kód 322326



PARIS-3 GU10 CN,  
Obj. kód 322340



PARIS-2 GU10 CN,  
Obj. kód 322333



PARIS-4 GU10 CN,  
Obj. kód 322357



PARIS-6 GU10 CN,  
Obj. kód 322364

### PARIS

materiál:  
hliník

Gu10

220-240 V

50/60 Hz

IP 20



obj. kód	typ	max. W	farba	rozmer (mm)
322326	PARIS-1 GU10 CN	1x 10 W	čierna	55x55x165
322333	PARIS-2 GU10 CN	2x 10 W	čierna	55x165x260
322340	PARIS-3 GU10 CN	3x 10 W	čierna	55x165x390
322357	PARIS-4 GU10 CN	4x 10 W	čierna	55x165x595
322364	PARIS-6 GU10 CN	6x 10 W	čierna	55x165x1195

### PARIS-4-Z

materiál: hliník

GU10

220-240 V

50/60 Hz

IP 20



PARIS-4-Z GU10 CN,  
Obj. kód 325358

obj. kód	typ	max. W	farba	rozmer (mm)
325358	PARIS-4-Z GU10 CN	4x 10 W	čierna	605x1170, D55x100



TURIN GU10 IP44 CN  
Obj. kód 324696



TURIN-Z GU10 IP44 CN  
Obj. kód 324757



TURIN-N GU10 IP44 CN  
Obj. kód 324764

obj. kód	typ	max. W	farba	rozmer (mm)
324696	TURIN GU10 IP44 CN	10 W	čierna	D55x110
324764	TURIN-N GU10 IP44 CN	10 W	čierna	55x82x145
324757	TURIN-Z GU10 IP44 CN	10 W	čierna	D55x1160

## TURIN

materiál: hliník

GU10

220-240 V

50/60 Hz

IP 44



TURIN-1 GU10 IP44 CN  
Obj. kód 324702



TURIN-3 GU10 IP44 CN  
Obj. kód 324726



TURIN-2 GU10 IP44 CN  
Obj. kód 324719



TURIN-4 GU10 IP44 CN  
Obj. kód 324733



TURIN-6 GU10 IP44 CN  
Obj. kód 324740

## TURIN

materiál: hliník

GU10

220-240 V

50/60 Hz

IP 44



obj. kód	typ	max. W	farba	rozmer (mm)
324702	TURIN-1 GU10 IP44 CN	1x 10 W	čierna	D55x163
324719	TURIN-2 GU10 IP44 CN	2x 10 W	čierna	55x163x260
324726	TURIN-3 GU10 IP44 CN	3x 10 W	čierna	55x163x380
324733	TURIN-4 GU10 IP44 CN	4x 10 W	čierna	D250x163
324740	TURIN-6 GU10 IP44 CN	6x 10 W	čierna	55x163x1195



# Interiérové



TURIN GU10 IP44 BL  
Obj. kód 324771



TURIN-Z GU10 IP44 BL  
Obj. kód 324832



TURIN-N GU10 IP44 BL  
Obj. kód 324849

## TURIN

materiál: hliník

GU10

220-240 V

50/60 Hz

IP 44



obj. kód	typ	max. W	farba	rozmer (cm)
324771	TURIN GU10 IP44 BL	10 W	biela	D55x110
324849	TURIN-N GU10 IP44 BL	10 W	biela	55x82x145
324832	TURIN-Z GU10 IP44 BL	10 W	biela	D55x1160



TURIN-1 GU10 IP44 BL  
Obj. kód 324788



TURIN-2 GU10 IP44 BL  
Obj. kód 324795



TURIN-3 GU10 IP44 BL  
Obj. kód 324801

## TURIN

materiál: hliník

GU10

220-240 V

50/60 Hz

IP 44



TURIN-4 GU10 IP44 BL  
Obj. kód 324818



TURIN-6 GU10 IP44 BL  
Obj. kód 324825

obj. kód	typ	max. W	farba	rozmer (cm)
324788	TURIN-1 GU10 IP44 BL	1x 10 W	biela	D55x163
324795	TURIN-2 GU10 IP44 BL	2x 10 W	biela	55x163x260
324801	TURIN-3 GU10 IP44 BL	3x 10 W	biela	55x163x380
324818	TURIN-4 GU10 IP44 BL	4x 10 W	biela	D250x163
324825	TURIN-6 GU10 IP44 BL	6x 10 W	biela	55x163x1195



LUMO-W GU10 WHITE,  
obj. kód 2101900



LUMO-W GU10 BLACK,  
obj. kód 2101910



LUMO-C GU10 WHITE,  
obj. kód 2101920



LUMO-C GU10 BLACK,  
obj. kód 2101930

obj. kód	typ	farba	rozmer (mm)
2101900	LUMO-W GU10 WHITE	biela	D55x100
2101910	LUMO-W GU10 BLACK	čierna	D55x100
2101920	LUMO-C GU10 WHITE	biela	D55x100
2101930	LUMO-C GU10 BLACK	čierna	D55x100

## LUMO

materiál: hliník

GU10

220-240 V

50/60 Hz

IP 20



SOFIA-1 E14 CN+ME  
Obj. kód 310934



SOFIA-3 E14 CN+ME  
obj. kód 310958



SOFIA-2 E14 CN+ME  
Obj. kód 310941

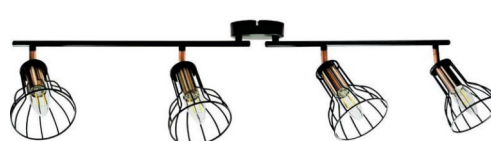

SOFIA-4 E14 CN+ME  
obj. kód 310965

## SOFIA

materiál: kov

E14

220-240 V

50/60 Hz

IP 20



obj. kód	typ	max. W	farba	rozmer (cm)
310934	SOFIA-1 E14 CN+ME	8W	čierna medená	69,5x11,2x22,2
310941	SOFIA-2 E14 CN+ME	2x 8W	čierna medená	93,5x11,2x22,2
310958	SOFIA-3 E14 CN+ME	3x 8W	čierna medená	69,5x11,2x22,2
310965	SOFIA-4 E14 CN+ME	4x 8W	čierna medená	93,5x11,2x22,2

## VIGO

materiál:  
kov

E27

220-240 V

50/60 Hz

IP 20



VIGO 1xE27 CN  
Obj. kód 314611



VIGO-O 3xE27 CN  
Obj. kód 314635



VIGO-P 3xE27 CN  
Obj. kód 314628

obj. kód	typ	max. W	farba	rozmer (mm)
314611	VIGO 1xE27 CN	20 W	čierna	D200x1200
314628	VIGO-P 3xE27 CN	3x20 W	čierna	200x600x1200
314635	VIGO-O 3xE27 CN	3x20 W	čierna	200x400x1200

## VIGO WOOD

materiál:  
kov, drevo

E27

220-240 V

50/60 Hz

IP 20



VIGO-K 1xE27 WOOD, obj. kód 314680



VIGO 3xE27 WOOD, obj. kód 314673

obj. kód	typ	max. W	farba	rozmer (mm)
314680	VIGO-K 1xE27 WOOD	20 W	čierna, drevo	200x260x380
314673	VIGO 3xE27 WOOD	3x20 W	čierna, drevo	200x750x1300



SWEDEN 1xE27 BL  
Obj. kód 306890



SWEDEN 3xE27 BL  
Obj. kód 312457



SWEDEN 1xE27 CN  
Obj. kód 305510

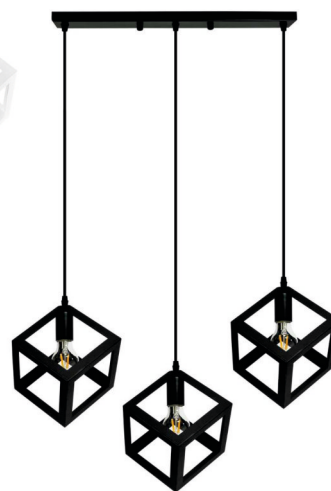

SWEDEN 3xE27 CN  
Obj. kód 310361

obj. kód	typ	max. W	farba	rozmer (mm)
306890	SWEDEN 1xE27 BL	20 W	biela	160x160x1500
312457	SWEDEN 3xE27 BL	3x 20 W	biela	250x700x1800
305510	SWEDEN 1xE27 CN	20 W	čierna	160x160x1500
310361	SWEDEN 3xE27 CN	3x 20 W	čierna	250x700x1800

## SWEDEN

materiál:  
kov

E27

220-240 V

50/60 Hz

IP 20



SWEDEN-K 1xE27 WOOD  
Obj. kód 314604

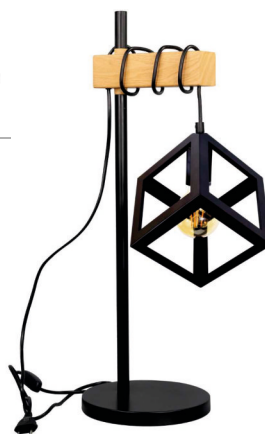

SWEDEN-L 1xE27 WOOD  
Obj. kód 314598



SWEDEN 3xE27 WOOD  
Obj. kód 314581

## SWEDEN WOOD

materiál:  
kov, drevo

E27

220-240 V

50/60 Hz

IP 20



obj. kód	typ	max. W	farba	rozmer (mm)
314604	SWEDEN-K 1xE27 WOOD	20 W	čierna, drevo	185x260x320
314581	SWEDEN 3xE27 WOOD	3x20 W	čierna, drevo	180x750x1300
314598	SWEDEN-L 1xE27 WOOD	3x20 W	čierna, drevo	185x270x600

## KLATKA

materiál: kov

E 27

220-240 V

50/60 Hz

IP 20



KLATKA-1 E27 CN-ZT  
obj. kód 312471



KLATKA-4 E27 CN-ZT  
obj. kód 312488

obj. kód	typ	max. W	farba	rozmer (mm)
312471	KLATKA-1 E27 CN-ZT	10 W	čierna, zlatá	250x250x1150
312488	KLATKA-4 E27 CN-ZT	4x 10W	čierna, zlatá	800x300x1100

## VITEZ

materiál:  
plast, PE

E27

max. 60 W

220-240 V

50/60 Hz

IP 20



VITEZ-XS WH D20CM E27  
Obj. kód 4102550



VITEZ-XM WH D28CM E27  
Obj. kód 4102580



VITEZ-XS BL D20CM E27  
Obj. kód 4102560



VITEZ-XM BL D28CM E27  
Obj. kód 4102590

obj. kód	typ	farba	rozmer (mm)
4102550	VITEZ-XS WH D20,5CM E27	biela	D205x180x650
4102580	VITEZ-XM WH D28CM E27	biela	D280x260x650
4102560	VITEZ-XS BL D20,5CM E27	čierna	D205x180x650
4102590	VITEZ-XM BL D28CM E27	čierna	D280x260x650



MODERN B-B E27 CN-ZT  
obj. kód 305459



MODERN C-B E27 CN-ZT  
obj. kód 305466



MODERN A-W E27 BL-ZT  
obj. kód: 306753



MODERN B-W E27 BL-ZT  
obj. kód: 306760



MODERN-N C-W E27 BL-ZT  
obj. kód 308009



MODERN C-W E27 BL-ZT  
obj. kód: 306777



MODERN-L C-W E27 BL-ZT  
obj. kód 308023

## MODERN

materiál: hliník

E 27

20 W

220-240 V

50/60 Hz

IP 20



obj. kód	typ	farba	rozmer (mm)
305459	MODERN B-B E27 CN-ZT	čierna, zlatá	D250 x 300 x max 1500
305466	MODERN C-B E27 CN-ZT	čierna, zlatá	D190 x 380 x max 1500
306753	MODERN A-W E27 BL-ZT	biela, zlatá	360 x 360 x max 1500
306760	MODERN B-W E27 BL-ZT	biela, zlatá	D250 x 300 x max 1500
306777	MODERN C-W E27 BL-ZT	biela, zlatá	D190 x 380 x max 1500
308009	MODERN-N C-W E27 BL-ZT	biela, zlatá	165 x 250 x 290
308023	MODERN-L C-W E27 BL-ZT	biela, zlatá	1680 x D250



## Kuchynské

### KIKI

materiál:  
plast

LED

E27

220-240 V

50/60 Hz

3000 K

IP 20



Ra >80



25000 h



KIKI LED 10W 3000K E27 CN  
obj. kód: 308085



KIKI LED 10W 3000K E27 ZN  
obj. kód: 308092



KIKI LED 10W 3000K E27 MD  
obj. kód: 308108



KIKI LED 15W 3000K E27 ZN  
obj. kód: 308139



KIKI LED 15W 3000K E27 MD  
obj. kód: 308146

obj. kód	typ	farba	W	lm	rozmer (cm)
308085	KIKI LED 10W 3000K E27 CN	čierna	10	850	D15 x 8,2 max 100
308092	KIKI LED 10W 3000K E27 ZN	zelená	10	850	D15 x 8,2 max 100
308108	KIKI LED 10W 3000K E27 MD	modrá	10	850	D15 x 8,2 max 100
308139	KIKI LED 15W 3000K E27 ZN	zelená	15	1250	D23 x 8,2 max 100
308146	KIKI LED 15W 3000K E27 MD	modrá	15	1250	D23 x 8,2 max 100

### UMEA VARBERG OTIS

materiál:  
kov, lano

E27

220-240 V

50/60 Hz

IP 20

20 W



UMEA E27 CN-HN  
obj. kód: 316523



VARBERG E27 CN-HN  
obj. kód: 316530



OTIS E27 CN-HN  
obj. kód: 316837

obj. kód	typ	farba	rozmer (cm)
316523	UMEA E27 CN-HN	bežová, čierna	D 30 x 26,5 max 120
316530	VARBERG E27 CN-HN	bežová, čierna	D 27 x 25 max 120
316837	OTIS E27 CN-HN	bežová, čierna	D 30 x 24 max 120



ROPE E27 CN-HN  
Obj. kód 321909

ROPE-PRP E27 HN  
Obj. kód 307613

ROPE PAVÚK E27 HN  
Obj. kód 312921

obj. kód	typ	farba	max. W	rozmer (mm)
321909	ROPE E27 CN-HN	bežová	12	D38 x 60 max 1500
307613	ROPE-PRP E27 HN	bežová	2x 12	100 x 100 x max 1500
312921	ROPE PAVÚK E27 HN	bežová	5x 12	1200 x 1200 x 1000

## ROPE

materiál:  
kov, lano

E27

220-240 V

50/60 Hz

IP 20

20 W



ARTHUR-N ROPE E27 HN  
obj. kód: 311450



ARTHUR-Z ROPE E27 HN  
obj. kód: 307927

## ARTHUR

materiál:  
kov, lano

E27

220-240 V

50/60 Hz

IP 20

20 W



obj. kód	typ	farba	max. W	rozmer (mm)
311450	ARTHUR-N ROPE E27 HN	bežová, čierna	12	260 x 100 x 260
307927	ARTHUR-Z ROPE E27 HN	bežová, čierna	8x 20	825 x 825 x max.1500

## BROXTON CASA GLOBO

materiál:  
kov, lano

220-240 V

50/60 Hz

IP 20



BROXTON ROPE E27 CN-HN  
Obj. kód 314529



CASA ROPE E27 CN-HN  
Obj. kód 312853



GLOBO ROPE E14 HN  
Obj. kód 307903

obj. kód	typ	pätica	farba	max. W	rozmer (mm)
314529	BROXTON ROPE E27 CN-HN	E27	hnedá, čierna	20	D250 x 265 max 1200
312853	CASA ROPE E27 CN-HN	E27	hnedá, čierna	12	300 x 300 x 1030
307903	GLOBO ROPE E14 HN	E14	bežová, čierna	3X 10	D400 X 1500

## ALEGRA ALMA AVERA

materiál:  
kov, lano

E27

220-240 V

50/60 Hz

IP 20



ALEGRA ROPE E27 CN-HN  
Obj. kód 312495



ALMA ROPE E27 CN-HN  
Obj. kód 314536



AVERA ROPE E27 CN-HN  
Obj. kód 314642

obj. kód	typ	farba	max. W	rozmer (mm)
312495	ALEGRA ROPE E27 CN-HN	bežová, čierna	4X 10	600 x 600 x max 1000
314536	ALMA ROPE E27 CN-HN	bežová, čierna	20	D310 x 370 x max 1150
314642	AVERA ROPE E27 CN-HN	bežová, čierna	20	370 x 370 x max 1150



TRAN KM9024-12W, obj. kód 62590212



TRAN KM9024-8W, obj. kód 62590208

## TRAN

materiál:  
kov, plast

LED

4000 K

85-265 V

50 Hz



IP 20

Ra>80

20000 h



obj. kód	typ	W	farba	lm	farba svetla	rozmer (mm)
62590208	TRAN KM9024-8W 4000K	8	chróm	580	neutrálina	400x135x80
62590212	TRAN KM9024-12W 4000K	12	chróm	860	neutrálina	600x135x80



SODO KM6504-14W, obj. kód 62565014

## SODO

materiál:  
kov, plast

LED

4000 K

85-265 V

50 Hz



IP 20

Ra>80

20000 h



obj. kód	typ	W	farba	lm	farba svetla	rozmer (mm)
62565014	SODO KM6504-14W 4000K	14	chróm	1000	neutrálina	500x60x110





# Kúpeľňové

## TERMA

materiál:  
kov, plast

LED

4000 K

85-265 V

50 Hz



IP 20

Ra>80



20000 h



TERMA KM6284-12W, obj. kód 62562812



TERMA KM6284-8W, obj. kód 62562808



obj. kód	typ	W	farba	lm	farba svetla	rozmer (mm)
62562808	TERMA KM6284-8W 4000K	8	chróm	580	neutrálna	500x115x60
62562812	TERMA KM6284-12W 4000K	12	chróm	860	neutrálna	600x115x60



## BALNA

materiál:  
kov, plast

LED

4000 K

85-265 V

50 Hz



IP 20

Ra>80



20000 h



BALNA KM9154-12W, obj. kód 62591512



obj. kód	typ	W	farba	lm	farba svetla	rozmer (mm)
62591512	BALNA KM9154-12W 4000K	12	chróm	860	neutrálna	525x50x150





LORELEI-8W 4000K  
Obj. kód 2110300



LORELEI-15W 4000K  
Obj. kód 2110310

## LORELEI

materiál:  
hliník, plast

LED

4000 K

220-240 V

50/60 Hz

IP 44

Ra>85

25000 h



obj. kód	typ	W	farba	lm	farba svetla	rozmer (mm)
2110300	LORELEI-8W 4000K	8	chróm	800	neutrálna	415x53x65
2110310	LORELEI-15W 4000K	15	chróm	1500	neutrálna	605x53x65



ARISTA-7W 4000K  
Obj. kód 2110320



ARISTA-15W 4000K  
Obj. kód 2110330

## ARISTA

materiál:  
plast

LED

4000 K

220-240 V

50/60 Hz

IP 44

Ra>85

25000 h



obj. kód	typ	W	farba	lm	farba svetla	rozmer (mm)
2110320	ARISTA-7W 4000K	7	biela	700	neutrálna	454x46x43
2110330	ARISTA-15W 4000K	15	biela	1500	neutrálna	604x46x43



# Kúpeľňové

## IDY

materiál:  
kov, plast

LED

4000 K

85-265 V

50 Hz



IP 20

Ra>80



20000 h



IDY KM9234-10W  
Obj. kód 62592310



IDY KM9234-8W  
Obj. kód 62592308



obj. kód	typ	W	farba	lm	farba svetla	rozmer (mm)
62592308	IDY KM9234-8W 4000K	8	chróm	580	neutrálna	460x60x110
62592310	IDY KM9234-10W 4000K	10	chróm	860	neutrálna	610x60x110



## HAMAN

materiál:  
kov, plast

LED

4000 K

85-265 V

50 Hz



IP 20

Ra>80



20000 h



HAMAN KM6194-8W  
Obj. kód 62561908



obj. kód	typ	W	farba	lm	farba svetla	rozmer (mm)
62561908	HAMAN KM6194-8W 4000K	8	chróm	580	neutrálna	550x100x50



# Kúpeľňové



ARIEL-8W 4000K CHROM  
Obj. kód 2110250



ARIEL-12W 4000K CHROM  
Obj. kód 2110270



ARIEL-8W 4000K BLACK  
Obj. kód 2110260



ARIEL-12W 4000K BLACK  
Obj. kód 2110280

obj. kód	typ	W	farba	lm	farba svetla	rozmer (mm)
2110250	ARIEL-8W 4000K CHROM	8	matný chrom	680	neutrálna	400x101x44
2110260	ARIEL-8W 4000K BLACK	8	čierna	680	neutrálna	400x101x44
2110270	ARIEL-12W 4000K CHROM	12	matný chrom	1080	neutrálna	600x101x44
2110280	ARIEL-12W 4000K BLACK	12	čierna	1080	neutrálna	600x101x44



## ARIEL

materiál:  
hliník, plast

LED

4000 K

220-240 V

50/60 Hz

IP 44

Ra>85

25000 h



ADELLA-8W 4000K CHROM  
Obj. kód 2110290

## ADELLA

materiál:  
plast

LED

4000 K

220-240 V

50/60 Hz

IP 44

Ra>85

25000 h



obj. kód	typ	W	farba	lm	farba svetla	rozmer (mm)
2110290	ADELLA-8W 4000K CHROM	8	chróm	800	neutrálna	400x109x55





# Kúpeľňové

## OVALINE

materiál:  
hliník, plast

LED

4000 K

220-240 V

50/60 Hz

IP 44

Ra>80

30000 h



OVALINE 7W 4000K IP44  
Obj. kód 3310670



OVALINE 14W 4000K IP44  
Obj. kód 3310680

obj. kód	typ	W	farba	lm	farba svetla	rozmer (mm)
3310670	OVALINE 7W 4000K IP44	7	strieborná	665	neutrálina	280x37,5x55
3310680	OVALINE 14W 4000K IP44	14	strieborná	1400	neutrálina	540x37,5x55



## KAPO

materiál:  
kov, plast

LED

4000 K

85-265 V

50 Hz

IP 20

Ra>80

20000 h



KM7034-8W 4000K  
Obj. kód 62570308



KM7034-12W 4000K  
Obj. kód 62570312

obj. kód	typ	W	farba	lm	farba svetla	rozmer (mm)
62570308	KM7034-8W 4000K	8	chróm, strieborná	580	neutrálina	500x230x50
62570312	KM7034-12W 4000K	12	chróm, strieborná	780	neutrálina	600x230x50





LEDBULL

## LEDBULL

materiál: kov

LED

IP 20

35000 h

Ra>80



obj. kód	typ	W	U	Hz	lm	farba	rozmer (mm)
2110190	LEDBULL-5W 3000K	5	110-240 V	50	275	chróm	400x55x85
2110191	LEDBULL-5W 6000K	5	110-240 V	50	300	chróm	400x55x85
2110210	LEDBULL-D 6W 3000K	6	100-240 V	50/60	450	chróm	400x180x55
2110220	LEDBULL-D 6W 6000K	6	100-240 V	50/60	480	chróm	400x180x55



BAGNO  
Obj. kód 2110230

## BAGNO

materiál:  
kov, plast

LED

8 W

110-240 V

50 Hz



IP 20



35000 h



Ra>80

obj. kód	typ	lm	farba	rozmer (mm)
2110230	BAGNO-8W 3000K	600	chróm	410x90





# Kúpeľňové

## PETRA

materiál:  
plast, sklo

E27

60 W

230 V

50 Hz



IP 44



max.  
1200 W  
(senzor 910001)



2-2000 lux  
(senzor 910001)



910001 - s mikrovlnným senzorom  
Obj. kód 60910001



910010 - bez senzora  
Obj. kód 60910010

obj. kód	typ	farba	senzor	rozmer (mm)
60910001	910001 PETRA	biela	áno - mikrovlnný	D275x90
60910010	910010 PETRA	biela	nie	D275x90

## KAROLINA

materiál:  
plast, sklo

E27

2x 60 W

230 V

50 Hz

IP 44



908070 KAROLINA  
Obj. kód 60908070



obj. kód	typ	farba	rozmer (mm)
60908070	908070 KAROLINA	biela	D400x120



30L  
Obj. kód 5020090

**30L**

materiál:  
plast

**LED**

**2 W**

**220-240 V**

**50/60 Hz**

3,7V Li 18650  
(3h)

**IP 20**



**6400 K**



**50000 h**

**Ra>80**



obj. kód	typ	lm	batéria	výdrž	farba	rozmer (mm)
5020090	30L - núdzové	130/60	Li 18650, 3,7V	3 h	biela	55x28x205





# Núdzové

## EXIT-12

materiál:  
plast

LED

2 W

100-240 V

50/60 Hz

IP 65



6500 K



Ra>80

50000 h



EXIT-12  
Obj. kód 5020100

obj. kód	typ	lm	doba nabíjania	čas svietenia	farba	rozmer (mm)
5020100	EXIT-12	160	24 h	3 h	biela	275x108x40

## EXIT-60

materiál:  
plast

LED

4 W

100-240 V

50/60 Hz

IP 20



6500 K



Ra>80

50000 h



EXIT-60  
Obj. kód 5020120

obj. kód	typ	lm	doba nabíjania	čas svietenia	farba	rozmer (mm)
5020120	EXIT-60	320/160	24 h	3 h	biela	342x55x30



EXIT-10  
Obj. kód 5020140



EXIT-10 SIDE  
Obj. kód 5020150



EXIT-10 DOWN  
Obj. kód 5020160

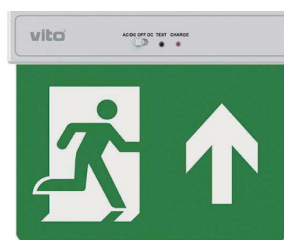

EXIT-10 UP  
Obj. kód 5020170

## EXIT-10

materiál:  
plast

LED

2 W

100-240 V

50/60 Hz

3,7V 0,5A  
Li-ion 14500

IP 20



6500 K



50000 h

Ra>80

obj. kód	typ	lm	doba nabíjania	čas svietenia	farba	rozmer (mm)
5020140	EXIT-10	100	12-15 h	10 h	biela, zelená	255x210x23
5020150	EXIT-10 SIDE	100	12-15 h	10 h	biela, zelená	255x210x23
5020160	EXIT-10 DOWN	100	12-15 h	10 h	biela, zelená	255x210x23
5020170	EXIT-10 UP	100	12-15 h	10 h	biela, zelená	255x210x23



KIT 3-50W 3H 3,7V 2,2AH  
Obj. kód 6200150



KIT 10-50W 3H 3X3,7V 2,2AH  
Obj. kód 6200160

## KIT

materiál:  
plast

100-240 V

50/60 Hz

IP 20



50000 h



obj. kód	typ	W	doba nabíjania	čas prevádzky	farba	rozmer (mm)
6200150	KIT 3-50W 3H 3,7V 2,2AH	3-50 W	24 h	3 h	biela	150x40x28
6200160	KIT 10-50W 3H 3X3,7V 2,2AH	10-50 W	24 h	3 h	biela	150x40x28



LIGURIA-N1 E27 CN  
Obj. kód 201928



LIGURIA-N2 E27 CN  
Obj. kód 201935



LIGURIA-S42 E27 CN  
Obj. kód 201942



LIGURIA-N1 E27 PT  
Obj. kód 201959



LIGURIA-N2 E27 PT  
Obj. kód 201966



LIGURIA-S42 E27 PT  
Obj. kód 201973



LIGURIA-S96 E27 CN  
Obj. kód 202185



LIGURIA-Z E27 CN  
Obj. kód 202161



LIGURIA-Z E27 PT  
Obj. kód 202178



LIGURIA-S96 E27 PT  
Obj. kód 202253

## LIGURIA

materiál:  
kov, sklo

E27

max. 20 W

220-240V

50/60 Hz

IP 43



obj. kód	typ	farba	rozmer(mm)
201928	LIGURIA-N1 E27 CN	čierna	370x205x150
201935	LIGURIA-N2 E27 CN	čierna	370x205x150
201942	LIGURIA-S42 E27 CN	čierna	D150x170x425
201959	LIGURIA-N1 E27 PT	platina	370x205x150
201966	LIGURIA-N2 E27 PT	platina	370x205x150
201973	LIGURIA-S42 E27 PT	platina	D150x170x425
202161	LIGURIA-Z E27 CN	čierna	D150x920
202178	LIGURIA-Z E27 PT	platina	D150x920
202185	LIGURIA-S96 E27 CN	čierna	D150x175x965
202253	LIGURIA-S96 E27 PT	platina	D150x175x965

# Exteriérové



IGMA-Z E27 CN  
Obj. kód 311887



IGMA-N E27 CN  
Obj. kód 311870



IGMA-S29 E27 CN  
Obj. kód 311894



IGMA-S86 E27 CN  
Obj. kód 311900

obj. kód	typ	max. W	farba	rozmer (mm)
311887	IGMA-Z E27 CN	12	čierna	155x155x780
311870	IGMA-N E27 CN	12	čierna	155x195x235
311894	IGMA-S29 E27 CN	12	čierna	155x155x295
311900	IGMA-S86 E27 CN	12	čierna	155x155x860

## IGMA

materiál:  
kov, plast

E27

220-240 V

50/60 Hz

IP 44



NEW YORK-N E27 GRAFIT  
Obj. kód 304612



NEW YORK-S44 E27 GRAFIT  
Obj. kód 304629



NEW YORK-S44-S E27 GRAFIT  
Obj. kód 307330

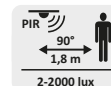

2-2000 lux  
10s. - 4 min.



NEW YORK-S74 E27 GRAFIT  
Obj. kód 304636



NEW YORK-S44-Z E27 GRAFIT  
Obj. kód 307323

obj. kód	typ	max. W	farba	rozmer (mm)
304612	NEW YORK-N E27 GRAFIT	12	grafit	160x78x110
304629	NEW YORK-S44 E27 GRAFIT	12	grafit	78x78x110x110x440
304636	NEW YORK-S74 E27 GRAFIT	12	grafit	78x78x110x110x740
307323	NEW YORK-S44-Z E27 GRAFIT	12	grafit	78x78x110x110x440
307330	NEW YORK-S44-S E27 GRAFIT	12	grafit	78x78x110x110x440

## NEW YORK

materiál:  
kov, plast

E27

220-240 V

50/60 Hz

IP 44



## TEKSAS

materiál:  
kov, plast

E27

220-240 V

50/60 Hz

IP 44



TEKSAS-S44 E27 GRAFIT  
Obj. kód 316172



TEKSAS-N E27 GRAFIT  
Obj. kód 316165



TEKSAS-S74 E27 GRAFIT  
Obj. kód 316189

obj. kód	typ	max. W	farba	rozmer (mm)
316165	TEKSAS-N E27 GRAFIT	12	grafit	200x90x120
316172	TEKSAS-S44 E27 GRAFIT	12	grafit	90x90x130x130x440
316189	TEKSAS-S74 E27 GRAFIT	12	grafit	90x90x130x130x740

## TEKSAS-S

materiál:  
kov, plast

E27

220-240 V

50/60 Hz

IP 44

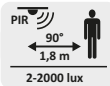

10s. -4 min.



TEKSAS-S44-S E27 GRAFIT  
Obj. kód 317933



TEKSAS-N-S E27 GRAFIT  
Obj. kód 317667



TEKSAS-S74-S E27 GRAFIT  
Obj. kód 317650

obj. kód	typ	max. W	farba	rozmer (mm)
317667	TEKSAS-N-S E27 GRAFIT	12	grafit	200x90x120
317933	TEKSAS-S44-S E27 GRAFIT	12	grafit	90x90x130x130x440
317650	TEKSAS-S74-S E27 GRAFIT	12	grafit	90x90x130x130x740

# Exteriérové



DALLAS-N E27 GRAFIT  
Obj. kód 315960



DALLAS-S44 E27 GRAFIT  
Obj. kód 315977



DALLAS-S44-S E27 GRAFIT  
Obj. kód 316004

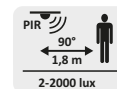

10s. - 4 min.



DALLAS-S60 E27 GRAFIT  
Obj. kód 315984



DALLAS-S44-Z E27 GRAFIT  
Obj. kód 315991

obj. kód	typ	max. W	farba	rozmer (mm)
315960	DALLAS-N E27 GRAFIT	12	grafit	170x78x95
315977	DALLAS-S44 E27 GRAFIT	12	grafit	D80x110x440
315984	DALLAS-S60 E27 GRAFIT	12	grafit	D80x110x600
315991	DALLAS-S44-Z E27 GRAFIT	12	grafit	D80x110x440
316004	DALLAS-S44-S E27 GRAFIT	12	grafit	D80x110x440

## DALLAS

materiál:  
kov, plast

E27

220-240 V

50/60 Hz

IP 44



RIGA B50  
Obj. kód 3241420



RIGA W1  
Obj. kód 3241400



RIGA B90  
Obj. kód 3231430



RIGA W1S  
Obj. kód 3241410

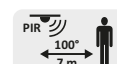

## RIGA

materiál:  
kov, sklo

GU10

220-240 V

50/60 Hz

IP 44



obj. kód	typ	W	senzor	farba	rozmer (mm)
3241400	RIGA W1	7 W	nie	grafit	108x220
3241410	RIGA W1S	7 W	áno - pohybový	grafit	116x290
3241420	RIGA B50	7 W	nie	grafit	D98x500
3231430	RIGA B90	7 W	nie	grafit	D98x900



## Exteriérové

### KOTOR

materiál:  
hliník, sklo

E27

220-240 V

50/60 Hz

IP 44



KOTOR W1  
Obj. kód 3230350

obj. kód	typ	W	farba	rozmer (mm)
3230350	KOTOR W1	60 W	grafit	116x250

### MULIER

materiál:  
hliník, sklo

GU10

220-240 V

50/60 Hz

IP 44



MULIER  
Obj. kód 3230300



obj. kód	typ	W	farba	rozmer (mm)
3230300	MULIER	2x35 W	grafit	87x148



VEGAS-A NCK  
Obj. kód 3240540



VEGAS-2A NCK  
Obj. kód 3240550

## VEGAS

materiál:  
kov, sklo

GU10

230 V

50 Hz

IP 44



obj. kód	typ	W	farba	rozmer (mm)
3240540	VEGAS-A NCK	35 W	nikel	60x96x116
3240550	VEGAS-2A NCK	2x35 W	nikel	60x96x160



BOSTON 1XGU10 BL  
Obj. kód 313379



BOSTON 1XGU10 CN  
Obj. kód 303318



BOSTON 1XGU10 GR  
Obj. kód 313331



BOSTON 1XGU10 ST  
Obj. kód 304568



BOSTON 2XGU10 BL  
Obj. kód 313362



BOSTON 2XGU10 CN  
Obj. kód 303332



BOSTON 2XGU10 GR  
Obj. kód 313324

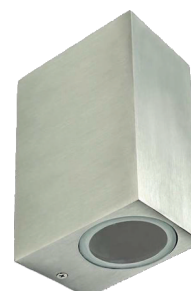

BOSTON 2XGU10 ST  
Obj. kód 304582

## BOSTON

materiál:  
hliník, sklo

GU10

220-240 V

50/60 Hz

IP 44



obj. kód	typ	W	farba	rozmer (mm)
313379	BOSTON 1XGU10 BL	10 W	biela	67x92x80
303318	BOSTON 1XGU10 CN	10 W	čierna	67x92x80
313331	BOSTON 1XGU10 GR	10 W	grafit	67x92x80
304568	BOSTON 1XGU10 ST	10 W	satina	67x92x80
313362	BOSTON 2XGU10 BL	2x10 W	biela	67x92x150
303332	BOSTON 2XGU10 CN	2x10 W	čierna	67x92x150
313324	BOSTON 2XGU10 GR	2x10 W	grafit	67x92x150
304582	BOSTON 2XGU10 ST	2x10 W	satina	67x92x150



## Exteriérové



VEGAS P1  
Obj. kód 3230310



VEGAS P2  
Obj. kód 3230320



### VEGAS

materiál: plast

GU10

220-240 V

50/60 Hz

IP 44



obj. kód	typ	W	farba	rozmer (mm)
3230310	VEGAS-P1	7 W	grafit	80x120
3230320	VEGAS-P2	2x7 W	grafit	80x160

### MORRIS

materiál:  
kov

GU10

220-240 V

50/60 Hz

IP 54



MORRIS GU10 CN  
Obj. kód 323255

obj. kód	typ	max. W	farba	rozmer (mm)
323255	MORRIS GU10 CN	12	čierna	87 x 87 x 92

# Exteriérové



SPIDER-1D NCK  
Obj. kód 3230040



SPIDER-1D GRY  
Obj. kód 3230030



SPIDER-1D WH  
Obj. kód 3230430



SPIDER-2D NCK  
Obj. kód 3230060



SPIDER-2D GRY  
Obj. kód 3230050



SPIDER-2D WH  
Obj. kód 3230440

## SPIDER

materiál:  
kov, sklo

GU10

220-240 V

50 Hz

IP 44



obj. kód	typ	W	farba	rozmer (mm)
3230030	SPIDER-1D GRY	35 W	grafit	67x86x80
3230040	SPIDER-1D NCK	35 W	nikel	67x86x80
3230430	SPIDER-1D WH	35 W	biela	67x86x80
3230050	SPIDER-2D GRY	2x35 W	grafit	67x86x145
3230060	SPIDER-2D NCK	2x35 W	nikel	67x86x145
3230440	SPIDER-2D WH	2x35 W	biela	67x86x145



BINO-1 2W IP65 CCT BLACK  
Obj. kód 3231070



BINO-1 2W IP65 CCT WHITE  
Obj. kód 3231080



BINO-2 4W IP65 CCT BLACK  
Obj. kód 3231090



BINO-2 4W IP65 CCT WHITE  
Obj. kód 3231100



BINO-3 6W IP65 CCT BLACK  
Obj. kód 3231110

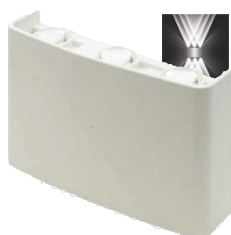

BINO-3 6W IP65 CCT WHITE  
Obj. kód 3231120

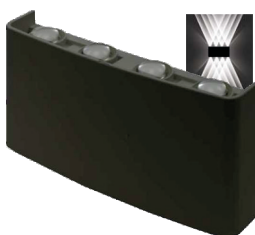

BINO-4 8W IP65 CCT BLACK  
Obj. kód 3231130



BINO-4 8W IP65 CCT WHITE  
Obj. kód 3231140

## BINO

materiál:  
kov, plast

LED

220-240 V

50/60 Hz

3 CCT  
DIP SWITCH  
SELCTABLE  
3000-6000 K

IP 65

30000 h

Ra>80



obj. kód	typ	W	lm	farba	rozmer (mm)
3231070	BINO-1 2W IP65 CCT BLACK	2	180	čierna	110x100x40
3231080	BINO-1 2W IP65 CCT WHITE	2	180	biela	110x100x40
3231090	BINO-2 4W IP65 CCT BLACK	4	360	čierna	110x100x40
3231100	BINO-2 4W IP65 CCT WHITE	4	360	biela	110x100x40
3231110	BINO-3 6W IP65 CCT BLACK	6	540	čierna	160x100x40
3231120	BINO-3 6W IP65 CCT WHITE	6	540	biela	160x100x40
3231130	BINO-4 8W IP65 CCT BLACK	8	720	čierna	210x100x40
3231140	BINO-4 8W IP65 CCT WHITE	8	720	biela	210x100x40





ADRIA-S1 GU10 IP54  
Obj. kód 3230530



ADRIA-S2 GU10 IP54  
Obj. kód 3230540



ADRIA-S2 E27 IP54  
Obj. kód 3230550

## ADRIA-S

materiál: plast

220-240 V

50/60 Hz

IP 54



obj. kód	typ	pätica	max. W	farba	rozmer (mm)
3230530	ADRIA-S1 GU10 IP54	GU10	8,5	antracit	D72x140
3230540	ADRIA-S2 GU10 IP54	GU10	8,5	antracit	D90x140
3230550	ADRIA-S2 E27 IP54	E27	150	antracit	D120x170



ADRIA-SQ1 Gu10 ANTRACIT  
Obj. kód 3230590



ADRIA-R1 GU10 ANTRACIT  
Obj. kód 3230600



ADRIA-SQ2 2xGU10 ANTRACIT  
Obj. kód 3230610



ADRIA-R2 2xGU10 ANTRACIT  
Obj. kód 3230620

## ADRIA-R ADRIA-SQ

materiál: plast

GU10

220-240 V

50/60 Hz

IP 54



obj. kód	typ	max. W	farba	rozmer (mm)
3230590	ADRIA-SQ1 GU10 ANTRACIT	8,5	antracit	76x148x99
3230600	ADRIA-R1 GU10 ANTRACIT	8,5	antracit	76x148x99
3230610	ADRIA-SQ2 2XGU10 ANTRACIT	2x 8,5	antracit	76x186x99
3230620	ADRIA-R2 2XGU10 ANTRACIT	2x 8,5	antracit	76x186x99



ADRIA-SQC1 GU10 ANTRACIT  
Obj. kód 3230510



ADRIA-SQC2 2XGU10 ANTRACIT  
Obj. kód 3230520

## ADRIA-SQC

materiál: plast

GU10

220-240 V

50/60 Hz

IP 54



obj. kód	typ	max. W	farba	rozmer (mm)
3230510	ADRIA-SQC1 GU10 ANTRACIT	8,5	antracit	70x90x92
3230520	ADRIA-SQC2 2XGU10 ANTRACIT	2x 8,5	antracit	70x160x92



ADRIA-WL2 10W 4000K IP65  
Obj. kód 3230470



ADRIA-W1 6W 4000K IP65  
Obj. kód 3230480



ADRIA-UD1 12W 4000K IP65  
Obj. kód 3230500



ADRIA-UD2 8W 4000K IP65  
Obj. kód 3230560

## ADRIA-W

## ADRIA-UD

materiál: plast

LED

50/60 Hz

IP 65

4000 K

30000 h

Ra>80



obj. kód	typ	W	U	lm	farba	uhol	rozmer (mm)
3230470	ADRIA-WL2 10W 4000K IP65	10	100-240V	650	antracit	2x120°	170x80x46
3230480	ADRIA-W1 6W 4000K IP65	6	220-240V	360	antracit	90°	220x113x51
3230500	ADRIA-UD1 12W 4000K IP65	12	220-240V	780	antracit	2x60°	200x125x39
3230560	ADRIA-UD2 8W 4000K IP65	8	220-240V	360	antracit	2x90°	120x200





## Exteriérové

### ADRIA-ST

materiál: plast

LED

220-240 V

50/60 Hz

IP 65

4000 K

Ra>80

30000 h



ADRIA-ST1G 6W 4000K IP65  
Obj. kód 3230630



ADRIA-ST1P 6W 4000K IP65  
Obj. kód 3230640



ADRIA-ST2 2W 4000K IP65  
Obj. kód 3230450



ADRIA-ST2G 6W 4000K IP65  
Obj. kód 3230660



ADRIA-ST2P 6W 4000K IP65  
Obj. kód 3230650

obj. kód	typ	W	lm	uhol	farba	rozmer (mm)
3230630	ADRIA-ST1G 6W 4000K IP65	6	180	45°	antracit	255x90x42
3230640	ADRIA-ST1P 6W 4000K IP65	6	150	90°	antracit	255x90x42
3230450	ADRIA-ST2 2W 4000K IP65	2	90	60°	antracit	100x60
3230650	ADRIA-ST2P 6W 4000K IP65	6	270	90°	antracit	135x135x52
3230660	ADRIA-ST2G 6W 4000K IP65	6	150	60°	antracit	135x135x52



VALENCIA E27 IP44 NICKEL  
Obj. kód 3231040



VALENCIA E27 IP44 WHITE  
Obj. kód 3231050

### VALENCIA

materiál:  
plast, kov

E27

180-265 V

50/60 Hz

IP 44



VALENCIA E27 IP44 BLACK  
Obj. kód 3231060

obj. kód	typ	farba	rozmer (mm)
3231040	VALENCIA E27 IP44 NICKEL	nikel	315x90x100
3231050	VALENCIA E27 IP44 WHITE	biela	315x90x100
3231060	VALENCIA E27 IP44 BLACK	čierna	315x90x100



SAFON-HN E27 IP44  
Obj. kód 209276

obj. kód	typ	max. W	farba	rozmer (mm)
209276	SAFON-HN E27 IP44	14	hnedá	205 x 95 x 275

## SAFON

materiál:  
kov, plast

E27

220-240 V

50/60 Hz

IP 44



RONO E27 MCH  
Obj. kód 309792

obj. kód	typ	max. W	farba	rozmer (mm)
309792	RONO E27 MCH	14	matný chróm	100x308

## RONO

materiál:  
kov, plast

E27

220-240 V

50/60 Hz

IP 44





# Exteriérové

## TESA-Q

materiál:  
plast

LED

220-240 V

50/60 Hz

4000 K

Ra>80

IP 54

25000 h



TESA-Q 10W LED 4000K CN  
Obj. kód 324047

obj. kód	typ	W	lm	farba	rozmer (mm)
324047	TESA-Q 10W LED 4000K CN	10	1100	čierna	210x90x82



## TONY-N

materiál:  
plast

LED

5 V

IP 44

10000 h

6500 K

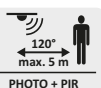

TONY-N LED 6500K CN  
Obj. kód 325464

obj. kód	typ	lm	doba nabíjania	čas svietenia	farba	rozmer (mm)
325464	TONY-N LED 6500K CN	200-600	8-10 h	max. 5h	čierna	210x122x90



SOLUX-P 1W 6000K  
Obj. kód 3210320



SOLUX-S 1W 6000K  
Obj. kód 3210330

obj. kód	typ	U	lm	farba	rozmer (mm)
3210320	SOLUX-P 1W 6000K	2V DC	50	čierna	D121,5x366,5
3210330	SOLUX-S 1W 6000K	5V DC	150	čierna	117,5x89x290

## SOLUX-P SOLUX-S

materiál:  
plast

LED

1 W

6000 K

IP 44

30000 h

Ra>80



SOLIGHT-P 4W 6400K  
Obj. kód 3210150



SOLIGHT-F 3W 6400K  
Obj. kód 3210190

obj. kód	typ	W	lm	farba	rozmer (mm)
3210190	SOLIGHT-F 3W 6400K	3	440	čierna	210x110
3210150	SOLIGHT-P 4W 6400K	4	550	čierna	168x174x87

## SOLIGHT-F SOLIGHT-P

materiál: plast

LED

5,5 V

IP 44

30000 h

6400 K

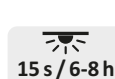



# Exteriérové

## SOLIGHT-T SOLIGHT-V SOLIGHT-W

materiál: plast

LED

5,5 V

IP 44

30000 h

6400 K



6 h

15 s / 6-8 h



SOLIGHT-T 1W 6400K  
Obj. kód 3210170



SOLIGHT-V 3W 6400K  
Obj. kód 3210160



SOLIGHT-W 1W 6400K  
Obj. kód 3210180

obj. kód	typ	W	lm	°	farba	rozmer (mm)
3210170	SOLIGHT-T 1W 6400K	1	170	180°	čierna	138x97
3210160	SOLIGHT-V 3W 6400K	3	170	120°	čierna	168x114
3210180	SOLIGHT-W 1W 6400K	1	110	180°	čierna	124x96

## SOLUX-W

materiál:  
plast

LED

2 W

5,5V DC

6000 K

IP 44



30000 h



Ra>80



LiFePo4 3,7V/1,8Ah  
18650



SOLUX-W 2W 6000K  
Obj. kód 3210340

obj. kód	typ	lm	farba	rozmer (mm)
3210340	SOLUX-W 2W 6000K	450	čierna	143x90x114,5 / 143x52x11



LUCE-CN  
Obj. kód 323118

obj. kód	typ	lm	farba	rozmer (mm)
323118	LUCE-CN 6000K IP44	10	čierna	74x31x97

## LUCE

materiál:  
ABS, PC

LED

6000 K

IP 44



30000 h



Ra>80



KALAHARI-2W 3000-6000K  
Obj. kód 3210280

obj. kód	typ	lm	farba	rozmer (mm)
3210280	KALAHARI-2W 3000-6000K	100	čierna	150x150x126

## KALAHARI

materiál:  
plast

LED

2 W

5V DC

CCT  
3000-6400K

IP 65



30000 h



Ra>80





## Exteriérové

### TINO

materiál:  
hliník, plast

LED

2 W

220-240 V

110 lm

25000 h

50/60 Hz



IP 65



Ra>80



TINO-R 2W 3000K IP65 BLACK, obj. kód 3410340  
TINO-R 2W 4000K IP65 BLACK, obj. kód 3410350



TINO-R 2W 3000K IP65 WHITE, obj. kód 3410360  
TINO-R 2W 4000K IP65 WHITE, obj. kód 3410370



TINO-S 2W 3000K IP65 BLACK, obj. kód 3410280  
TINO-S 2W 4000K IP65 BLACK, obj. kód 3410390



TINO-S 2W 3000K IP65 WHITE, obj. kód 3410400  
TINO-S 2W 4000K IP65 WHITE, obj. kód 3410410

obj. kód	typ	farba	farba svetla	rozmer (mm)
3410340	TINO-R 2W 3000K IP65 BLACK	čierna	teplá	D48x61,5
3410350	TINO-R 2W 4000K IP65 BLACK	čierna	neutrálna	D48x61,5
3410360	TINO-R 2W 3000K IP65 WHITE	biela	teplá	D48x61,5
3410370	TINO-R 2W 4000K IP65 WHITE	biela	neutrálna	D48x61,5
3410380	TINO-S 2W 3000K IP65 BLACK	čierna	teplá	48x48x61,5
3410390	TINO-S 2W 4000K IP65 BLACK	čierna	neutrálna	48x48x61,5
3410400	TINO-S 2W 3000K IP65 WHITE	biela	teplá	48x48x61,5
3410410	TINO-S 2W 4000K IP65 WHITE	biela	neutrálna	48x48x61,5



### GRANDE

materiál:  
kov, sklo

GU10

max. 50 W

220-240 V

50/60 Hz

IP 67



GRANDE-B12R GU10  
Obj. kód 3200180



obj. kód	typ	farba	rozmer (mm)
3200180	GRANDE-B12R GU10	nikel	D110x148



CUBO E27 IP44 BLACK  
Obj. kód 3242260

## CUBO

materiál: plast

E27

max. 15 W

220-240 V

50/60 Hz

IP 44



obj. kód	typ	farba	rozmer (mm)
3242260	CUBO E27 IP44 BLACK	čierna	225x225x280

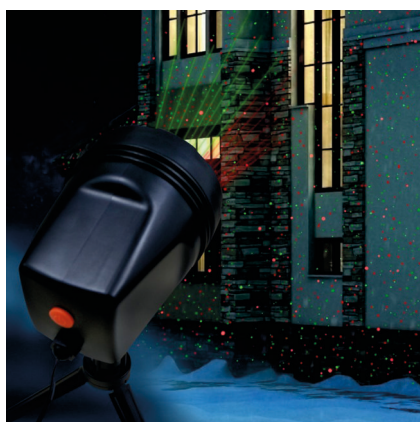
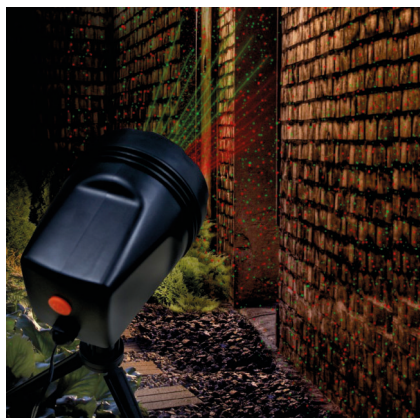

TOP-A1A 5W IP44  
Obj. kód 308948



TOP-A3 5W IP44  
Obj. kód 309068

## TOP-A

materiál: plast

LASER

5 W

100-240V

50/60 Hz

IP 44



obj. kód	typ	farba	farba svetla	rozmer (mm)
308948	TOP-A1A 5W IP44	čierna	zelená, červená	129x265x96
309068	TOP-A3 5W IP44	čierna	zelená, červená	129x265x96



## Exteriérové

### LAGOS

materiál:  
kov, plast

GU10

220-240 V

50 Hz

IP 65



obj. kód	typ	W	farba	rozmer (mm)
3240510	LAGOS GU10-35W	35 W	čierna	D90x315,5

### PRATUM

materiál: plast

GU10

max. 8,5 W

220-240 V

50/60 Hz

IP 65



PRATUM GU10 IP65 BLACK  
Obj. kód 3241620

obj. kód	typ	farba	rozmer (mm)
3241620	PRATUM GU10 IP65 BLACK	čierna	D60x346

# Exteriérové



STRING 10M  
Obj. kód 7300170



STRING 15M  
Obj. kód 7300180

## GIRLANDA

materiál:  
plast

E27

10x/15x  
max. 60 W

220-240 V

50/60 Hz

IP 44



obj. kód	typ	W	dĺžka (m)
7300170	STRING 10M	10x max. 60 W	10
7300180	STRING 15M	15x max. 60 W	15



SPARKY-5W 1600K FLAME  
Obj. kód 5010280

## SPARKY

materiál: plast

LED

CRI 50

5 W

5V DC



360°

20 lm



1600K



3,7 V Li 18650

IP 54



3-4 h

30000 h



max. 30 h



obj. kód	typ	farba	farba svetla	rozmer (mm)
5010280	SPARKY-5W 1600K FLAME	zelená	imitácia plameňa	D120x154/242

## ATAKAMA

materiál:  
kov, sklo, plast

LED

CCT  
3000-6400K

IP 65

30000 h

Ra>80

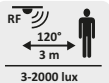

ATAKAMA-10W 3XCCT  
Obj. kód 3022500



ATAKAMA-20W 3XCCT  
Obj. kód 3022510

obj. kód	typ	W	U	lm	farba	rozmer (mm)
3022500	ATAKAMA-10W 3XCCT	10	5V DC	250, 500, 1000	čierna	143x97x44.5
3022510	ATAKAMA-20W 3XCCT	20	5,5V DC	300, 600, 1200	čierna	194x97x44.5

## SAHARA

materiál:  
kov, sklo, plast

LED

5V DC

6000 K

IP 65

30000 h



Ra>80



SAHARA-100W 6000K  
Obj. kód 3210200



SAHARA-150W 6000K  
Obj. kód 3210210



SAHARA-250W 6000K  
Obj. kód 3210220



SAHARA-300W 6000K  
Obj. kód 3210230

obj. kód	typ	W	lm	farba	rozmer (mm) telo/panel
3210200	SAHARA-100W 6000K	100	1100	čierna	198x193x48 / 205x300x17
3210210	SAHARA-150W 6000K	150	1650	čierna	248,5x233x48 / 390x230x17
3210220	SAHARA-250W 6000K	250	2750	čierna	283x260x48 / 390x300x17
3210230	SAHARA-300W 6000K	300	3300	čierna	318x288x48 / 390x360x17

# Exteriérové



SAVA 10W 4000K, obj. kód 3022520  
SAVA 10W 6000K, obj. kód 3022530



SAVA 20W 4000K, obj. kód 3022550  
SAVA 20W 6000K, obj. kód 3022560



SAVA 30W 4000K, obj. kód 3022580  
SAVA 30W 6000K, obj. kód 3022590



SAVA 50W 4000K, obj. kód 3022600  
SAVA 50W 6000K, obj. kód 3022610



SAVA 100W 4000K, obj. kód 3022620  
SAVA 100W 6000K, obj. kód 3022630



SAVA 150W 6000K  
Obj. kód 3022650



SAVA 200W 6000K  
Obj. kód 3022670



SAVA 300W 6000K  
Obj. kód 3022690

obj. kód	typ	W	lm	farba	farba svetla	rozmer (mm)
3022520	SAVA 10W 4000K	10	980	čierna	neutrálna	101,3x97,9x25,9
3022530	SAVA 10W 6000K	10	1000	čierna	studená	101,3x97,9x25,9
3022550	SAVA 20W 4000K	20	1960	čierna	neutrálna	119,9x112,3x27,5
3022560	SAVA 20W 6000K	20	2000	čierna	studená	119,9x112,3x27,5
3022580	SAVA 30W 4000K	30	2940	čierna	neutrálna	155,9x140,7x29,8
3022590	SAVA 30W 6000K	30	3000	čierna	studená	155,9x140,7x29,8
3022600	SAVA 50W 4000K	50	4900	čierna	neutrálna	187,9x170x1x31,8
3022610	SAVA 50W 6000K	50	5000	čierna	studená	187,9x170x1x31,8
3022620	SAVA 100W 4000K	100	9800	čierna	neutrálna	187,9x170x1x31,8
3022630	SAVA 100W 6000K	100	10000	čierna	studená	187,9x170x1x31,8
3022650	SAVA 150W 6000K	150	15000	čierna	studená	297,4x230x35,4
3022670	SAVA 200W 6000K	200	20000	čierna	studená	328,8x274,9x37,4
3022690	SAVA 300W 6000K	300	30000	čierna	studená	378,9x312,5x45,2



## SAVA

materiál:  
hliník, sklo

LED

185-265 V

50/60 Hz

IP 65

30000 h



SAVA-S 10W 6000K  
Obj. kód 3022700



SAVA-S 20W 6000K  
Obj. kód 3022710



SAVA-S 30W 6000K  
Obj. kód 3022720



SAVA-S 50W 6000K  
Obj. kód 3022730



## SAVA-S

materiál:  
hliník, sklo

LED

185-265 V

50/60 Hz

6000 K

IP 65

30000 h

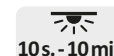
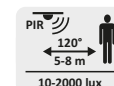

obj. kód	typ	W	lm	farba	rozmer (mm)
3022700	SAVA-S 10W 6000K	10	1000	čierna	104,8x134,6x52,8
3022710	SAVA-S 20W 6000K	20	2000	čierna	123,5x148,7x54,1
3022720	SAVA-S 30W 6000K	30	3000	čierna	159x178x55,9
3022730	SAVA-S 50W 6000K	50	5000	čierna	192,8x203,9x57,4





## Exteriérové



### RONA

materiál:  
hliník, sklo

LED

185-265 V

50/60 Hz

IP 65

30000 h



RONA 30W 4000K, obj. kód 3022740  
RONA 30W 6000K, obj. kód 3022750



RONA 50W 4000K, obj. kód 3022760  
RONA 50W 6000K, obj. kód 3022770



RONA 100W 4000K, obj. kód 3022780  
RONA 100W 6000K, obj. kód 3022790



RONA 150W 6000K  
Obj. kód 3022800



RONA 200W 6000K  
Obj. kód 3022810



RONA 300W 6000K  
Obj. kód 3022820



RONA 400W 6000K  
Obj. kód 3022830

obj. kód	typ	W	lm	farba	farba svetla	rozmer (mm)
3022740	RONA 30W 4000K	30	3540	šedá	neutrálna	160x138,7x26
3022750	RONA 30W 6000K	30	3600	šedá	studená	160x138,7x26
3022760	RONA 50W 4000K	50	5900	šedá	neutrálna	191x165x27
3022770	RONA 50W 6000K	50	6000	šedá	studená	191x165x27
3022780	RONA 100W 4000K	100	11800	šedá	neutrálna	236x203x26
3022790	RONA 100W 6000K	100	12000	šedá	studená	236x203x26
3022800	RONA 150W 6000K	150	18000	šedá	studená	276x231x30
3022810	RONA 200W 6000K	200	24000	šedá	studená	312x266x31
3022820	RONA 300W 6000K	300	36000	šedá	studená	396x321x41
3022830	RONA 400W 6000K	400	48000	šedá	studená	494x400x31



UNI 165CM  
Obj. kód 306470

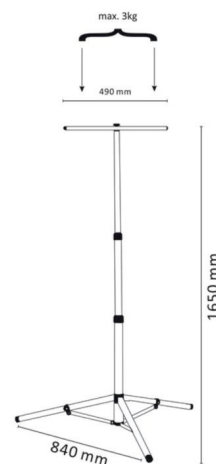

### UNI

materiál: kov  
Statív



obj. kód	typ	príslušenstvo	nosnosť	farba	rozmer (mm)
306470	UNI 165CM	statív	3 kg	žltá	840x490x1650

# Exteriérové



**TARA**

materiál:  
hliník, PC

LED

185-265 V

50/60 Hz

IP 65

30000 h



Ra>80



TARA 30W 4000K  
Obj. kód 3022840



TARA 50W 4000K  
Obj. kód 3022850



obj. kód	typ	W	lm	farba	farba svetla	rozmer (mm)
3022840	TARA 30W 4000K	30	2400	čierna	neutrálna	235,4x210,9x71
3022850	TARA 50W 4000K	50	4000	čierna	neutrálna	267,6x247x78,1

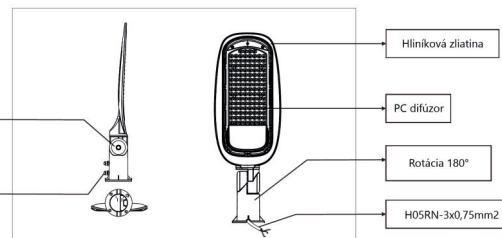
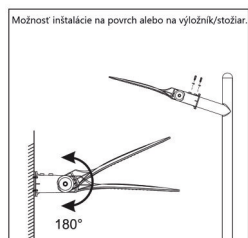
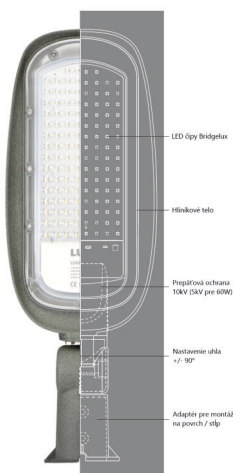

**STREET RX**

materiál:  
hliník, PC

LED

185-265 V

50 / 60 Hz



IP 65

6000 K



35000 h



Ra>70



STREET-RX 30W, obj. kód 62800403



STREET-RX 60W, obj. kód 62800406



STREET-RX 100W, obj. kód 62800410



obj. kód	typ	W	lm	rozmer (mm)	montáž na
62800403	STREET-RX 30W	30	3300	491x165x88	povrch/D50
62800406	STREET-RX 60W	60	6600	491x165x88	povrch/D54
62800410	STREET-RX 100W	100	11000	572x201x97	povrch/D62



## Exteriérové



### TIGER

materiál:  
hliník, PC

LED

100-265 V

50/60 Hz

4000 K

30000 h

Ra>70



IP 65



TIGER-30W 4000K IP65  
Obj. kód 3104400



TIGER-100W 4000K IP65  
Obj. kód 3104440



TIGER-50W 4000K IP65  
Obj. kód 3104420

obj. kód	typ	W	lm	farba	rozmer (mm)
3104400	TIGER-30W 4000K IP65	30	3600	šedá	364x152x77
3104420	TIGER-50W 4000K IP65	50	6000	šedá	411x152x77
3104440	TIGER-100W 4000K IP65	100	12000	šedá	483x186x84



### STREET MA

materiál:  
hliník, sklo

LED

90-264 V

50/60 Hz



6000 K

100000 h

Ra>70



IP 65



STREET-MA 30W, obj. kód 62800503



STREET-MA 60W, obj. kód 62800506



STREET-MA 100W, obj. kód 62800510

obj. kód	typ	W	lm	rozmer (mm)	montáž na
62800503	STREET-MA 30W	30	3600	397,5x156,3x74,9	D50
62800506	STREET-MA 60W	60	7200	452,5x186,4x67,1	D50
62800510	STREET-MA 100W	100	12000	534x257,4x71,4	D60



# Exteriérové



## GIRAFFE

materiál:  
hliník, PC

LED

100-240 V

50/60 Hz

4000 K

50000 h

Ra>70



IP 65



GIRAFFE-150W 4000K IP65  
Obj. kód 3104540



GIRAFFE-50W 4000K IP65  
Obj. kód 3104500



GIRAFFE-200W 4000K IP65  
Obj. kód 3104560



GIRAFFE-100W 4000K IP65  
Obj. kód 3104520

obj. kód	typ	W	lm	farba	rozmer (mm)
3104500	GIRAFFE-50W 4000K IP65	50	7500	šedá	444x160x75
3104520	GIRAFFE-100W 4000K IP65	100	15000	šedá	548x206x76
3104540	GIRAFFE-150W 4000K IP65	150	22500	šedá	636x248x76
3104560	GIRAFFE-200W 4000K IP65	200	30000	šedá	738x275x76



SONORA-120W 6000K IP65  
Obj. kód 3210290



SONORA-200W 6000K IP65  
Obj. kód 3210300

## SONORA

materiál:  
hliník, PC

LED

5V DC

6000 K

30000 h

Ra>80



IP 65



obj. kód	typ	W	lm	farba	rozmer (mm)
3210290	SONORA-120W 6000K IP65	120	1800	čierna	511x231x47
3210300	SONORA-200W 6000K IP65	200	2700	čierna	722x251x47



# Exteriérové



## HIGHBAY TECHOLED-2

materiál:  
hliník, plast

LED

100-277 V

50/60 Hz

5000 K

25000 h

Ra>80



IP 65



TECHOLED-2 100W 5000K  
Obj. kód 3022950



TECHOLED-2 150W 5000K  
Obj. kód 3022960



TECHOLED-2 200W 5000K  
Obj. kód 3022970

obj. kód	typ	W	lm	farba	rozmer (mm)
3022950	TECHOLED-2 100W 5000K	100	12000	čierna	D270x56,1
3022960	TECHOLED-2 150W 5000K	150	18000	čierna	D300x61,5
3022970	TECHOLED-2 200W 5000K	200	24000	čierna	D330x68,2



## HIGHBAY SPACE

materiál:  
hliník, plast

LED

100-277 V

50/60 Hz

5000 K

50000 h

Ra>80



IP 65



SPACE 100W 5000K  
Obj. kód 3022870



SPACE 150W 5000K  
Obj. kód 3022880



SPACE 200W 5000K  
Obj. kód 3022890

obj. kód	typ	W	lm	farba	rozmer (mm)
3022870	SPACE 100W 5000K	100	15000	čierna	D265x119
3022880	SPACE 150W 5000K	150	22500	čierna	D290,3x122,7
3022890	SPACE 200W 5000K	200	30000	čierna	D346,4x124,7



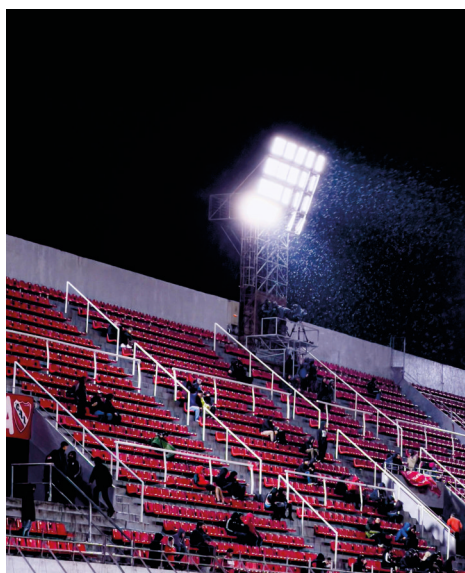
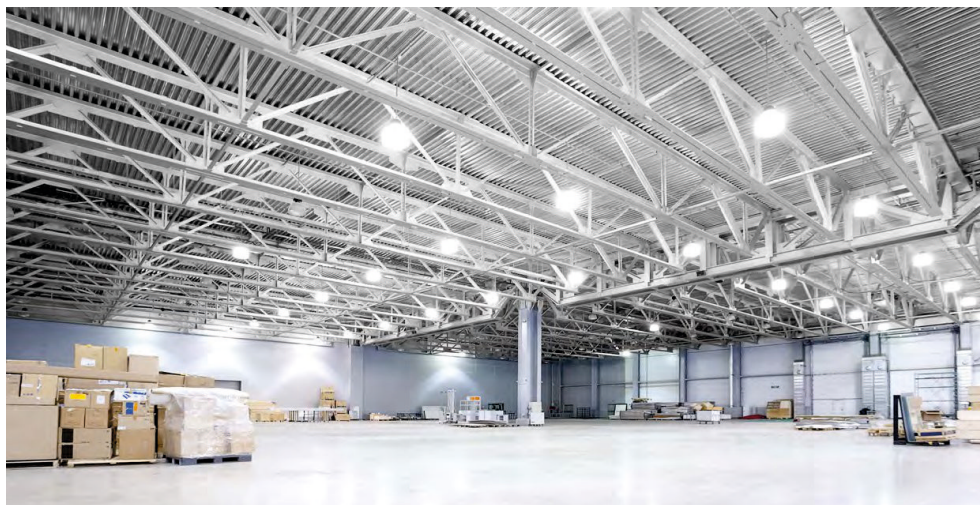



# Príslušenstvo



LAMPAS-01 WHT-YEL  
Obj. kód 5000360



LAMPAS-03 WHT-YEL  
Obj. kód 5000370



LAMPAS-07 WHT-GREY  
Obj. kód 5000410



LAMPAS-08 WHT-GREY  
Obj. kód 5000420

## LAMPAS

materiál: plast

LED

IP 20

RA>80

35000 h



LAMPAS-09 BLC-YEL  
Obj. kód 5000430



LAMPAS-11 BLC-GRN  
Obj. kód 5000450



LAMPAS-13 BLC-RED  
Obj. kód 5000470

obj. kód	typ	W	lm	svietenie	nabíjanie	batéria	farba
5000360	LAMPAS-01 WHT-YEL	25	500	1,5-20 h	4-6 h	3,7V 2000mAh Li	žltá, biela
5000370	LAMPAS-03 WHT-YEL	0,5+6	500	2,5-7 h	12-15 h	4V 900mAh LA	žltá, biela
5000410	LAMPAS-07 WHT-GREY	3+19	140	1,5-80 h	6-8 h	3,7V 1800mAh Li	biela
5000420	LAMPAS-08 WHT-GREY	1,4+3	140	2-10 h	4-6 h	3,7V 1200mAh Li	biela
5000430	LAMPAS-09 BLC-YEL	3	150	2-10 h	10-12 h	4V 900mAh LA	žltá, čierna
5000450	LAMPAS-11 BLC-GRN	2	125	1-4 h	10-12 h	4V 400mAh LA	zelená, čierna
5000470	LAMPAS-13 BLC-RED	2+5	300	2-4 h	12-15 h	4V 1600mAh Li	červená, čierna



FLASH-1 3W 6000K  
Obj. kód 5000480



FLASH-2 1W 6000K  
Obj. kód 5000490

## FLASH

materiál:  
FLASH-1: hliník  
FLASH-2, 3, 4:  
ABS, guma

LED

IP 44

RA>70

6000 K

25000 h



FLASH-3 3W 6000K  
Obj. kód 5000500



FLASH-4 3W 6000K  
Obj. kód 5000510

obj. kód	typ	W	lm	svietenie	nabíjanie	napájanie	farba
5000480	FLASH-1 3W 6000K	3	200	6 h	6 h	Li-ion 14500 400 mAh	čierna
5000490	FLASH-2 1W 6000K	1	15	4 h	-	2x AA	čierna, žltá
5000500	FLASH-3 3W 6000K	3	200	6 h	-	3x AA	čierna, oranžová
5000510	FLASH-4 1W 6000K	1	120	6 h	-	3x AA	čierna, červená



FLASH-5 1+2W 6000K  
Obj. kód 5000520



FLASH-6 1W 6000K  
Obj. kód 5000530

obj. kód	typ	W	lm	svietenie	napájanie	nabíjanie	farba
5000520	FLASH-5 1+2W 6000K	1+2	40+80	5 h	3x AA	5V DC USB	čierna
5000530	FLASH-6 1W 6000K	1	30	4 h	3x AA	-	čierna

## FALSH

materiál:  
ABS, guma

LED

IP 44

Ra>70

25000 h



ROSE GRN  
Obj. kód 5200360



ROSE WHT  
Obj. kód 5200380



BUTTERFLY BLU  
Obj. kód 5200390



BUTTERFLY GRN  
Obj. kód 5200400



SUN WHT  
Obj. kód 5200460



HEART WHT  
Obj. kód 5200500



BEE YEL  
Obj. kód 5200570



OWL-GR  
Obj. kód 5200690

obj. kód	typ	W	farba svetla	farba
5200360	ROSE GRN	4x0,1	zelená	trasparentná
5200380	ROSE WHT	0,4	studená biela	trasparentná
5200390	BUTTERFLY BLU	0,3	modrá	trasparentná
5200400	BUTTERFLY GRN	0,3	zelená	trasparentná
5200460	SUN WHT	0,4	studená biela	trasparentná
5200500	HEART WHT	0,3	studená biela	trasparentná
5200570	BEE YEL	0,3	RGB	žltá, čierna trasparentná
5200690	OWL-GR	5x0,1	studená biela	zelená

## SUN-BEE

materiál: plast

LED

220-240 V

50/60 Hz



15000 h

IP 21



Ra>80





# Príslušenstvo

## ZÁVES

materiál:  
plast

E27

230 V

50 Hz



IP 20



PENDANT-WH E27  
Obj. kód 7300200



PENDANT-BL E27  
Obj. kód 7300210

obj. kód	typ	V	W	farba	rozmer (mm)
7300200	PENDANT-WH E27	220-240 V	max. 40 W	biela	D37x70
7300210	PENDANT-BL E27	220-240 V	max. 40 W	čierna	D37x70



ESTELLE E27-100W GOLD  
Obj. kód 7320150



ESTELLE E27-100W BRONZ  
Obj. kód 7320160



ESTELLE E27-100W CHROM  
Obj. kód 7320180

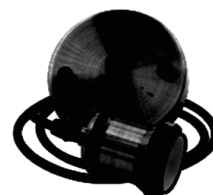

ESTELLE E27-100W BLACK  
Obj. kód 7320260

## ESTELLE

materiál: kov

E27

100 W

IP 20

220-240 V



50 Hz



obj. kód	typ	farba	rozmer (mm)
7320150	ESTELLE E27-100W GOLD	patina	D75x1000
7320160	ESTELLE E27-100W BRONZ	medená patina	D75x1000
7320180	ESTELLE E27-100W CHROM	chróm	D75x1000
7320260	ESTELLE E27-100W BLACK	čierna	D75x1000



MS07-WHT, obj. kód 6110100  
MS07-BLC, obj. kód 6110110



MS04-WHT, obj. kód 6110070



MS08-WHT, obj. kód 6110120

## SENZORY

materiál: plast

230 V

50 Hz



F



MS05-WHT, obj. kód 6110080



MW01, obj. kód 72136000

obj. kód	typ	farba	IP	°	W	obj. kód	typ	farba	IP	°	W
6110080	MS05-WHT	biela	20	360	400 W	6110100	MS07-WHT	biela	44	180	1200 W
6110070	MS04-WHT	biela	20	360	800 W	6110110	MS07-BLC	čierna	44	180	1200 W
72136000	MW01	biela	20	360	1200 W	6110120	MS08-WHT	biela	20	180	500 W



VENTI GRIL 12W D100MM  
Obj. kód 8005100



VENTI GRIL 12W D120MM  
Obj. kód 8005120



VENTI FLAT 12W D100MM  
Obj. kód 8005170



VENTI FLAT 12W D100MM BLACK  
Obj. kód 8005111

## VENTI

materiál:  
plast

220-240 V

50/60 Hz

12 W

100 m<sup>2</sup>/h

36 dB

2250 ot/m

IP 54

50000 h



-20°C  
až +40°C



obj. kód	typ	farba	rozmer (mm)
8005100	VENTI GRIL 12W D100MM	biela	D100x150x150
8005120	VENTI GRIL 12W D120MM	biela	D120x177x177
8005170	VENTI FLAT 12W D100MM	šedá	D100x150x150
8005111	VENTI FLAT 12W D100MM BLACK	čierna	D100x150x150



BELLA-1  
Obj. kód 5800050  
Farba: bielo-modrá



BELLA-2  
Obj. kód 5800060  
Farba: šedá



BELLA-3  
Obj. kód 5800070  
Farba: čierna



BELLA-6  
Obj. kód 5800080  
Farba: biela  
Detekcia: 3-7m, 100°



BELLA-7  
Obj. kód 5800090  
Farba: biela  
Detekcia: 3-7m, 100°



BELLA-4  
Obj. kód 5800100  
Farba: biela



BELLA-5  
Obj. kód 5800110  
Farba: biela

## ZVONČEK BELLA

materiál:  
plast ABS

IP20

obj. kód	typ	napájanie zvončeka	napájanie tlačítka	prenos/max. dosah	hlasitosť	optická sig.	rozmer (mm)
5800050	BELLA-1	3 V (2x AAA batérie)	12V V23GA	bezdrôtový/80 m	75 dB	áno	61x92x30
5800060	BELLA-2	4,5 V (3x AAA batérie)	12V V23GA	bezdrôtový/100 m	70-80 dB	áno	60x100x26
5800070	BELLA-3	220-240 V		bezdrôtový/100 m	70-80 dB	áno	80x120x30
5800080	BELLA-6	3 V (2x AAA batérie)	4,5V 3xAAA	bezdrôtový RF/130-150 m	70-80 dB	nie	
5800090	BELLA-7	4,5 V (3x AAA batérie)		bezdrôtový IR/ - 7 m	85 dB	nie	
5800100	BELLA-4	220-240 V vstup/12 V výstup		drôtový	80 dB	nie	108x170x51
5800110	BELLA-5	220-240 V		drôtový	80 dB	nie	98x168x42



# Vzduchové výplne

Zvýšenie bezpečnosti a zníženie reklamácií pri preprave tovaru



Zvýšenie rýchlosti balenia zásielok a zníženie nákladov na expedíciu



Zníženie hmotnosti balíkov a nákladov na prepravu



Zvýšenie čistoty na pracovisku



Zefektívnenie skladových priestorov



## STROJ NA VÝROBU VZDUCHOVÝCH VÝPLNÍ

materiál:  
KM-2001- kov, plast  
KM-4501- kov

220-240 V

50/60 Hz

prevádzka pri 16-43°C

skladovanie pri 0-43°C



IP 20



KM-2001, 200W  
Obj. kód 2001



KM-4501, 450W  
Obj. kód 2005

obj. kód	typ	W	rýchlosť	objem	šírka fólie	farba	rozmer (mm)	váha
2001	KM-2001, 200W	200	12m/min.	0-200 l/min.	max. 60 cm	šedo-zelená	410x360x280	5,5 kg
2005	KM-4501, 450W	450	28m/min.	1-100 l/min.	max. 80 cm	šedo-modrá	500x580x330	18 kg

# Vzduchové výplne



PILLOW 200X100MM, 300M  
Obj. kód 2018



PILLOW 200X150MM, 300M  
Obj. kód 2020



4TUBE 400X320MM, 300M  
Obj. kód 2030



BUBBLE 400X320MM, 300M  
Obj. kód 2040



BUBBLE 600X300MM, 300M  
Obj. kód 2050

obj. kód	typ	farba	dĺžka (m)	šírka (mm)	perforácia (mm)
2018	PILLOW 200X100MM, 300M	transparentná	300	200	100
2020	PILLOW 200X150MM, 300M	transparentná	300	200	150
2030	4TUBE 400X320MM, 300M	transparentná	300	400	320
2040	BUBBLE 400X320MM, 300M	transparentná	300	400	320
2050	BUBBLE 600X320MM, 300M	transparentná	300	600	300

## FÓLIA

materiál:  
HDPE

20 um



PILLOW 200X100MM, 40M  
Obj. kód 2118



PILLOW 200X150MM, 40M  
Obj. kód 2120



4TUBE 400X320MM, 40M  
Obj. kód 2130



BUBBLE 400X320MM, 50M  
Obj. kód 2140

obj. kód	typ	farba	dĺžka (m)	šírka (mm)	perforácia (mm)
2118	PILLOW 200X100MM, 300M	transparentná	40	200	100
2120	PILLOW 200X150MM, 300M	transparentná	40	200	150
2130	4TUBE 400X320MM, 300M	transparentná	2 x 20	400	320
2140	BUBBLE 400X320MM, 300M	transparentná	2 x 25	400	320

## VÝPLŇ

materiál:  
HDPE

20 um



KM001 - skúšačka žiaroviek  
Obj. kód 8205001



KM002 - stojan žiaroviek  
Obj. kód 8205002

obj. kód	typ	popis
8205001	KM001	skúšačka žiaroviek
8205002	KM002	stojan žiaroviek



KM004 - stojan podlinkových svietidiel  
Obj. kód 8205004



KM003 - panel LED sád  
Obj. kód 8205003



KM005 - stojan ZIKO  
Obj. kód 8205005

obj. kód	typ	popis
8205003	KM003	panel LED sád
8205004	KM004	stojan podlinkových svietidiel
8205005	KM005	stojan ZIKO

# Poznámky

A large grid of small dots for taking notes, covering most of the page. The dots are arranged in a regular pattern, forming a grid that is approximately 30 columns wide and 60 rows high.





Bucharova 2657/12, 15800 Praha 5  
Česká republika  
Mobil: +420 774 482 369  
Fax: +420 226 013 916  
E-mail: [info@svetidla-km.cz](mailto:info@svetidla-km.cz)  
[www.svetidla-km.cz](http://www.svetidla-km.cz)



Štefánikova 4082, 08501 Bardejov  
Slovenská republika  
Mobil: +421 908 040 455,  
+421 905 349 023  
Fax: +421 233 204 655  
E-mail: [svetidla@svetidla-km.sk](mailto:svetidla@svetidla-km.sk)  
[www.svetidla-km.sk](http://www.svetidla-km.sk)